



The Power of Loop Reduction: Planning, Engineering, & Commissioning Line Powered DSLAM Networks

Chapter 1: Introduction to Line Powered DSLAMs

An Alpha Technologies White Paper

by Kevin Borders
Director of Product Marketing

July 2016

Your Power Solutions Partner

CHAPTER 1: INTRODUCTION TO LINE POWERED DSLAMS

Most telecom service providers consider Fiber-to-the-Home (FTTH) to be the ultimate solution for competing with their Cable TV rivals. FTTH offers virtually unlimited bandwidth and is very affordable in new greenfield installations. But in the vast majority of installations, where twisted pair copper is still being used, it is too expensive to overlay the existing copper network with an end-to-end Passive Optical Network (PON) and FTTH. The shared portion of the PON is not the culprit; instead, it is the cost of replacing the ‘last mile’ connections to the individual customers that prohibits the universal deployment of FTTH.

Fortunately, the suppliers of DSL technology have continued to find ways to increase bandwidth delivery over copper. Advanced DSL technologies such as VDSL2 offer bandwidth up to 100Mbps, depending on the distance between the DSL Access Multiplexer (DSLAM) and the customer’s DSL modem. Some leading suppliers of DSLAMs have incorporated VDSL2 technology in small, sealed form-factors that serve between 12 and 48 subscribers. Known generically as Sealed DSLAMs or Mini-DSLAMs, these devices are usually connected to the Central Office with fiber optics (though copper can be used in some cases). The DSLAMs re-use the copper distribution and drop cables connecting the end users, resulting in competitive bandwidth rates at an affordable cost.

Many telcos have undertaken programs to install these VDSL2 terminals within a few thousand feet of their customers. Deploying the DSLAM deep into the network reduces the amount of copper between the DSLAM and the end users, which optimizes the bandwidth available from the VDSL2 terminal. Programs like these that shorten, or reduce, the copper loop in order to boost bandwidth delivery have come to be called Loop Reduction programs.

While the Mini-DSLAM is an ideal solution for delivering cost-effective broadband, there are some issues to address. Planners must determine the best location for each DSLAM to maximize coverage and bandwidth. Site selection often requires compromise as well, depending on the availability of easements or rights of way, the need to mount the device on a pole or in a cabinet, the site’s access to a copper distribution connection point like a cross-connect or pedestal, etc. On top of these factors, each DSLAM requires a source of reliable power.

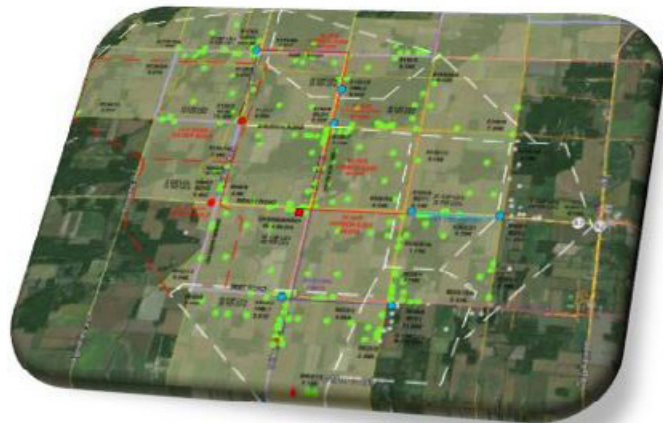

Loop reduction topographic map

The traditional approach is to power each terminal locally (“Local Power”). The Local Power approach uses electricity from the utility to connect to power conversion devices such as a rectifier or UPS, which in turn power the DSLAM. Backup power is provided by one or more batteries or battery strings. The power equipment, which often requires a separate cabinet along with a power meter for the utility company, must be accounted for in site selection. And when time is of the essence, such as in Connect America Fund (CAF) projects, interacting with a variety of local electrical utilities can become a cost and logistical impediment to building out a new broadband network.

In most installations, Mini-DSLAMs are served by fiber optic cables that connect back to the CO, replacing the copper cables that were used to provide POTS or CO-based ADSL services. Rather than retire or abandon these copper cables, many service providers are re-purposing them to deliver power from the CO to the DSLAMs. This powering technique is known as Line Power.

Line Power is a method of energizing remote electronics by using a centralized source of DC power (such as the CO power plant) to deliver current over copper cables. Many carriers have adopted this approach for powering DSLAMs in their CAF projects, in part due to the cost savings as well as the logistical benefits from not having to rely on the local electrical utility to supply AC power to the site. With line-powered DSLAMs, the telco controls its destiny when it comes to power and network deployment. In addition, Line Power offers several benefits as noted in Table 1.

Table 1**BENEFITS OF LINE POWER**

- Shortens time to market by eliminating the need to coordinate with local electrical utilities for power at each DSLAM site
- Lowers capital investment by eliminating the need for AC power at each DSLAM site
- Reduces operating expenses by avoiding the recurring charge for electrical service and avoiding truck rolls to replace batteries at the remote sites
- Enhances network reliability and resiliency by utilizing the rectifiers, batteries and generators located at the CO
- Protects the environment by eliminating the proliferation of batteries at the network edge

While Line Power is affordable and can be implemented quickly, it is not as prevalent and therefore not as well understood as Local Power methods. Line Power is a cross-over technology involving both Inside Plant and Outside Plant organizations. Typical concerns about Line Power include safety, the suitability of cables for delivering Line Power service, planning & engineering, and the nuances of connecting and commissioning a line-powered network. Regardless of the benefits of Line Power, these concerns must be addressed in order for it to gain universal acceptance as a solution for powering broadband/DSLAM networks.

As the foremost proponent of Line Power, Alpha Technologies has created an 8-part series on how to plan and engineer a line-powered DSLAM network. Using our experience with service provider CAF projects, we have created a comprehensive guide to aid in understanding how to use Line Power in a Loop Reduction program. In this white paper series, the underlying assumption is that DSL equipment will be placed closer to the customers, fed by either fiber or copper cables, and powered from a centralized location using copper cable pairs to deliver the Line Power.

The eight chapters planned for this White Paper series include:

- Chapter 1** Introduction to Line Powered DSLAMs
- Chapter 2** Planning Considerations for Line Powered DSLAMs
- Chapter 3** Determining the Reach for Line Powered DSLAM Networks
- Chapter 4** Qualifying Cable Pairs for Line Powered DSLAM Networks
- Chapter 5** Engineering the 48Vdc Plant to Power the Line Powered Equipment
- Chapter 6** Engineering the OSP Connections in a Line Powered DSLAM Network
- Chapter 7** Installing the Line Power Equipment
- Chapter 8** Commissioning the Line Power Equipment

SUMMARY

Many telecom service providers are using new VDSL2 Mini-DSLAMs and Loop Reduction techniques as a means of offering competitive broadband speeds to their customers. Reducing, or shortening, the amount of copper between the DSLAM and the customer maximizes the broadband speeds of the DSLAM terminals. To lower cost and improve time to market, these telcos are re-purposing the copper plant for use in delivering power to the DSLAMs using a method known as Line Power.

In the next chapter, we discuss some of the key planning considerations for deploying line-powered DSLAMs.

Alpha Technologies Ltd.

Canada: Burnaby, British Columbia • T: 604 436 5900 • F: 604 436 1233

United States: Bellingham, Washington • T: 360 647 2360 • F: 360 671 4936

Alpha Technologies reserves the right to make changes to the products and information contained in this document without notice.
Copyright © 2016 Alpha Technologies. All Rights Reserved. Alpha® is a registered trademark of Alpha Technologies.
member of The Alpha Group™ is a trademark of Alpha Technologies.

For more information visit www.alpha.ca

Rev A (07/2016)

member of The  Group™



The Power of Loop Reduction: Planning, Engineering, & Commissioning Line Powered DSLAM Networks

Chapter 2: Planning Considerations for Line Powered DSLAMs

An Alpha Technologies White Paper

by Kevin Borders
Director of Product Marketing

July 2016

Your Power Solutions Partner

CHAPTER 2: PLANNING CONSIDERATIONS FOR LINE POWERED DSLAMS

Using our experience with service provider Connect America Fund (CAF) projects, Alpha Technologies has created a comprehensive series of White Papers to outline how to use Line Power in a Loop Reduction program. This chapter addresses the planning considerations necessary for successful deployment of a Line Powered DSLAM network.

Some of the more important factors to be considered when planning a line powered DSAM network include: (1) the location of the Line Power equipment relative to the DSLAMs; (2) the type and condition of the copper cable pairs between the Line Power location and the DSLAM site; (3) the availability and capacity of the cable management devices; and (4) the capacity of the existing 48Vdc power system and batteries. Prior to delving into these topics, it is important to have a fundamental understanding of how Line Power works.

HOW LINE POWER WORKS

The basic block diagram of a Line Power circuit is provided in Figure 1. The Line Power equipment includes the Up-converter, which converts the 48Vdc voltage to $\pm 190\text{Vdc}$, and the Down-converter, which converts the $\pm 190\text{Vdc}$ voltage down to a voltage suitable for powering the load. In the case of Mini-DSLAMs, the down-converter functionality is built in to the DSLAM so that the OSP cable pair connects directly to the DSLAM. For safety considerations and in order to comply with standards for Line Power equipment, the maximum power delivered over a Line Power circuit is limited to 100 Watts. The maximum Tip-to-Ring voltage is 400Vdc, and the maximum voltage from Tip-to-Ground or Ring-to-Ground is 200Vdc. Like most vendors, Alpha limits the voltages to 380Vdc and 190Vdc, respectively, to allow for manufacturing tolerances.

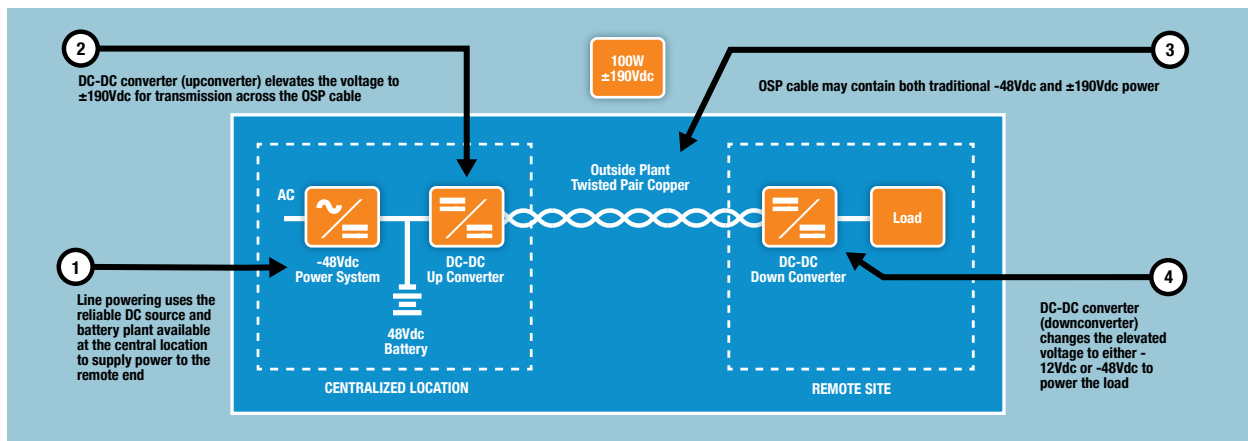

Figure 1. Line Power Block Diagram

DETERMINING THE LOCATION OF THE UP-CONVERTER EQUIPMENT

Once the Network Planners decide on the best location for the Mini-DSLAM to ensure optimal coverage, the location of the Up-converter equipment can be determined. The two Line Power deployment architectures - Home Run or Mid-Span – are both viable depending on the conditions in the exchange. The diagram in Figure 2 below depicts the two architectures.

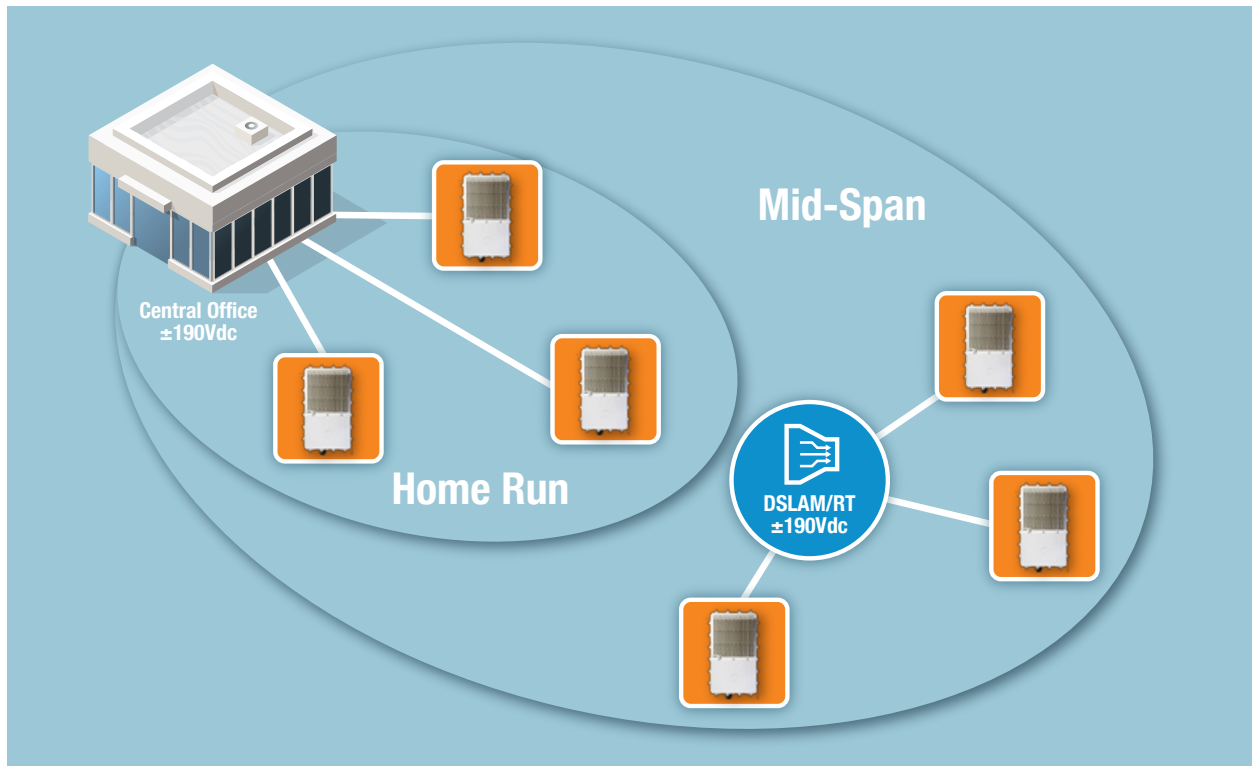

Figure 2. Line Powered DSLAM Architectures

HOME RUN ARCHITECTURE

In the Home Run architecture, the Line Power equipment is installed in the Central Office. The CO is an ideal site since it is a controlled environment with an existing power infrastructure including rectifiers, batteries and access to standby or portable generators. The Main Distribution Frame also provides a convenient and straightforward means of connecting the output of the Line Power equipment to the OSP cable pairs. See Figure 3 below for a diagram of a typical CO-based architecture.

While the Home Run architecture is preferred, it can only be used if (1) there are copper cable pairs available between the CO and the DSLAM; (2) the cable pairs are in good condition; and (3) the distance between the CO and DSLAM is within the serving capabilities of the Line Power equipment. If any of these three conditions is not met, the Mid-Span architecture is the recommended solution.

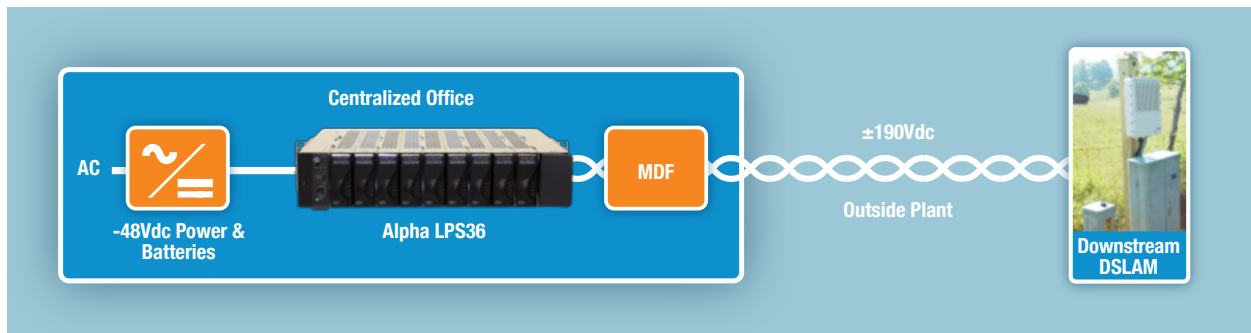

Figure 3. CO-Based Line Powered DSLAM Architecture

MID-SPAN ARCHITECTURE

In the Mid-Span architecture, the Up-converter equipment is located somewhere in the local loop i.e. outside of the CO. The Mid-Span architecture is bound by the same three conditions noted above. But since the location is much closer to the customers, there is a high likelihood of the three conditions being met.

Like the Home Run architecture, there must be a source of 48Vdc power for the Up-converter equipment. This source often can be found in an existing OSP enclosure such as a large DSLAM or Digital Loop Carrier (DLC) Remote Terminal. These enclosures usually include batteries in addition to the 48Vdc equipment, and also provide access to the OSP distribution cables.

When considering existing structures, there are four main requirements:

1. Capacity of the 48Vdc power plant and batteries, along with spare power distribution (e.g. circuit breaker or fuse)
2. Presence and capacity of OSP over-voltage protection (e.g. gas tube protectors)
3. Ability to access the OSP distribution cables
4. Available space for the Line Power Up-converter equipment

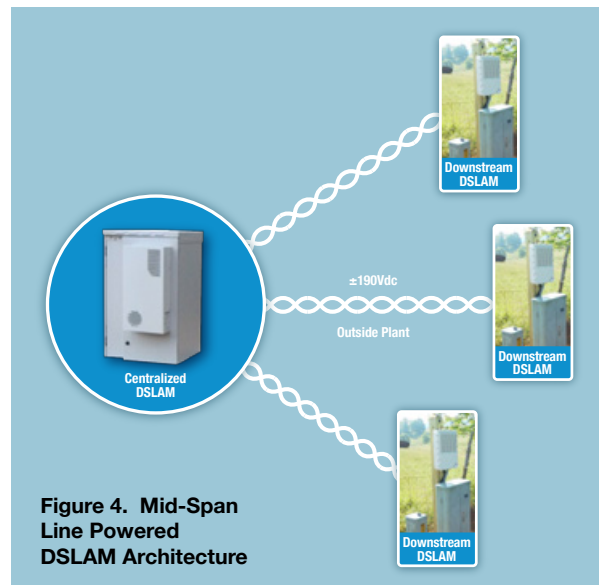

Figure 4. Mid-Span Line Powered DSLAM Architecture

Because of the diversity of OSP networks, there are several ways to satisfy the requirements for Line Powered DSLAM networks using the Mid-Span Architecture.

Hub and Spoke DSLAMs

In some areas, a centralized DSLAM located in the loop serves as a 'hub' for other, smaller DSLAMs (the 'spokes') located further downstream to serve more distant areas. Not only does the hub DSLAM provide transport connectivity, it may also supply the power to the downstream DSLAMs. The locally powered DSLAM hub can be equipped with sufficient 48Vdc power to energize Up-converter equipment that, in turn, line powers the downstream DSLAMs. Normally, the DSLAM vendor works with the Line Power vendor to design a packaged solution, ensuring the four requirements (48Vdc capacity, protection, access to cables, and space) are met prior to deployment.

Line Powering the Network Edge

Sometimes a community is built out in such a way that a cluster of living units is located at the far edge of the serving area. In these cases, the DSLAM is usually too far from the CO to be line powered. Moreover, the cluster of homes may be isolated from others making it impractical to use a DSLAM hub. Nevertheless, the DSLAM can still be line-powered, provided there is a powered Remote Terminal (RT) in the general vicinity. If an existing RT, such as a Digital Loop Carrier, is within the serving parameters for Line Power, and if there is a source of DC power available, then a Line Power module can be added to the RT to deliver power to the DSLAM located at the far edge of the network. Small, sealed Up-converter modules are available that can mount inside the RT or attach to the side of the cabinet or a nearby pole or pedestal. All of the qualifying requirements (48Vdc capacity, protection, access to cables, and space) apply, but are usually easily attainable because only a single up-converter module is being deployed. A diagram of this application is provided in Figure 5.

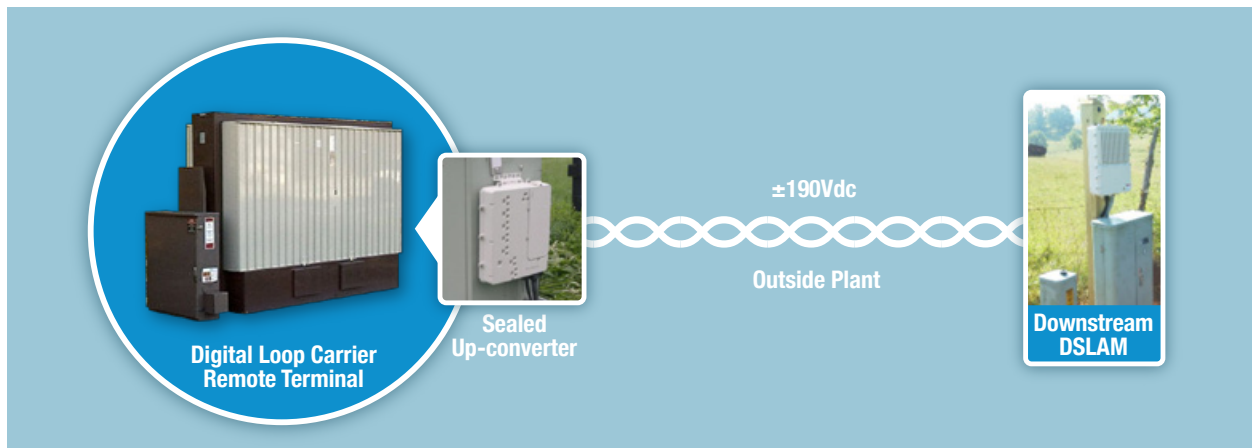

Figure 5. Mid-Span Architecture for Edge of Network

Remote Power Node (RPN)

When there is neither a DSLAM Hub nor an existing enclosure available to re-purpose for Line Power delivery, an alternative solution is to deploy a dedicated power hub called a Remote Power Node. The RPN is an OSP enclosure designed to house electronic equipment. It includes a means for terminating an AC electrical feed, a 48Vdc power and battery plant, a cross-connect equipped with gas tube protectors, and thermal management equipment to maintain a regulated environment. The size of the RPN varies based on the number of circuits served as well as the amount of battery backup required.

SUMMARY

There are multiple techniques for delivering Line Power to remote DSLAMs. Whether the Up-converter is located in the CO, in a Mid-Span location such as a DSLAM hub or RPN, or at the edge of the network, all of the qualifying conditions apply: (1) There must be copper cable pairs available between the CO and the DSLAM; (2) the pairs must be in reasonably good condition; (3) the distance between the CO and DSLAM must be within the serving capabilities of the Line Power equipment; and (4) there must be a source of 48Vdc power for the Up-converter equipment.



The Power of Loop Reduction: Planning, Engineering, & Commissioning Line Powered DSLAM Networks

Chapter 3: Determining the Reach

An Alpha Technologies White Paper

by Kevin Borders
Director of Product Marketing

August 2016

Your Power Solutions Partner

CHAPTER 3: DETERMINING THE REACH

Using our experience with service provider Connect America Fund (CAF) projects, Alpha Technologies has created a comprehensive series of White Papers to outline how to use Line Power in a Loop Reduction program. This chapter focuses on how to determine the capacity and reach of a Line Power circuit.

When Line Power is a consideration for use in powering DSLAM networks, one of the most frequently asked questions is “will it provide enough power to energize the DSLAM?” The answer depends on the output power of the Line Power up-converter, the characteristics of the cable, and the power consumed by the load equipment (DSLAM). One can determine the answer manually using a series of formulas or, easier still, by providing a few inputs to a vendor-provided calculator. This chapter will address both methods.

The planning engineer determines the location and type of DSLAM based on maximizing coverage for the serving area. The planner’s design provides insight to the three major variables in the calculation: the specific DSLAM model, the cable characteristics, and the type of Line Power up-converter equipment. The requisite specifications for the equipment are easily obtained from the equipment vendors. For the DSLAM, there are two specifications needed – the maximum power consumption and minimum operating voltage. Because of safety standards, Line Power circuits are limited to 100 Watts of power and 400Vdc of voltage across the cable pair. With these constraints, most up-converters will have similar specifications for output power and voltage. For example, Alpha’s Line Power System has a minimum output power of 96 Watts and nominal output voltage of 380Vdc.

The characteristics of the OSP cable, on the other hand, require a little work. The locations of the DSLAM and Up-converter define the overall cable distance, but the cable itself might consist of several sections. The sections vary based on length, cable gauge, and whether the cable is aerial or buried. This information can usually be obtained from OSP cable records. The characteristics of each section must be determined, then added together to find the power and voltage loss in the overall cable. Before discussing the Line Power formulas and the input requirements for vendor calculators, let’s establish the characteristics of OSP cable as it relates to Line Power circuits.

OSP CABLE ATTRIBUTES

There are three main attributes of OSP cable: cross-sectional area (gauge), cable temperature, and cable length. Each one is discussed below in terms of how it affects the Line Power calculations.

Cable Cross-sectional Area (Gauge): The cross-sectional area of a cable determines its current-carrying capacity.

In the same way a large water pipe will allow more flow than a small pipe, a cable with a larger cross-sectional area will allow more current to pass. In other words, a larger cross-sectional area offers less resistance to the flow of current.

Throughout North America and in many other regions, the cross-sectional area of a cable is defined by a standardized wire gauge system called American Wire Gauge (AWG). As shown in Figure 1, the lower the number of the gauge, the bigger the cable. For example, a 22AWG cable has a larger cross-sectional area than a 26AWG cable, and thus has a lower resistance. From a Line Power perspective, a 22AWG cable has a longer reach than a 26AWG cable.



Figure 1 Standard Cable Gauges

The most common cable gauges for OSP applications are 19, 22, 24 and 26 AWG. The resistance per kilofeet for each OSP cable gauge is provided in Table 1.

Cable Temperature: Cable resistance also varies with temperature. The higher the temperature, the higher the resistance. Aerial cable will usually operate at a higher temperature (and thus, higher resistance) than buried cable. In other words, a buried cable will have a longer reach in a line-powered circuit than an aerial cable, assuming the cable gauge is the same. The Line Power formulas include factors for temperature variations, though focusing on whether the cable is aerial or buried is usually sufficient. Limiting the choices to buried and aerial simplifies the equations while still providing the data necessary to make informed decisions on Line Power reach and capacity. This same technique is often used in vendor calculators. Table 1 includes the resistance for various OSP cable gauges for both aerial and buried cables.

Table 1. Resistance for OSP Cables		
Wire Size (AWG)	Ω / kft / pair	Ω / kft / pair
	Aerial (165°F)	Buried (65°F)
18	15.53	12.74
19	19.56	16.04
20	24.64	20.21
21	31.04	25.46
22	39.10	32.07
23	49.26	40.41
24	62.05	50.90
25	78.16	64.12
26	98.47	80.77

Cable Length: Revisiting the water pipe analogy, a shorter pipe would allow water to move through it more quickly than a longer pipe. So for copper cables, longer cables mean more resistance. The factors in Table 1 show resistance per kilofeet per pair. To calculate the total resistance of the cable pair, multiply the one-way distance (from Up-converter to DSLAM) by the resistance of the appropriate cable gauge for either aerial or buried cable.

MANUAL CALCULATIONS

Now that we understand cable attributes, we have all the information necessary to proceed with manual calculations for a Line Powered DSLAM circuit. Remember that the specific application defines the type of Up-converter and DSLAM equipment, and the location of the equipment determines the distance and make-up of the cable. Here are the step-by-step calculations:

1. Divide the maximum power consumption of the DSLAM (Watts) by the minimum operating voltage of the DSLAM (Volts) in order to derive the maximum operating current (Amps) in the cable.

$$P_{\max (\text{DSLAM})} \div V_{\min (\text{DSLAM})} = I_{\max (\text{cable})}$$

2. Determine the total resistance of the cable by multiplying the one-way distance (from Up-converter to DSLAM) by the resistance values found in Table 1. In this formula, "L" represents the one-way distance in kilofeet, "r" represents the resistance per kilofeet by AWG, and "R" represents the total resistance in the cable pair.

$$L_{(\text{cable, one-way})} \times r_{(\text{cable, 24AWG, buried})} = R_{\text{total (cable)}}$$

3. Using Ohm's Law ($V=IR$), the voltage drop in the cable can be determined by multiplying the current found in step 1 by the cable resistance found in step 2

$$I_{\max (\text{cable})} \times R_{\text{total (cable)}} = V_{(\text{cable})}$$

4. Subtract the voltage drop determined in Step 3 from the nominal voltage of the Up-converter (typically 380Vdc). If the number is greater than or equal to the minimum operating voltage of the DSLAM, the cable pair chosen can be used in a Line Power circuit to sufficiently power the DSLAM. If the number is not greater, then additional pairs are needed to reduce the total resistance in the cables.

$$V_{\max (\text{up-converter})} - V_{(\text{cable})} = V_{(\text{DSLAM})}$$

Let's run through an example that shows a single cable pair successfully powering a DSLAM. Afterwards, we will delve in to situations where additional pairs are needed.

Table 2. Distance Calculation Example #1		
Up-converter nominal voltage: 380Vdc DSLAM minimum operating voltage: 200Vdc DSLAM maximum power consumption: 45W		One-way cable distance: 6 kft Cable make-up: 24AWG, buried
Step 1	$P_{\max (\text{DSLAM})} \div V_{\min (\text{DSLAM})} = I_{\max (\text{cable})}$	$45W \div 200V = 0.225 \text{ Amps}$
Step 2	$L_{(\text{cable, one-way})} \times r_{(\text{cable, 24AWG, buried})} = R_{\text{total (cable)}}$	$6 \times 50.90 = 305 \text{ Ohms } (\Omega)$
Step 3	$I_{\max (\text{cable})} \times R_{\text{total (cable)}} = V_{(\text{cable})}$	$.225 \times 305 = 69 \text{ Volts}$
Step 4	$V_{\max (\text{up-converter})} - V_{(\text{cable})} = V_{(\text{DSLAM})}$	$380 - 69 = 311 \text{ Volts}$

Conclusion: Since 311 Volts is greater than the minimum operating voltage of this DSLAM (200V), a Line Power circuit using a single pair of 24AWG buried cable can adequately power the DSLAM located 6000 feet from the Up-converter unit.

Now let's consider the same conditions, but with a distance of 18kft.

Table 3. Distance Calculation Example #2		
Up-converter nominal voltage: 380Vdc DSLAM minimum operating voltage: 200Vdc DSLAM maximum power consumption: 45W		One-way cable distance: 18kft Cable make-up: 24AWG, buried
Step 1	$P_{\max(\text{DSLAM})} \div V_{\min(\text{DSLAM})} = I_{\max(\text{cable})}$	$45\text{W} \div 200\text{V} = 0.225\text{ Amps}$
Step 2	$L_{(\text{cable, one-way})} \times r_{(\text{cable, 24AWG, buried})} = R_{\text{total}(\text{cable})}$	$18 \times 50.90 = 916\text{ Ohms } (\Omega)$
Step 3	$I_{\max(\text{cable})} \times R_{\text{total}(\text{cable})} = V_{(\text{cable})}$	$.225 \times 916 = 206\text{ Volts}$
Step 4	$V_{\max(\text{up-converter})} - V_{(\text{cable})} = V_{(\text{DSLAM})}$	$380 - 206 = 174\text{ Volts}$

Conclusion: Since 174 Volts is less than the minimum operating voltage of this DSLAM (200V), a Line Power circuit using a single pair of 24AWG buried cable cannot adequately power the DSLAM. The additional cable length increases the total resistance in the cable to the point where there is not enough voltage left at the end of the cable to power the DSLAM. One can use Local Power instead of Line Power, but all the drawbacks of field-located batteries and logistical issues with electrical utilities still apply. Often, if additional cable pairs are available, a better solution is to bond two or more pairs together to reduce the amount of resistance in the cable.

CABLE BONDING

The technique for reducing cable resistance is by paralleling or bonding cable pairs, which is simply a matter of connecting on each end of the cable pair the Tip conductors and the Ring conductors. In Figure 2, the cable bonding concept is illustrated for two pairs.

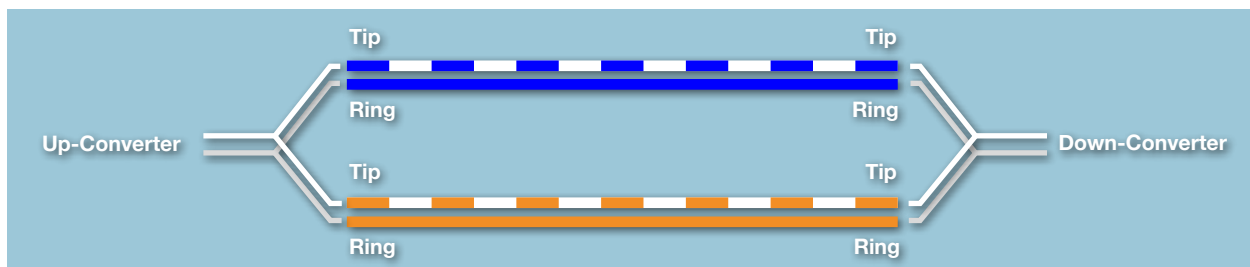

Figure 2. Paralleling Cable Pairs

This technique places the cable pairs in parallel which, in effect, increases the amount of copper in the path and thus lowers the resistance. This concept is shown mathematically by the following formulas:

Connecting two pairs $(R * R) / (R + R) = R/2$

Connecting three pairs $(R/2 * R) / (R/2 + R) = R/3$

...where R is the resistance of the cable pair in Ohms per kilofeet

Simply stated, paralleling two cable pairs cuts the resistance in half, paralleling three cable pairs reduces the cable resistance to one third of an individual pair, paralleling four cable pairs reduces the cable resistance to one fourth of an individual pair, etc. In other words, dividing the resistance of an individual cable pair by the number of paralleled cable pairs results in the total loop resistance. Conceptually, this makes sense because there is more of copper in the path, effectively increasing the total cross-sectional area and lowering the overall resistance to current flow. Let's look at Example #2 again, but this time with two bonded cable pairs.

Table 4. Distance Calculation Example #2 w/Bonded Pairs		
Inputs	Up-converter nominal voltage: 380Vdc DSLAM minimum operating voltage: 200Vdc DSLAM maximum power consumption: 45W	One-way cable distance: 18kft Cable make-up: 24 AWG, buried
Step 1	$P_{\max}(\text{DSLAM}) \div V_{\min}(\text{DSLAM}) = I_{\max}(\text{cable})$	$45\text{W} \div 200\text{V} = 0.225\text{ Amps}$
Step 2	$L_{(\text{cable, one-way})} \times r_{(\text{cable, 24AWG, buried})} = R_{\text{total}(\text{cable})}$	$18 \times 50.90 = 916\text{ Ohms } (\Omega)$
	$R_{\text{total}(\text{cable})} \div \#\text{bonded pairs} = R_{\text{total}(\text{cable})\text{-revised}}$	$916 \div 2 = 458\text{ Ohms } (\Omega)$
Step 3	$I_{\max}(\text{cable}) \times R_{\text{total}(\text{cable})\text{-revised}} = V_{(\text{cable})}$	$.225 \times 458 = 103\text{ Volts}$
Step 4	$V_{\max}(\text{up-converter}) - V_{(\text{cable})} = V_{(\text{DSLAM})}$	$380 - 103 = 277\text{ Volts}$

Conclusion: Since 277 Volts is more than the minimum operating voltage of this DSLAM (200V), a Line Power circuit using two bonded pairs of 24AWG buried cable can adequately power the DSLAM.

LINE POWER CALCULATORS

Equipment vendors have simplified the approach by embedding the formulas in easy-to-use calculators. Figure 3 provides a snapshot of Alpha's Line Power Calculator using the inputs from Example #1.

The yellow boxes represent the user inputs for the calculator. The white boxes can be left at the default setting, as these pertain to standalone down-converter rather than a DSLAM with an integrated down-converter.

Once the inputs are entered, proceed to the section called, "Select Allowable Voltage Drop." The slider bar allows you to calculate the allowable voltage drop and the impact it has on the remote end voltage. Moving the bar to the left decreases the allowable voltage drop, increasing the number of pairs per 100VA channel while reducing the number of 100VA channels required. This technique is often used when there are unused cable pairs available in order to reduce the number of Line

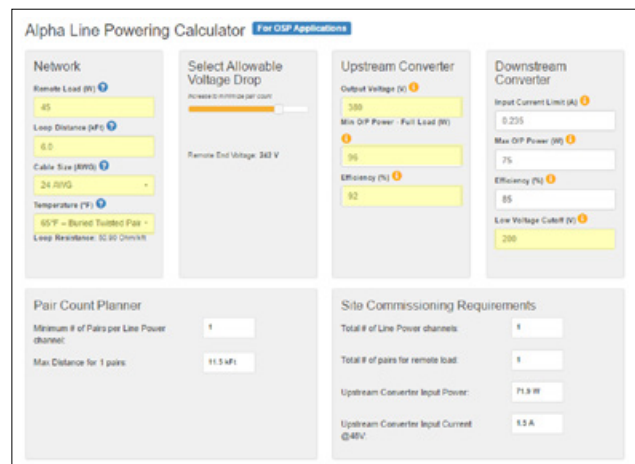

Figure 3 Line Power Calculator Results for Example #1

Power circuits and resulting equipment costs. Moving the bar to the right increases the allowable voltage drop, with the rightmost position of the slider bar corresponding to the low voltage cutoff (i.e. minimum operating voltage) which was entered previously. This has the effect of reducing the pair count while increasing the overall number of Line Power circuits. This technique is often used when there are minimal available pairs accessible and adding additional 100VA circuits is possible.

The two lower boxes provide the results of the exercise. The box on the left shows the minimum number of pairs per Line Power circuit as well as the maximum distance this configuration could be deployed. In the example above, we see that a single 100VA circuit connected with one 24AWG cable pair could actually reach up to 11.5kft, or nearly twice as far as the sample application.

The box on the right contains information to help define equipment requirements. In addition to the number of Line Power circuits required, it also provides the power consumption of the Line Power equipment in both Watts and Amps. This information is helpful in determining if and to what extent the 48V power plant and batteries need to be augmented.

SUMMARY

Once the DSLAM site is determined and the equipment list identified, it is rather easy to determine if a Line Power circuit can power the device. In some cases, the distance or load size may exceed the requirements of one Line Power circuit served by a single cable pair. We learned that it's possible to bond cable pairs to lower the overall cable resistance, in effect increasing the reach of the single Line Power circuit. We can obtain the results through manual calculations based on our DSLAM, Up-converter and cable characteristics. But vendor-provided calculators make the process even easier. In Chapter 4, we will learn how to qualify cable pairs to ensure they are suitable for Line Power circuits.

As the foremost proponent of Line Power, Alpha Technologies has created an 8-part series on how to plan and engineer a line-powered DSLAM network. The outline for the entire series is provided below:

The eight chapters planned for this White Paper series include:

- Chapter 1** **Introduction to Line Powered DSLAMs**
- Chapter 2** **Planning Considerations for Line Powered DSLAMs**
- Chapter 3** **Determining the Reach for Line Powered DSLAM Networks**
- Chapter 4** **Qualifying Cable Pairs for Line Powered DSLAM Networks**
- Chapter 5** **Engineering the 48Vdc Plant to Power the Line Powered Equipment**
- Chapter 6** **Engineering the OSP Connections in a Line Powered DSLAM Network**
- Chapter 7** **Installing the Line Power Equipment**
- Chapter 8** **Commissioning the Line Power Equipment**

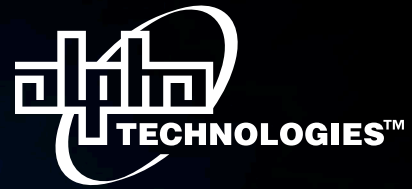

The Power of Loop Reduction: Planning, Engineering, & Commissioning Line Powered DSLAM Networks

Chapter 4: Qualifying Cable Pairs for Line Powered DSLAM Networks

An Alpha Technologies White Paper

by Kevin Borders
Director of Product Marketing

August 2016

Your Power Solutions Partner

CHAPTER 4: QUALIFYING CABLE PAIRS FOR LINE POWERED DSLAM NETWORKS

Using our experience with service provider Connect America Fund (CAF) projects, Alpha Technologies has created a comprehensive series of White Papers to outline how to use Line Power in a Loop Reduction program. This chapter focuses on how to qualify cable pairs for use in Line Power circuits.

Because of the age and condition of OSP cable deployed in many exchanges, there may be questions about the ability of the OSP cable to reliably support Line Power circuits. These concerns are similar to the ones voiced when T1 circuits were introduced. Can the cable pairs support the elevated voltages? Is the cable too old to be used for Line Power? How do qualification tests for Line Power compare to POTS or DSL? This chapter provides answers to these questions and provides instruction on how to verify that cable pairs can be used to deliver Line Power service.

CAN THE CABLE SUPPORT ELEVATED VOLTAGES?

Communications cables are not formally voltage rated nor listed as such by any listing or testing agency. But for decades, OSP cables have been used to transport $\pm 130\text{Vdc}$ (T1 lines as well as coin return/coin collect on payphones), -190Vdc (Fiber-to-the-curb lines), and $\pm 190\text{Vdc}$ (DSLAM, Fiber-to-the-Home) with no systemic evidence of premature degradation of cable performance. Nevertheless, older cables should be tested with a megohmmeter to ensure that there is no insulation breakdown. This is one of the tests specified in Alpha's Line Power Qualification Test procedure found below.

CAN LINE POWER CIRCUITS TOLERATE WATER INTRUSION, LOAD COILS AND BRIDGE TAPS?

Water intrusion is bad for outside plant cables and splices in general, increasing the likelihood of problems in the OSP cable such as corrosion damage to the plant, increased maintenance costs, dielectric breakdown, and service interruptions from noise or power ground faults. Line Power circuits are also adversely affected by water intrusion. Because gel-filled (e.g., PIC cables) and dry-block cables are generally more resistant to water intrusion than air core cables, they are preferred for use with Line Power systems. Air-core and pulp cables are more prone to water intrusion. When used for Line Power circuits, additional precautions (e.g., verifying cable pressurization) are needed to ensure the cable pairs are water free.

Load Coils are inductors used in analog (voice) telephone systems over long cable lengths to counteract the capacitance in the line, effectively tuning the circuits and reducing the total amount of cable loss at voice frequencies. They were often deployed on voice or analog lines in excess of 18 kft. Naturally, they were especially prevalent in rural areas where CAF-II DSLAMs may now be located.

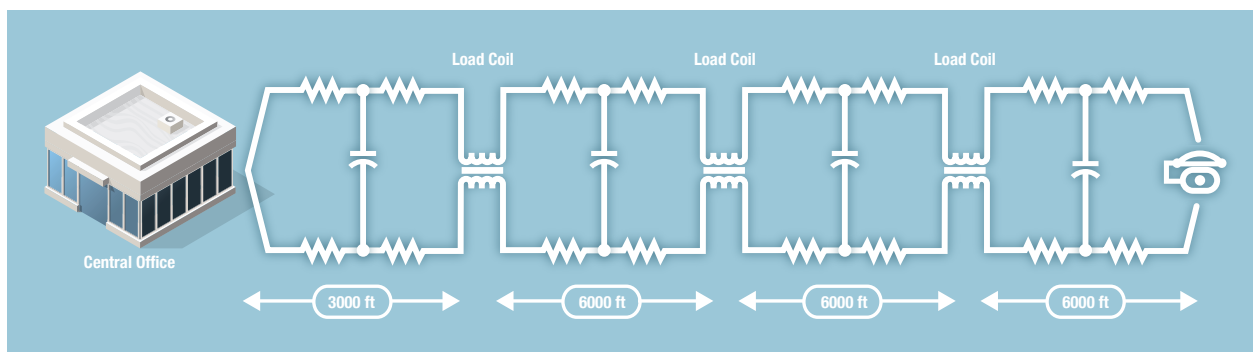

Load coils are passive devices placed in series with both the Tip and Ring conductors. Since Line Power is a DC-only circuit, it will pass through a load coil. However, each load coil does add a small amount of resistance ($\sim 6\Omega$) to the circuit. With several load coils in a long loop, the cumulative resistance could affect decisions on the number of cable pairs needed for the circuit. Also, the resistance of load coils is not factored into Line Power calculators like the one mentioned in Chapter 3, so it could skew the results of the calculator. Rather than try to determine if load coils will significantly affect the calculations, most carriers opt to remove them as a general practice. Though not mandatory, the best practice is to remove load coils from a Line Power circuit.

Bridge Taps are effectively splices with a 2-wire input and 4-wire output. The 2-wire input is the cable pair coming from the CO. The 4-wire output often occurs during new customer adds. When the technician connects or “taps” the customer drop wire to the OSP cable pair, he or she may not cut off the rest of the cable pair that extends the length of the cable. The reasoning is that the cable pair may be needed for another customer if/when this one moves out. This technique avoids the need for additional splices in cable pairs and shortens the time to turn up new service.

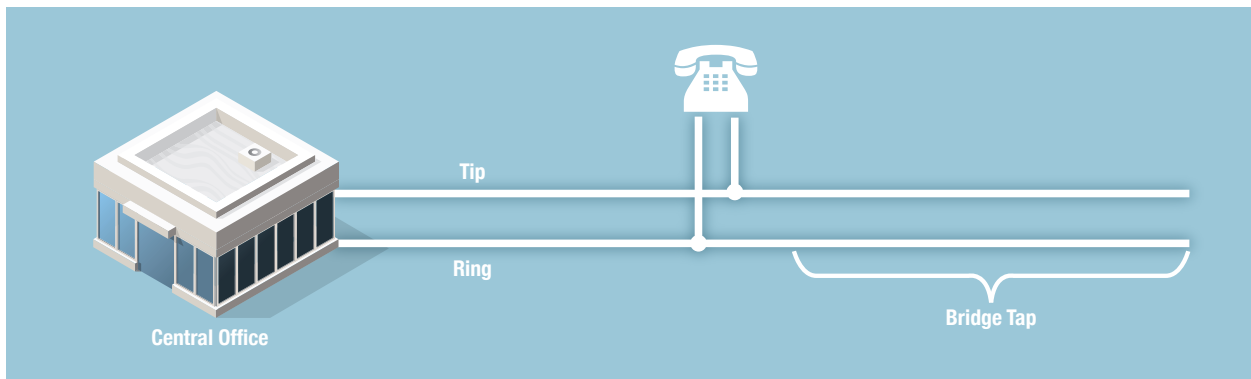

As long as a bridge tap remains unterminated, it will not affect a Line Power circuit. However, if a fault such as a short or cross were to occur on the bridge tap, it could short the path between the up-converter and DSLAM and cause the Line Power circuit to shut down. Not only does this affect the Line Power service, but complicates troubleshooting the cause of the problem. For that reason, it is a best practice to remove bridge taps prior to deploying a Line Power circuit.

HOW DO QUALIFICATION TESTS FOR LINE POWER COMPARE TO POTS OR DSL?

Line Power circuits designated to power DSLAMs differ from POTS, DSL, and T1 circuits, in that they are used exclusively for delivering DC power to the DSLAMs. Because a Line Power circuit is not used for voice or data transmission, many common tests are not required. There is no need to test for Power Influence, Circuit Noise, Attenuation, or Longitudinal Balance, though the latter can be helpful in diagnosing cable fault conditions. In addition to simplifying the acceptance procedure and reducing the time required to qualify the pair, a major benefit of Line Power circuits is that crosstalk is not a consideration. This enables the Line Power circuits to be deployed in the same binder group as other circuits such as POTS, DSL, and T1.

CABLE PAIR QUALIFICATION TESTS FOR LINE POWER CIRCUITS

In designing the Line Powered DSLAM circuit, the best practice is to certify the cable pair(s) for use prior to the installation. Alpha Technologies offers a test method, called the “Cable Qualification Procedure for $\pm 190\text{Vdc}$ Line Power Circuits,” that can assist the technician in determining if the cable pair is suitable for service. The procedure can be found [here](#).



The cable qualification procedure calls for a range of tests, including AC voltage, DC voltage, insulation resistance, and DC loop resistance. Most of the tests can be performed with a conventional multifunction test set, analog volt-ohm meter or Digital MultiMeter. For insulation resistance, a megohmmeter is required. In each case, the technician is instructed to follow a series of steps to verify the capabilities of the cable pairs. If a test results in a fault condition, the technician is instructed to follow his or her company's local practices for clearing the fault. Once the fault condition is resolved, then the testing can proceed where the technician left off.

Test #1 AC Voltage

AC voltage is the first test for safety reasons, since the presence of stray AC voltage may be the cause of a pair crossed with an electric utility line. External factors such as power lines can affect twisted pair OSP telephone lines, with the AC from these external factors often appearing as longitudinal currents flowing along the cable, seeking a path to ground. Small amounts of AC voltage on the pair may be tolerable. But if the voltage exceeds 10Vac, fault analysis needs to be performed as there could be a problem involving grounding, bonding or perhaps a crossed pair with a line from the electric power company.

Test #2 DC Voltage

Ideally, a non-working pair should have zero DC voltage since no DC source is connected to it. Stray or foreign DC voltage on a non-working pair is usually the result of a short circuit connection to another conductor in the cable. It could also come from a high resistance leakage path to other conductors due to water in the cable. For any voltage $\geq 3\text{Vdc}$ measured across Tip-Ground, Ring-Ground, or Tip-Ring, Alpha recommends additional troubleshooting.

Test #3 Insulation Resistance

Insulation resistance is a measure of the DC isolation between a conductor and other conductors in the cable. It is also a measure of the DC isolation between the conductor and the cable shield (ground). The insulation on the conductors has to be intact in order to prevent high-resistance faults. Possible causes of discontinuity in the insulation include aging, exposure to the elements (e.g., water), nicks or scrapes from improper handling, or piercing by a connector. An opening in the insulation can also allow moisture to penetrate to the copper and cause corrosion and high-resistance faults. For any resistance $\leq 100\text{M}\Omega$ measured across Tip-Ground, Ring-Ground, or Tip-Ring, Alpha recommends additional troubleshooting.

Test #4 DC Loop Resistance

The DC loop resistance of a pair is the resistance measured between the tip and ring conductors with the far end of the pair shorted. This test can be used to compare the measured resistance to the calculated resistance of the loop. It also verifies end-to-end continuity in the cable.

RULE OF THUMB

With Line Powered DSLAMs, especially those used in CAF-II projects, the cable pairs that will be used for power often were recently used for POTS or ADSL service. A general rule is that any pair suitable for POTS or ADSL can be used for Line Power, provided the distance is not too far for the equipment. However, cable pairs with paper or pulp insulation could become a problem unless the splices and pressurization are excellent; otherwise, there is a risk of water intrusion in the cable which will surely be found by the elevated voltage of the Line Power circuit.

SUMMARY

While most cable pairs are suitable for use with Line Power circuits, there are some precautions that can improve the likelihood of success. The pairs should be free from water intrusion, bridge taps, and load coils. When considering a Line Power circuit, the cable pairs can be pre-qualified by performing a series of four tests – AC voltage, DC voltage, insulation resistance, and loop resistance – on the candidate cable pair. When these tests cannot be performed, a rule of thumb is that any pair that has recently been used for POTS or DSL service can be used for Line Power. In Chapter 5, we explore how to engineer the 48Vdc plant to power the Line Powered equipment.

As the foremost proponent of Line Power, Alpha Technologies has created an 8-part series on how to plan and engineer a line-powered DSLAM network. The outline for the entire series is provided below:

The eight chapters planned for this White Paper series include:

- Chapter 1** **Introduction to Line Powered DSLAMs**
- Chapter 2** **Planning Considerations for Line Powered DSLAMs**
- Chapter 3** **Determining the Reach for Line Powered DSLAM Networks**
- Chapter 4** **Qualifying Cable Pairs for Line Powered DSLAM Networks**
- Chapter 5** **Engineering the 48Vdc Plant to Power the Line Powered Equipment - *Coming Soon***
- Chapter 6** **Engineering the OSP Connections in a Line Powered DSLAM Network - *Coming Soon***
- Chapter 7** **Installing the Line Power Equipment - *Coming Soon***
- Chapter 8** **Commissioning the Line Power Equipment - *Coming Soon***



The Power of Loop Reduction: Planning, Engineering, & Commissioning Line Powered DSLAM Networks

Chapter 5: Engineering the 48Vdc Power Plant

An Alpha Technologies White Paper

by Kevin Borders
Director of Product Marketing

November 2016

Your Power Solutions Partner

CHAPTER 5: ENGINEERING THE 48VDC POWER PLANT

Leveraging our experience with service provider Connect America Fund (CAF) projects, Alpha Technologies has created a comprehensive series of White Papers to outline how to use Line Power in a Loop Reduction program. This chapter focuses on how to engineer the 48Vdc power plant to power the Line Power circuits.

In conventional telco applications, DC-DC converters and the loads they are powering are located in the same building. However, with Up-converters, the DC-DC converters used in Line Power circuits, the loads are often thousands of feet away connected by OSP cables of varying length, make-up, and quantity. Because most DSLAMs are constant power devices, the amount of power delivered by the Up-converter varies by application. Consequently, the amount of 48Vdc power required by the Up-converters varies as well.

The simplest, and most conservative, approach to calculating the amount of power required by the 48Vdc plant is to assume every Line Power circuit is operating at maximum power. But using maximum power consumption for each circuit is not realistic and will undoubtedly result in oversizing the 48V power plant and batteries. Alpha Technologies has analyzed different applications based on the presumed load size and the distance from the Up-converter. This analysis helped us develop recommendations on power consumption for Line Power equipment.

The rest of this paper demonstrates how to calculate the 48V power requirements, then discusses the impact of using the theoretical maximum versus a practical method for sizing the plant.

HOW TO CALCULATE POWER REQUIREMENTS

There are four steps to calculate the power requirement for a Line Power application.

Step 1: Determine the capacity of the Up-converter equipment.

The best practice is to design the 48Vdc power plant and batteries to serve the maximum capacity of the Up-converter equipment. Although the number of line powered circuits needed up front may be less than the Line Power equipment capacity, designing the supporting power equipment for maximum capacity ensures the availability of power if, or when, additional line power circuits are added in the future.

A variety of solutions are available, including a 23-inch, 48-circuit shelf; a 19-inch, 36-circuit shelf; a 4-module, 16-circuit applique; and a sealed 4-channel module. For our example, we will use the 19-inch, 36-circuit shelf.

Step 2: Determine the input power requirements for the Up-converter equipment.

To determine the input power (P_{in}) requirements, the three key pieces of information needed are:

- (1) the nominal output power of the Up-converter circuit
- (2) the efficiency of the Up-converter
- (3) the total number of circuits at full capacity.

Items 1 and 2 can be obtained from the vendor data sheet, and item 3 from the type of Up-converter shelf being used. For our example, we will assume 96 Watts of output power (P_{out}), 92% efficiency, and a 19-inch, 36-circuit shelf.

Output power is determined by multiplying the input power by the efficiency of the Up-converter equipment. Using that formula, we can then derive the amount of input power required as shown in the box:

In this example, approximately 3.8kW of 48Vdc power is needed to power the Up-converter equipment. Often, the Line Power equipment can be powered using the excess capacity in the office. If excess capacity is not available, then the 48Vdc power equipment would need to be augmented. **Note that these numbers do not take into account augments for the battery plant or the requirements for recharging the batteries.** The battery requirements should be determined based on individual company practices for recharge and backup.

Input Power Calculations
Pin * Efficiency = Pout
Pin = Pout ÷ Efficiency
Pin = 96W ÷ 92% = 104.3W
Total Input Power = 36 * 104 = 3757W

Step 3: Sizing the Fuse or Circuit Breaker for the 48Vdc Input

Each connection from the 48Vdc plant to the Line Power equipment should include an overvoltage protection device such as a fuse or circuit breaker. The Line Power system is a DC-DC converter and appears as a load on the 48V rectifier plant. When AC power is unavailable to the 48V plant, the Line Power system will be powered by batteries that will operate until they reach their prescribed cut-off voltage, which is often 42Vdc. To size the input fuse, the Total Input Power must be divided by 42Vdc in order to determine the input current requirements during an AC outage. Using our example above, we divide 3757 Watts by 42 Volts and arrive at an input current rating of 89 Amps.

High capacity Up-converter shelves such as the 19-inch shelf in this example have dual inputs, with each input supplying power to a specific group of Up-converter modules. In this case, the value for total input current must be divided in half to determine the fuse requirements for each input. Dividing the 89 Amps in half results in an input current requirement of 45 Amps. Many service providers size protection devices at 125% of the peak load. In our example, the protection device should be at least 56 Amps (45 Amps x 1.25). Typical DC fuse sizes are 50 Amp and 60 Amps, so in this example the fuse would be sized at 60 Amps.

Step 4: Sizing the Input Cabling for the Up-converter Equipment

The input cabling must be sufficiently sized to carry the current. Cable ampacity should always equal to or exceed the protector size. In this example, the input cabling must be able to carry at least 60 Amps of current. Based on the table for standard wire gauge and ampacity ratings, we can determine that the minimum cable gauge for this application is #6AWG, which is rated for 65 Amps of current.

To summarize the four steps, the 19-inch, 36-circuit shelf is capable of consuming up to 3757 Watts of power. At the 42Vdc low-voltage cutoff for batteries, the amount of current consumed by the Line Power equipment is 89 Amps. Since the shelf has dual inputs, the total input current per input is 45 Amps. The result is a 60 Amp fuse and #6AWG cable per input is required to accommodate the maximum consumption of 45 Amps per feed.

Wire Gauge Table & Ampacity Ratings			
AWG	mm	Circular Mil Area (CMA)	Typical Current Rating (Amps)
18	0.75	1,620	5
16	1.5	2,580	10
14	2.5	4,110	15
12	4	6,530	20
10	6	10,380	30
8	10	16,510	45
6	16	26,240	65
4	25	41,740	85
2	35	66,360	115
1	50	83,690	130
0		105,600	150
00	70	133,100	175
000	95	167,800	200
0000	120	211,600	230
250MCM		250,000	
300MCM	150	300,000	285
350MCM	185	350,000	310
400MCM		400,000	335
500MCM	240	500,000	380
600MCM		600,000	420
700MCM	300	700,000	460
750MCM	400	750,000	475

THEORETICAL VS PRACTICAL DESIGN METHODS

The theoretical method assumes that all of the Line Power circuits operate at maximum output. That technique was on display in the previous section. The presumption was that each circuit was operating at its maximum output power of 96 Watts. This method is certainly the safest approach when designing a Line Power system, but will probably cost more. Based on the empirical evidence obtained from many Line Power deployments, Alpha believes there is an alternative approach that satisfies the requirements for protection and safety while minimizing cost.

Alpha Technologies has developed a practical method, a design technique which takes into account the likelihood of varying distances, cable make-up, and power consumption by the DSLAM. We know that Line Power systems draw less current when the converters are powering lower power loads as well as when the loads are closer to the Up-converter. So, instead of assuming each converter circuit operates at maximum output power, Alpha's practical method assumes a mix of output ranges.

For DSLAM networks such as those used in Loop Reduction and/or CAF-II programs, we assume the DSLAM consumes 50 Watts and is connected by 10kft of 24AWG cable. This scenario results in a circuit loading of 85% to approximate a typical DSLAM application. For FTTH networks, we assume the ONT consumes 20W and is connected by 20kft of 24AWG cable. In this scenario, loading the Line Power circuits at 60% will approximate a typical FTTH network.

Calculations

In the earlier example, the output power consumption per circuit was 96 Watts at maximum capacity. For DSLAM networks, that value is multiplied by 85%; for FTTH networks, the value is multiplied by 60%. The table below depicts the results for the theoretical approach as well as the practical method for DSLAM and FTTH networks.

		Theoretical	Practical Method	
		Method	DSLAM	FTTH
Maximum power consumption per circuit	Watts	96	96	96
Design factor		100%	85%	60%
Planned power consumption per circuit	Watts	96	82	58
Number of circuits per 19-inch shelf		36	36	36
Converter efficiency		92%	92%	92%
Input power required per circuit	Watts	104	89	63
Total input power required per shelf	Watts	3757	3193	2254
Total input current required per shelf	Amps	89	76	54
Input current required per dual feed	Amps	45	38	27
Fuse factor for peak load		125%	125%	125%
Fuse requirement per dual feed	Amps	56	48	34
Fuse size based on standard fuses	Amps	60	50	40
Cable size per dual feed	AWG	#6	#6	#8

The practical method reduces the requirements for rectifiers and fusing, and in the case of FTTH networks, the input cabling requirement. Further adjustments may be possible based on the specifics of the application.

SUMMARY

The DC-DC converter (Up-converter) used in a Line Power application is different than a conventional DC-DC converter. The output power of the Up-converter changes based on the load, which includes a constant power DSLAM along with OSP cables that vary in length and make-up. The simple and straightforward approach to determining the requirements for the 48Vdc power equipment is to assume the Up-converter supplies maximum power to the cable pairs. This theoretical, conservative approach can increase cost however, as the rectifiers, batteries, input fuses, and input cables may be oversized for the application. Alpha offers some practical design techniques – one for DSL networks and one for FTTH networks – that more closely match the actual load requirements.

In Chapter 6, we explore how to engineer the OSP connections in a Line Powered DSLAM network.

As the foremost proponent of Line Power, Alpha Technologies has created an 8-part series on how to plan and engineer a line-powered DSLAM network. The outline for the entire series is provided below:

The eight chapters planned for this White Paper series include:

- Chapter 1** **Introduction to Line Powered DSLAMs**
- Chapter 2** **Planning Considerations for Line Powered DSLAMs**
- Chapter 3** **Determining the Reach for Line Powered DSLAM Networks**
- Chapter 4** **Qualifying Cable Pairs for Line Powered DSLAM Networks**
- Chapter 5** **Engineering the 48Vdc Plant to Power the Line Powered Equipment**
- Chapter 6** **Engineering the OSP Connections in a Line Powered DSLAM Network - *Coming Soon***
- Chapter 7** **Installing the Line Power Equipment - *Coming Soon***
- Chapter 8** **Commissioning the Line Power Equipment - *Coming Soon***

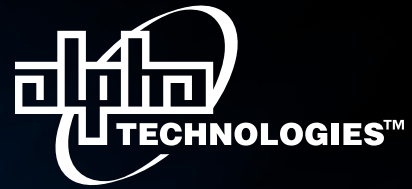

The Power of Loop Reduction: Planning, Engineering, & Commissioning Line Powered DSLAM Networks

Chapter 6: Engineering the OSP Connections

An Alpha Technologies White Paper

by Kevin Borders
Vice President of Marketing

February 2017

Your Power Solutions Partner

CHAPTER 6: ENGINEERING THE OSP CONNECTIONS

Leveraging our experience with service provider Connect America Fund (CAF) projects, Alpha Technologies has created a comprehensive series of White Papers to outline how to use Line Power in a Loop Reduction program. This chapter (#6 in our 8-chapter series) focuses on how to engineer the OSP connections.

A line powered DSLAM network includes three major points where cable connections take place: (1) the connections to the Up-converter – either in the Central Office or at a Remote Cabinet; (2) the connections to the DSLAM; and (3) all the OSP splice points in between. For circuit continuity, it is important to understand where and how to make these connections. It is also essential to properly identify and mark the connections so that other technicians are aware of the presence of elevated voltages in the cable pairs. In addition to discussing the connection and marking techniques, this chapter addresses how to connect bonded cable pairs to increase the reach of the Line Power equipment.

UP-CONVERTER CONNECTIONS

An Up-converter system can be deployed either in a controlled environment building such as a Central Office or in an OSP cabinet. The electrical performance of the Line Power equipment and the circuits are the same, but planning and designing the connections differ for each application.

CO Applications

In the CO, the Up-converter shelf connects to the Main Distribution Frame (MDF) for access to OSP cable pairs as shown in Figure 1.

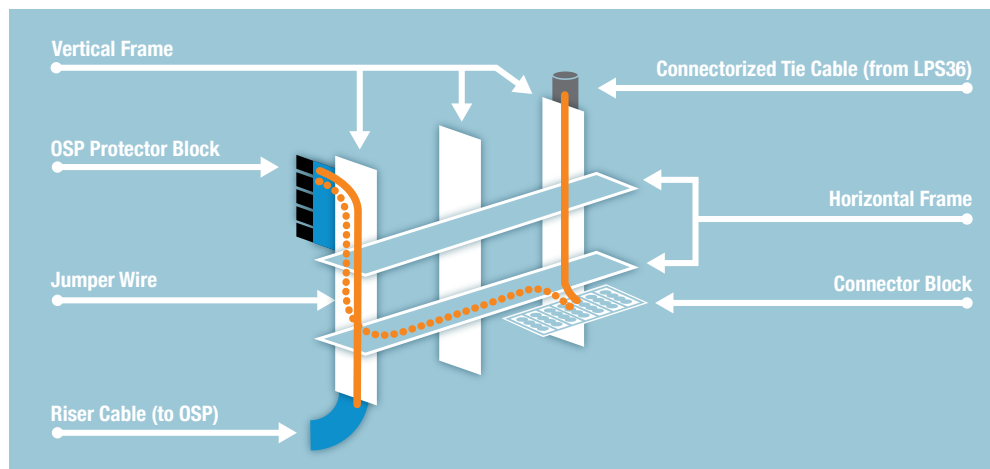

Figure 1: Connection to MDF

The outputs of Alpha's LPS36 Line Power shelves are connectorized using built-in female, 25-pair (50-pin) Amphenol connectors located on the left side of the shelf as shown in Figure 2. The J1 connector provides access to the outputs of the Up-converter modules on the left side of the shelf; the J2 connector provides access to the modules on the right side of the shelf.

Each 23-inch LPS36 shelf accommodates up to twelve (12) Quad Up-converter Modules for a total output capacity of forty-eight (48) circuits. Each Amphenol connector (J1 and J2) has twenty-four (24) of the available twenty-five (25) pairs wired, with the 25th pair left vacant or spare. Each 19-inch LPS36 shelf accommodates nine (9) Quad Up-converter Modules for a total output capacity of thirty-six (36) circuits. Since the 19-inch shelf has fewer circuits, there are more spare pairs in the Amphenol connectors (J1 and J2). With the 19-inch shelf, eighteen (18) of the available twenty-five (25) pairs are used in each connector, with the remaining seven (7) pairs left vacant or spare.

The Line Power equipment connects to the Main Distribution Frame (MDF) via 25-pair cables that are connectorized on both ends. One end terminates on the Up-converter shelf while the other end plugs onto the underside of a connector block located on the horizontal side of the MDF. The Line Power circuits do not electrically interfere with POTS and DSL circuits, so they can be intermingled on the block and frame. However, a best practice is to dedicate a block on the horizontal side of the frame that segregates the Line Power circuits to help prevent accidental contact with the elevated voltage.

To connect to OSP cables, jumper wires are run from the horizontal block to a protector block on the vertical side of the MDF. The block on the vertical side is hardwired to the OSP cables via riser cables. Because of the Line Power voltage, the best practice is to use high voltage (300Vdc) protectors that are a different color (e.g., red) than the conventional black protectors. Another best practice to use a unique colored jumper wire for the connection between the horizontal and vertical sides so that technicians can recognize the presence of the Line Power voltage. Photographs showing identification techniques are provided in Figure 3.

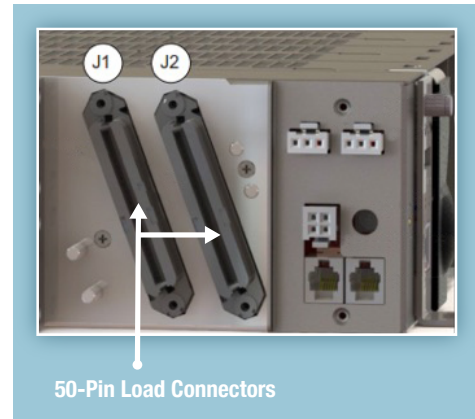

Figure 2: LPS Shelf Output Power Connections



Figure 3: Horizontal Connector with Precautionary Labels

Cabinet Applications

Line Power deployment in cabinets differ from CO applications in (1) the various types of Up-converter shelves or housings available, and (2) the method of accessing surge protectors and connecting to the OSP cables. Alpha offers three types of Line Power configurations for cabinet applications:

1. **LPS36 19-inch rack-mount shelf and 23-inch rack-mount shelf (same as the ones used in the CO applications)**
2. **LPS36 Compact Shelf, a low-profile shelf applique that accommodates up to four (4) Quad Up-converter Modules**
3. **LPS04, a standalone sealed Up-converter module with a fixed output of four (4) circuits.**

With both the rack-mount shelves and the LPS36 Compact Shelf, the outputs are typically routed to a surge protection block inside the cabinet. The protector block may be connectorized or hardwired. An example of a protector block is shown in Figure 4. As with the CO application, red cap protectors and specially colored jumper wires are recommended to alert technicians of the presence of Line Power.

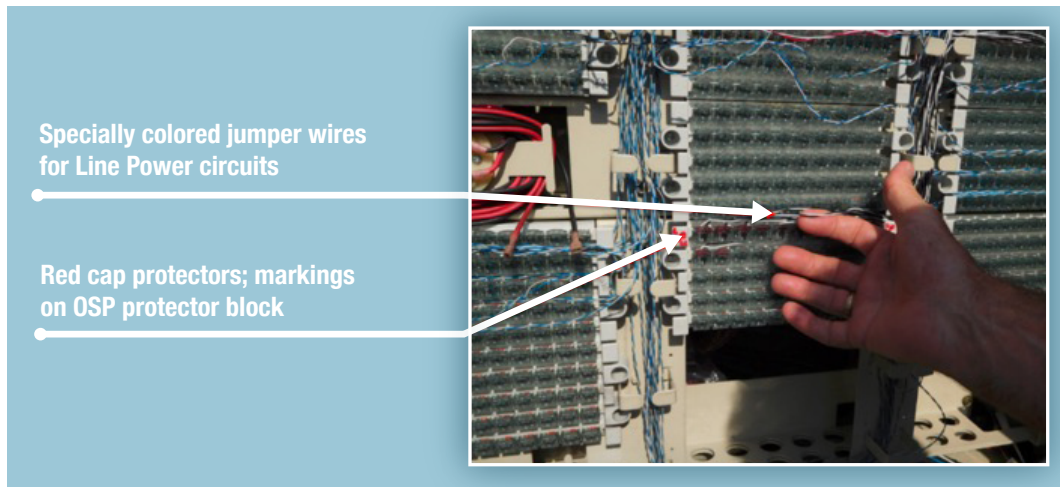

Figure 4: OSP Cabinet Connector Block



Figure 5: LPS36 Compact Shelf

The **LPS36 Compact Shelf**, shown in Figure 5, is often used in cabinet applications because it provides the right amount of capacity while consuming minimal space inside the cabinet. This shelf is equipped with a 10-foot long pigtail cable terminated in an Amphenol 25-pair connector. Only thirty-two (32) of the fifty (50) pins are utilized, with the remaining eighteen (18) pins left empty or spare.

While the LPS36 Compact and the rack-mount shelves are modular and equipped with connectorized cables for connection to the Outside Plant, the **LPS04 Sealed Up-converter Module** is a single Up-converter module enclosed in a sealed housing for connection to four (4) OSP cable pairs. It is often retrofitted to an existing OSP enclosure (such as a digital loop carrier or DSLAM cabinet) for powering one or two downstream DSLAMs at the far edge of the network. The unit may be installed inside the cabinet, attached to the outside of the cabinet, or mounted on a pole or nearby OSP splice facility. As such, this unit is equipped with a 6-foot long, 12-conductor, #24 AWG stub cable for connecting to the OSP cables. A block diagram of a typical LPS04 application is provided in Figure 6.

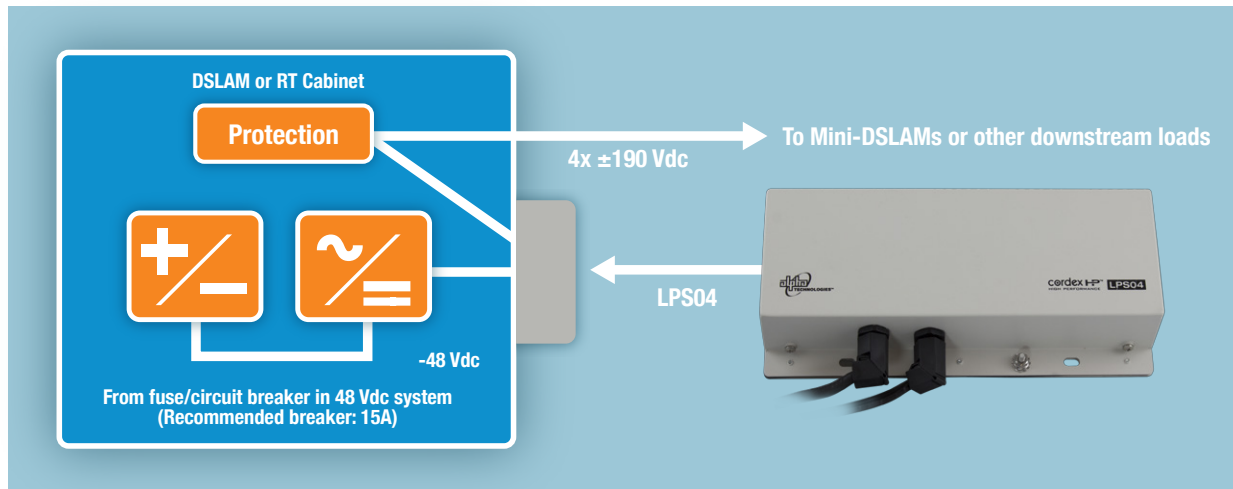

Figure 6: Block Diagram of Typical Sealed Up-converter Application

OSP SPLICE CONNECTIONS

The physical connections at splice points for Line Power are the same as with other services. The cable pairs can be connected using modular connectors (e.g., 3M's MS2™ connector) or discrete connectors (e.g., 3M's Scotchlok™ connectors). In either case, designating the cable pairs in the pedestal or splice case is a best practice to alert technicians of the presence of Line Power. This may be done by adding a label inside the facility and/or tagging the binder group or cable pairs. A label or a specially colored ribbon can suffice for labeling the binder group or pair carrying the Line Power service. An example of a pedestal marked for Line Power circuits is shown in Figure 7. Ideally, any connection and splice points along a Line Power route should also be identified, though it may not be practical to visit splice points that are not directly involved in the Line Power circuit provisioning.

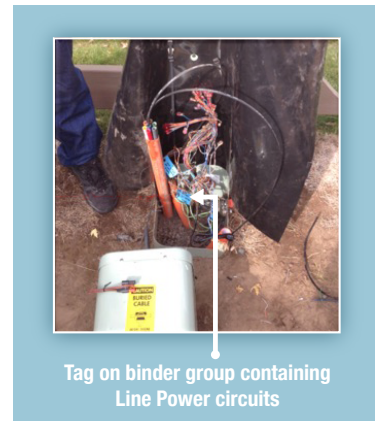

Figure 7: OSP Connections at the DSLAM



Figure 8: OSP Connections at the DSLAM

CONNECTING THE DSLAM

Most DSLAMs include a place to terminate the OSP pairs used for power. The photo in Figure 7 shows a terminal strip for connecting the power pairs along with a protector field for installing high capacity gas tube protectors for each circuit. The power pairs connect to the DSLAM using screw terminals. Normal OSP procedures apply when preparing the cable, connecting it to the chassis, stripping the conductors on the cable pairs, and making the final terminations. In the event the pairs are accidentally reversed, most DSLAMs provide protection so that the device is not damaged; instead, the DSLAM will simply not work until the reversal is corrected. A typical installation is shown in Figure 8.

CONNECTING BONDED CABLE PAIRS

As we learned in Chapter 3, paralleling or **bonding cable pairs** is a technique that can increase the reach of the Line Power circuit by reducing the total resistance in the cable. A block diagram showing the bonding of two pairs is provided in Figure 9.

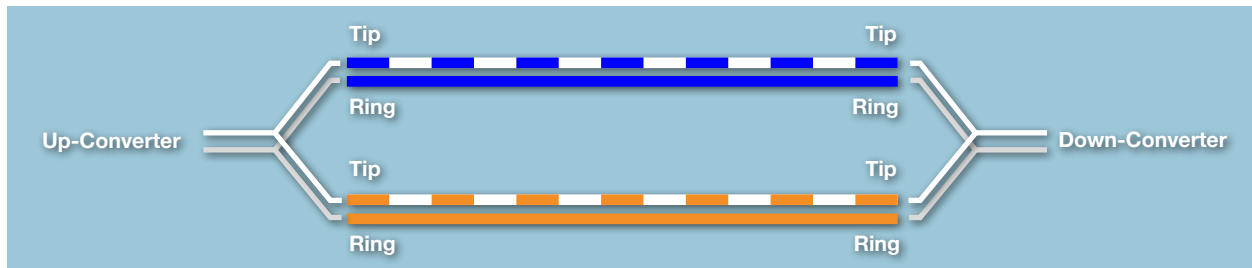

Figure 9: Paralleling Cable Pairs

At the CO, the cable pairs can be joined together on the Horizontal side of the MDF. A single position on the block can be jumpered to two different positions on the Vertical side of the frame. This approach provides a single input that connects to two different cable pairs.

At the remote end, the same two pairs must be connected in order to complete the circuit. If a binding post is provided in the pedestal or splice case, the connection can be made similar to the approach used in the CO on the MDF. More frequently, Scotchlocks are used to join two cable pairs to a single output cable that in turn connects to the DSLAM.



Figure 10

There is a special connector block, called a **bunching block**, that is designed to connect multiple cable terminations to a single feeder cable pair. The bunching block can be used at either the CO or in the OSP. A typical bunching block is shown in Figure 10.

SUMMARY

Like other circuits in the Outside Plant, Line Power circuits require end-to-end connectivity to ensure proper operation. The techniques for connecting Line Power are similar to other OSP circuits; connections at the CO, cabinet, and/or DSLAM do not require special skills or tools. Unlike many other circuits, however, the Line Power circuits are DC-only circuits and thus do not interfere with other circuits such as POTS, DSL, T1, or HDSL.

There is no electrical reason to segregate the Line Power circuits, though many service providers choose to provide an additional level of safety for technicians. Isolating the Line Power pairs minimizes concerns with both Inside Plant and Outside Plant personnel. When actual segregation is not practical, some service providers simply tag or mark the circuits to alert technicians of the presence of Line Power. There are several methods for marking and identifying the pairs to ensure the technicians are aware of the presence of Line Power voltages. When possible, the service provider should follow the best practices noted in this document to ensure safe, smooth and effective deployment of Line Power circuits.

In Chapter 7, we discuss how to install the Line Power equipment used in a DSLAM network. As the pioneer and foremost expert on Line Power, Alpha Technologies has created an 8-part series on how to plan and engineer a line-powered DSLAM network. The outline for the entire series is provided below:

The eight chapters planned for this White Paper series include:

- Chapter 1 Introduction to Line Powered DSLAMs**
- Chapter 2 Planning Considerations for Line Powered DSLAMs**
- Chapter 3 Determining the Reach for Line Powered DSLAM Networks**
- Chapter 4 Qualifying Cable Pairs for Line Powered DSLAM Networks**
- Chapter 5 Engineering the 48Vdc Plant to Power the Line Powered Equipment**
- Chapter 6 Engineering the OSP Connections in a Line Powered DSLAM Network**
- Chapter 7 Installing the Line Power Equipment**
- Chapter 8 Commissioning the Line Power Equipment**

Alpha Technologies Ltd.

Canada: Burnaby, British Columbia • T: 604 436 5900 • F: 604 436 1233

United States: Bellingham, Washington • T: 360 647 2360 • F: 360 671 4936

Alpha Technologies reserves the right to make changes to the products and information contained in this document without notice.
Copyright © 2017 Alpha Technologies. All Rights Reserved. Alpha® is a registered trademark of Alpha Technologies.
member of The Alpha Group™ is a trademark of Alpha Technologies.

For more information visit www.alpha.ca

Rev A (02/2017)

member of The  Group™



The Power of Loop Reduction: Planning, Engineering, & Commissioning Line Powered DSLAM Networks

Chapter 7: Installing the Line Power Equipment

An Alpha Technologies White Paper

by Kevin Borders
Vice President of Marketing

April 2017

Your Power Solutions Partner

INSTALLING LINE POWER EQUIPMENT IN THE CENTRAL OFFICE

Leveraging our experience with service provider Connect America Fund (CAF) projects, Alpha Technologies has created a comprehensive series of White Papers to outline how to use Line Power in a Loop Reduction program. This chapter (#7 in our 8-chapter series) focuses on how to install the Line Power equipment.

The Line Power Up-converter equipment can be installed in the Central Office or at an Outside Plant site. Though the mounting arrangements may differ per application, the electrical connections – grounding the shelf, securing the input and output power connections, and setting up the alarms – are similar. This chapter describes the installation process for installing the Up-converter equipment in both CO racks and OSP cabinets.

A Line Power Up-converter Shelf mounts in either a 19-inch or 23-inch relay rack. In CAF applications serving rural communities, one or two shelves will usually supply all the capacity needed to power the DSLAMs located throughout the exchange. The 2RU tall up-converter shelves are mid-mount designs, meaning the shelf extends 5 inches in front of the rack. The shelves are fastened to the racks using thread forming screws with paint piercing washers (two sets for each side of the shelf).

When more than one shelf is installed at a single location, each shelf must have a unique identifier so the controller can distinguish one from another. This is accomplished by setting a rotary dial switch on the left side of the shelf. Each shelf at the site should be assigned a unique number. The location of the rotary switch is shown in Figure 1. Note that it may be easier to set the switch prior to mounting the shelf in the rack.

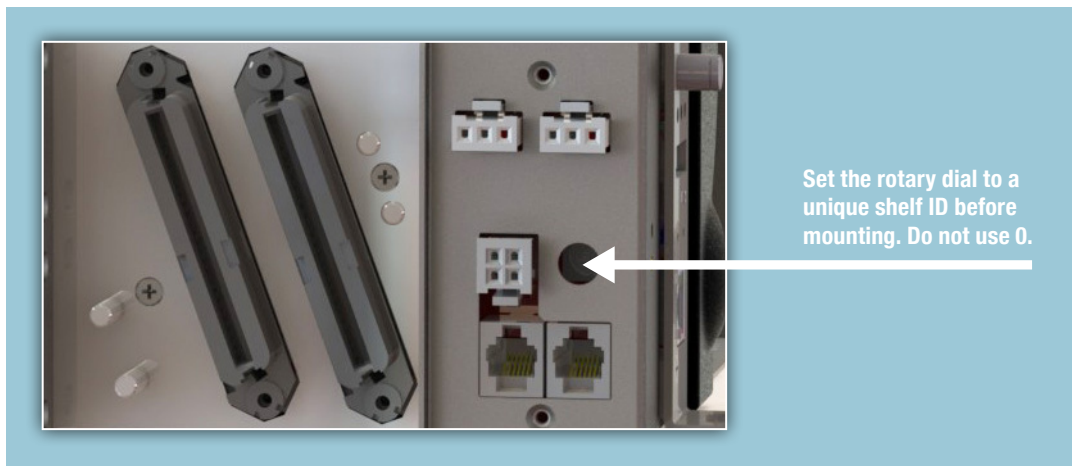

Figure 1 Shelf Identification Rotary Switch

After the shelf is mounted and the identification switch is set, the rest of the installation focuses on electrical connections, which include:

- Grounding the shelf
- Connecting 48Vdc input power
- Connecting the outputs to the OSP cables
- Connecting alarms

Grounding the shelf: Each shelf has three (3) sets of Ground studs for user convenience. One pair appears at the rear of the shelf, the other two on the left side of the shelf near the Amphenol output connectors. The positions are shown in Figure 2.

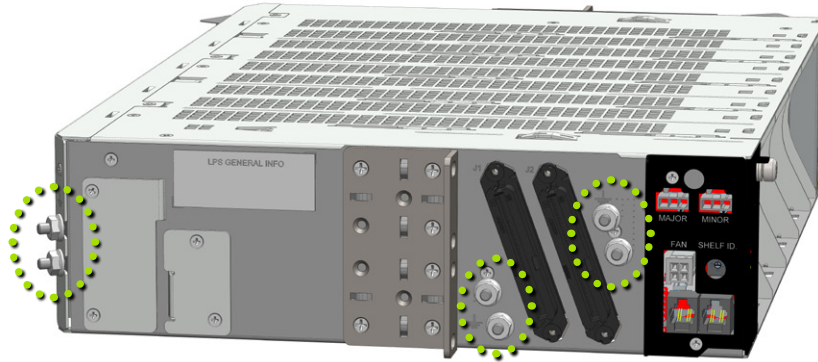

Figure 2 Ground Connections for LPS36 Shelf

The power system chassis is connected to the building master ground bus (MGB) to provide for personnel safety and to meet many telco-grounding requirements. The ground cable must be a minimum #6 AWG (16mm) copper wire and use standard 2-hole crimp lugs for 1/4" studs on 5/8" centers.

Input 48Vdc Power: Each shelf has two places to connect the 48Vdc input cables – one on the right front side of the shelf in front of the mounting rack and one on the right rear of the shelf. The two connection areas are bussed together, so either position is acceptable based on the application. When there are multiple LPS36 shelves deployed in a CO application, it is usually preferable to use the rear connections to avoid cable congestion in front of the rail in the relay rack. See Figure 3 for a diagram of the connection positions.

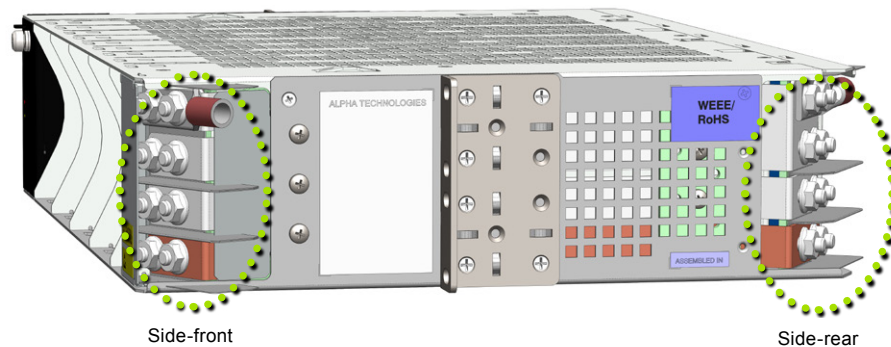

Figure 3 LPS36 Input 48Vdc Connections

Both the front and rear input voltage positions have four (4) connections – two for Return, one for the A side of the shelf and one for the B side of the shelf. As noted in Chapter 5, the A feed powers the modules on the left side of the shelf (slots 1-6 for the 23" shelf, slots 1-5 for the 19" shelf) and the B feed powers the modules on the right side of the shelf (slots 7-12 for the 23" shelf, slots 6-9 for the 19" shelf). Each connection accepts a two-hole lug and is designed for 1/4" holes on 5/8" centers. See Figure 4 for a close-up view of the connections.

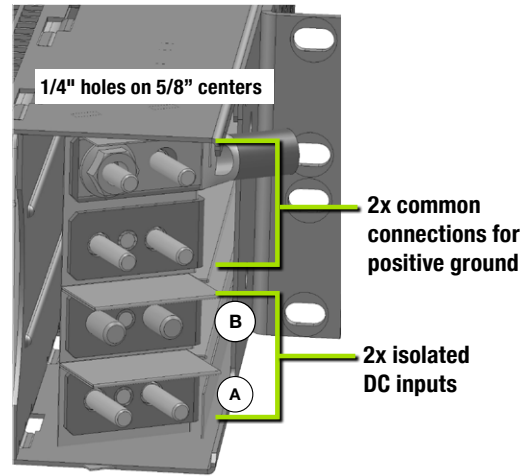

Figure 4 LPS36 A/B Input Power Connections

Output ±190Vdc Power: Both the 19-inch and 23-inch shelves are equipped with two female Amphenol connectors located on the left side of the shelf. The connectors are hard-wired to the outputs of the modules in the card slots. The mating male connector is the Tyco 5229912. See Figure 5 for a photo of the connectors.

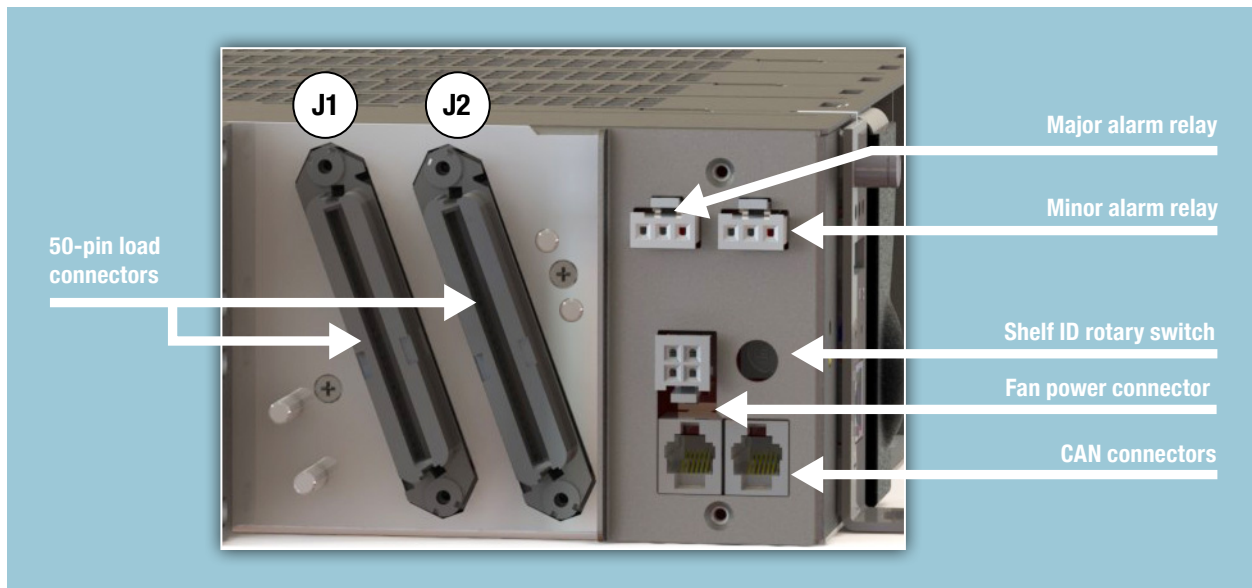

Figure 5 LPS36 Output Cable Connections

The 23-inch LPS36 shelf houses up to 12 Quad Up-converter Modules for a total output capacity of 48 circuits. Each Amphenol connector (J1 and J2) has 24 of the available 25 pairs wired, with the 25th pair left vacant or spare. For the 23-inch shelf, the pin-outs for these connectors along with the color code designation for the cables are provided in Table 1.

LPS36 23-INCH SHELF PIN-OUTS															
CONNECTOR J1 Pin-Outs, 23" Shelf								CONNECTOR J2 Pin-Outs, 23" Shelf							
PIN POS	Tip/ Ring	Color	Shelf OUT	PIN POS	Tip/ Ring	Color	23" Shelf OUT	PIN POS	Tip/ Ring	Color	Shelf OUT	PIN POS	Tip/ Ring	Color	23" Shelf OUT
1	Tip	White	Conv1_Ch1-	26	Ring	Blue	Conv1_Ch1+	1	Tip	White	Conv7_Ch1-	26	Ring	Blue	Conv7_Ch1+
2	Tip	White	Conv1_Ch2-	27	Ring	Orange	Conv1_Ch2+	2	Tip	White	Conv7_Ch2-	27	Ring	Orange	Conv7_Ch2+
3	Tip	White	Conv1_Ch3-	28	Ring	Green	Conv1_Ch3+	3	Tip	White	Conv7_Ch3-	28	Ring	Green	Conv7_Ch3+
4	Tip	White	Conv1_Ch4-	29	Ring	Brown	Conv1_Ch4+	4	Tip	White	Conv7_Ch4-	29	Ring	Brown	Conv7_Ch4+
5	Tip	White	Conv2_Ch1-	30	Ring	Slate	Conv2_Ch1+	5	Tip	White	Conv8_Ch1-	30	Ring	Slate	Conv8_Ch1+
6	Tip	Red	Conv2_Ch2-	31	Ring	Blue	Conv2_Ch2+	6	Tip	Red	Conv8_Ch2-	31	Ring	Blue	Conv8_Ch2+
7	Tip	Red	Conv2_Ch3-	32	Ring	Orange	Conv2_Ch3+	7	Tip	Red	Conv8_Ch3-	32	Ring	Orange	Conv8_Ch3+
8	Tip	Red	Conv2_Ch4-	33	Ring	Green	Conv2_Ch4+	8	Tip	Red	Conv8_Ch4-	33	Ring	Green	Conv8_Ch4+
9	Tip	Red	Conv3_Ch1-	34	Ring	Brown	Conv3_Ch1+	9	Tip	Red	Conv9_Ch1-	34	Ring	Brown	Conv9_Ch1+
10	Tip	Red	Conv3_Ch2-	35	Ring	Slate	Conv3_Ch2+	10	Tip	Red	Conv9_Ch2-	35	Ring	Slate	Conv9_Ch2+
11	Tip	Black	Conv3_Ch3-	36	Ring	Blue	Conv3_Ch3+	11	Tip	Black	Conv9_Ch3-	36	Ring	Blue	Conv9_Ch3+
12	Tip	Black	Conv3_Ch4-	37	Ring	Orange	Conv3_Ch4+	12	Tip	Black	Conv9_Ch4-	37	Ring	Orange	Conv9_Ch4+
13	Tip	Black	Conv4_Ch1-	38	Ring	Green	Conv4_Ch1+	13	Tip	Black	Conv10_Ch1-	38	Ring	Green	Conv10_Ch1+
14	Tip	Black	Conv4_Ch2-	39	Ring	Brown	Conv4_Ch2+	14	Tip	Black	Conv10_Ch2-	39	Ring	Brown	Conv10_Ch2+
15	Tip	Black	Conv4_Ch3-	40	Ring	Slate	Conv4_Ch3+	15	Tip	Black	Conv10_Ch3-	40	Ring	Slate	Conv10_Ch3+
16	Tip	Yellow	Conv4_Ch4-	41	Ring	Blue	Conv4_Ch4+	16	Tip	Yellow	Conv10_Ch4-	41	Ring	Blue	Conv10_Ch4+
17	Tip	Yellow	Conv5_Ch1-	42	Ring	Orange	Conv5_Ch1+	17	Tip	Yellow	Conv11_Ch1-	42	Ring	Orange	Conv11_Ch1+
18	Tip	Yellow	Conv5_Ch2-	43	Ring	Green	Conv5_Ch2+	18	Tip	Yellow	Conv11_Ch2-	43	Ring	Green	Conv11_Ch2+
19	Tip	Yellow	Conv5_Ch3-	44	Ring	Brown	Conv5_Ch3+	19	Tip	Yellow	Conv11_Ch3-	44	Ring	Brown	Conv11_Ch3+
20	Tip	Yellow	Conv5_Ch4-	45	Ring	Slate	Conv5_Ch4+	20	Tip	Yellow	Conv11_Ch4-	45	Ring	Slate	Conv11_Ch4+
21	Tip	Violet	Conv6_Ch2-	46	Ring	Blue	Conv6_Ch2+	21	Tip	Violet	Conv12_Ch1-	46	Ring	Blue	Conv12_Ch1+
22	Tip	Violet	Conv6_Ch3-	47	Ring	Orange	Conv6_Ch3+	22	Tip	Violet	Conv12_Ch2-	47	Ring	Orange	Conv12_Ch2+
23	Tip	Violet	Conv6_Ch4-	48	Ring	Green	Conv6_Ch4+	23	Tip	Violet	Conv12_Ch3-	48	Ring	Green	Conv12_Ch3+
24	Tip	Violet	Conv6_Ch1-	49	Ring	Brown	Conv6_Ch1+	24	Tip	Violet	Conv12_Ch4-	49	Ring	Brown	Conv12_Ch4+
25	Tip	Violet	Not Used	50	Ring	Slate	Not Used	25	Tip	Violet	Not Used	50	Ring	Slate	Not Used

Table 1 LPS36 23-Inch Shelf Output Pin-outs

The 19-inch LPS36 shelf houses up to nine (9) Quad Up-converter Modules for a total output capacity of 36 circuits. The smaller capacity results in more spare pairs in the Amphenol connectors (J1 and J2). In the 19-inch shelf, 18 of the available 25 pairs are used in each connector, with the remaining 7 pairs left vacant or spare. For the 19-inch shelf, the pin-outs for the connectors along with the color code designation for the cables are provided in Table 2.

LPS36 19-INCH SHELF PIN-OUTS															
CONNECTOR J1 Pin-Outs, 19" Shelf								CONNECTOR J2 Pin-Outs, 19" Shelf							
PIN POS	Tip/Ring	Color	19" Shelf OUT	PIN POS	Tip/Ring	Color	19" Shelf OUT	PIN POS	Tip/Ring	Color	19" Shelf OUT	PIN POS	Tip/Ring	Color	19" Shelf OUT
1	Tip	White	Conv1_Ch1-	26	Ring	Blue	Conv1_Ch1+	1	Tip	White	Conv6_Ch1-	26	Ring	Blue	Conv6_Ch1+
2	Tip	White	Conv1_Ch2-	27	Ring	Orange	Conv1_Ch2+	2	Tip	White	Conv6_Ch2-	27	Ring	Orange	Conv6_Ch2+
3	Tip	White	Conv1_Ch3-	28	Ring	Green	Conv1_Ch3+	3	Tip	White	Conv6_Ch3-	28	Ring	Green	Conv6_Ch3+
4	Tip	White	Conv1_Ch4-	29	Ring	Brown	Conv1_Ch4+	4	Tip	White	Conv6_Ch4-	29	Ring	Brown	Conv6_Ch4+
5	Tip	White	Conv2_Ch1-	30	Ring	Slate	Conv2_Ch1+	5	Tip	White	Conv7_Ch1-	30	Ring	Slate	Conv7_Ch1+
6	Tip	Red	Conv2_Ch2-	31	Ring	Blue	Conv2_Ch2+	6	Tip	Red	Conv7_Ch2-	31	Ring	Blue	Conv7_Ch2+
7	Tip	Red	Conv2_Ch3-	32	Ring	Orange	Conv2_Ch3+	7	Tip	Red	Conv7_Ch3-	32	Ring	Orange	Conv7_Ch3+
8	Tip	Red	Conv2_Ch4-	33	Ring	Green	Conv2_Ch4+	8	Tip	Red	Conv7_Ch4-	33	Ring	Green	Conv7_Ch4+
9	Tip	Red	Conv3_Ch1-	34	Ring	Brown	Conv3_Ch1+	9	Tip	Red	Conv8_Ch1-	34	Ring	Brown	Conv8_Ch1+
10	Tip	Red	Conv3_Ch2-	35	Ring	Slate	Conv3_Ch2+	10	Tip	Red	Conv8_Ch2-	35	Ring	Slate	Conv8_Ch2+
11	Tip	Black	Conv3_Ch3-	36	Ring	Blue	Conv3_Ch3+	11	Tip	Black	Conv8_Ch3-	36	Ring	Blue	Conv8_Ch3+
12	Tip	Black	Conv3_Ch4-	37	Ring	Orange	Conv3_Ch4+	12	Tip	Black	Conv8_Ch4-	37	Ring	Orange	Conv8_Ch4+
13	Tip	Black	Conv4_Ch1-	38	Ring	Green	Conv4_Ch1+	13	Tip	Black	Conv9_Ch1-	38	Ring	Green	Conv9_Ch1+
14	Tip	Black	Conv4_Ch2-	39	Ring	Brown	Conv4_Ch2+	14	Tip	Black	Conv9_Ch2-	39	Ring	Brown	Conv9_Ch2+
15	Tip	Black	Conv4_Ch3-	40	Ring	Slate	Conv4_Ch3+	15	Tip	Black	Conv9_Ch3-	40	Ring	Slate	Conv9_Ch3+
16	Tip	Yellow	Conv4_Ch4-	41	Ring	Blue	Conv4_Ch4+	16	Tip	Yellow	Conv9_Ch4-	41	Ring	Blue	Conv9_Ch4+
17	Tip	Yellow	Conv5_Ch1-	42	Ring	Orange	Conv5_Ch1+	17	Tip	Yellow	Not Used	42	Ring	Orange	Not Used
18	Tip	Yellow	Conv5_Ch2-	43	Ring	Green	Conv5_Ch2+	18	Tip	Yellow	Not Used	43	Ring	Green	Not Used
19	Tip	Yellow	Conv5_Ch3-	44	Ring	Brown	Conv5_Ch3+	19	Tip	Yellow	Not Used	44	Ring	Brown	Not Used
20	Tip	Yellow	Conv5_Ch1-	45	Ring	Slate	Conv5_Ch1+	20	Tip	Yellow	Not Used	45	Ring	Slate	Not Used
21	Tip	Violet	Not Used	46	Ring	Blue	Not Used	21	Tip	Violet	Not Used	46	Ring	Blue	Not Used
22	Tip	Violet	Not Used	47	Ring	Orange	Not Used	22	Tip	Violet	Not Used	47	Ring	Orange	Not Used
23	Tip	Violet	Not Used	48	Ring	Green	Not Used	23	Tip	Violet	Not Used	48	Ring	Green	Not Used
24	Tip	Violet	Not Used	49	Ring	Brown	Not Used	24	Tip	Violet	Not Used	49	Ring	Brown	Not Used
25	Tip	Violet	Not Used	50	Ring	Slate	Not Used	25	Tip	Violet	Not Used	50	Ring	Slate	Not Used

Table 2 LPS36 19-Inch Shelf Output Pin-outs

Alarm Connections: Alarm and status indicators are provided on the controller and on each Quad Up-converter Module. The alarms are also reported via SNMP and the controller for access locally or remotely. For hardwired alarms, each LPS36 shelf is equipped with two sets of Form C relay contacts – one for Major alarms and one for Minor alarms. The alarms can be wired for Normally Open (NO) or Normally Closed (NC) configuration. The relays can be connected to the local alarm-sending unit using wire gauges from #28 AWG to #16 AWG. In addition, outputs from the alarm relays can be ganged to produce one alarm at the alarm-sending unit. The relay connections are provided on the left side of the shelf as shown in Figure 6.

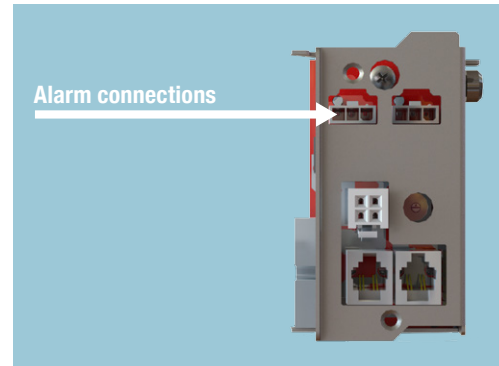

Figure 6 LPS36 Alarm Relay Connections

INSTALLING THE LINE POWER EQUIPMENT IN A CABINET

The 23-inch and 19-inch Line Power Up-converter Shelves generally provide more capacity than needed in typical cabinet applications. For that reason, Alpha offers two smaller up-converter packages. The LPS36 Compact Shelf provides up to 16 Line Power channels in a compact 2RUx6"x12" form factor. It accommodates up to four (4) Line Power Quad-converter modules, the same ones used in the CO applications. The LPS04 Sealed Quad Up-converter Module is an even smaller package. This device is a sealed OSP housing that contains one Quad Up-converter module in a potted, metal enclosure. The connections for each of these devices are discussed below.

LPS36 COMPACT SHELF

This shelf is particularly suitable for remote OSP power cabinets where free rack space is tight or non-existent. With a six-inch width and a single side bracket, it can be easily mounted to the side of a rack support post without using up valuable rack space. Often, this shelf is pre-packaged in a cabinet from either the OEM vendor or from Alpha. If an existing DSLAM cabinet or Remote Terminal cabinet is being retrofitted for the LPS36 Compact Shelf, the configuration may require the use of the optional fan tray which mounts directly below the shelf. For detailed information on this product configuration, consult Alpha Technologies' Cordex HP LPS36 Compact Installation Manual (Part # 0300189-J1).

The LPS36 Compact Shelf comes with a bracket to mount the LPS36 Compact shelf to a structural component- typically one side of an equipment rack or a frame inside an outside plant enclosure. The bracket can be assembled to the left or right side of the shelf depending on the installation. When a fan tray is used, the shelf can be in any orientation depending on the space available. Note that when a fan tray is not used, the shelf can only be oriented in normal, upright position. The shelf is fastened to the racks using thread forming screws with paint piercing washers. See Figure 7 for diagrams of the bracket installation and a left-side rack mount.

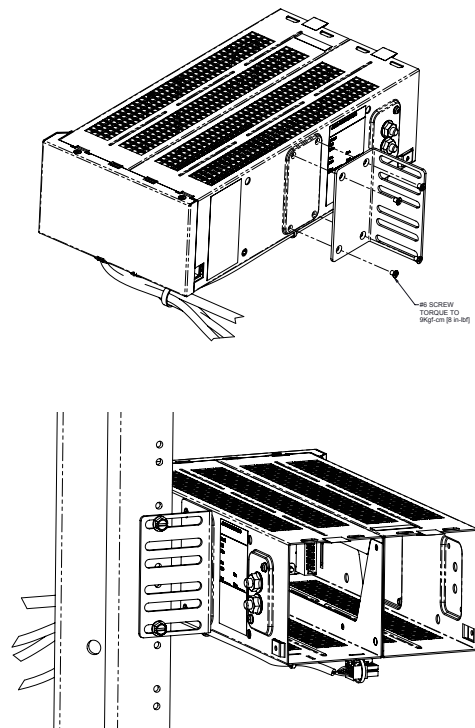

Figure 7 LPS36 Compact Mounting Examples

Grounding: Protective ground terminals are provided for chassis ground at the left front side of LPS36 Compact as shown in Figure 8. The power system chassis is connected to the master ground bus (MGB). This connection is necessary for personnel safety and to meet many telco-grounding requirements. Minimum #6 AWG (16mm) copper wire is required along with standard 2-hole crimp lugs for 1/4" studs on 5/8" centers secured with 1/4-20 serrated flanged nuts (supplied) to provide the anti-rotation necessary for primary ground connections.

Input 48Vdc Power: Two #8 AWG cables with lugs are provided for input power connections. The 18-inch cables exit the rear of the shelf and are terminated in compression lugs. The HOT lead is Red, the RTN lead is Black. See Figure 9 for a diagram of the connection positions.

Output ±190Vdc Power: Figure 9 also shows the output connection, which is provided in the form of a 54-inch long cable equipped with a female Amphenol connector. This output cable also exits the rear of the shelf. The mating connector for these Amphenol connectors is the Tyco 5229912. The pin-outs for the connector along with the color code designation for the cables are provided in Table 3.

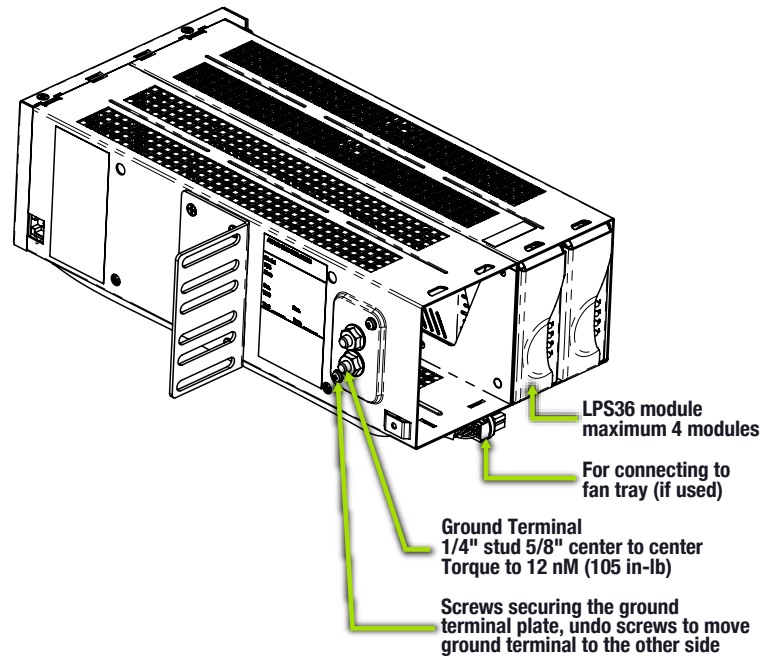

Figure 8 LPS36 Compact Ground Connections

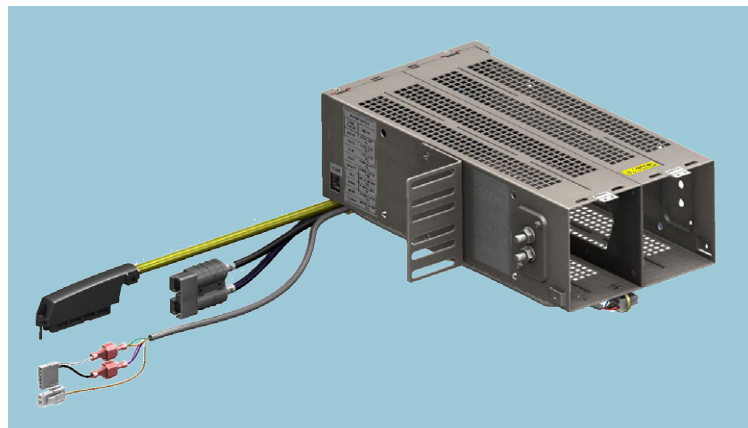

Figure 9 LPS36 Compact Input and Output Cables

LPS36 COMPACT SHELF PIN-OUTS							
CONNECTOR J1 Pin-Outs, LPS36 Compact Shelf							
PIN POS	Tip/ Ring	Color	23" Shelf OUT	PIN POS	Tip/ Ring	Color	23" Shelf OUT
1	Tip	White	Conv1_Ch1-	26	Ring	Blue	Conv1_Ch1+
2	Tip	White	Conv1_Ch2-	27	Ring	Orange	Conv1_Ch2+
3	Tip	White	Conv1_Ch3-	28	Ring	Green	Conv1_Ch3+
4	Tip	White	Conv1_Ch4-	29	Ring	Brown	Conv1_Ch4+
5	Tip	White	Conv2_Ch1-	30	Ring	Slate	Conv2_Ch1+
6	Tip	Red	Conv2_Ch2-	31	Ring	Blue	Conv2_Ch2+
7	Tip	Red	Conv2_Ch3-	32	Ring	Orange	Conv2_Ch3+
8	Tip	Red	Conv2_Ch4-	33	Ring	Green	Conv2_Ch4+
9	Tip	Red	Conv3_Ch1-	34	Ring	Brown	Conv3_Ch1+
10	Tip	Red	Conv3_Ch2-	35	Ring	Slate	Conv3_Ch2+
11	Tip	Black	Conv3_Ch3-	36	Ring	Blue	Conv3_Ch3+
12	Tip	Black	Conv3_Ch4-	37	Ring	Orange	Conv3_Ch4+
13	Tip	Black	Conv4_Ch1-	38	Ring	Green	Conv4_Ch1+
14	Tip	Black	Conv4_Ch2-	39	Ring	Brown	Conv4_Ch2+
15	Tip	Black	Conv4_Ch3-	40	Ring	Slate	Conv4_Ch3+
16	Tip	Yellow	Conv4_Ch4-	41	Ring	Blue	Conv4_Ch4+
17	Tip	Yellow	Not Used	42	Ring	Orange	Not Used
18	Tip	Yellow	Not Used	43	Ring	Green	Not Used
19	Tip	Yellow	Not Used	44	Ring	Brown	Not Used
20	Tip	Yellow	Not Used	45	Ring	Slate	Not Used
21	Tip	Violet	Not Used	46	Ring	Blue	Not Used
22	Tip	Violet	Not Used	47	Ring	Orange	Not Used
23	Tip	Violet	Not Used	48	Ring	Green	Not Used
24	Tip	Violet	Not Used	49	Ring	Brown	Not Used
25	Tip	Violet	Not Used	50	Ring	Slate	Not Used

Table 3 LPS36 19-Inch Shelf Output Pin-outs

Alarms: The LPS36 Compact has two Form C contacts available for Major and Minor alarms. A separate Form C contact is also provided for applications where a Fan Tray is used. The stub-ended output cable is shown in Figure 9. The assignments for the alarm cable are provide in Table 4.









LPS36 COMPACT ALARM DESIGNATIONS		
WIRE COLOR	SIGNAL	
	BROWN	FAN ALARM NC
	WHITE	FAN ALARM COM
	BLUE	FAN ALARM NO
	BLACK	MAJOR ALARM NC
	ORANGE	MAJOR ALARM COM
	RED	MAJOR ALARM NO
	VIOLET	MINOR ALARM NC
	GREEN	MINOR ALARM COM
	YELLOW	MINOR ALARM NO

Table 4 LPS36 Alarm Cable Designations

LPS04 SEALED QUAD UP-CONVERTER MODULE

The LPS04 is sealed so that it can be mounted either inside or outside an OSP cabinet or enclosure. The unit can be mounted vertically or horizontally as shown in Figure 10. In the same diagram, note that there are four oblong openings for fastening hardware. For mounting details, consult Alpha Technologies' Cordex HP LPS04 Installation and Operation Manual (Part # 0120037-J0).

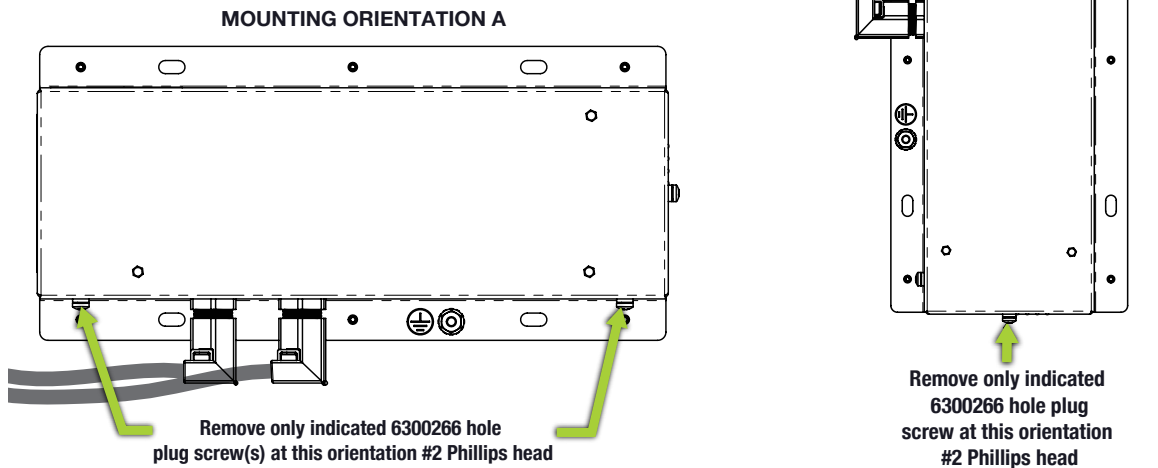

Figure 10 LPS04 Mounting Options

The LPS04 is equipped with input and output cables that facilitate connection to the existing 48Vdc power system, OSP cables, and Alarm connections. The input cable contains both the input voltage and return connections as well as the connection for chassis ground. The output cable includes both the OSP connections and the alarm connections. Refer to Figure 11 for a diagram and photograph of the cable connections.

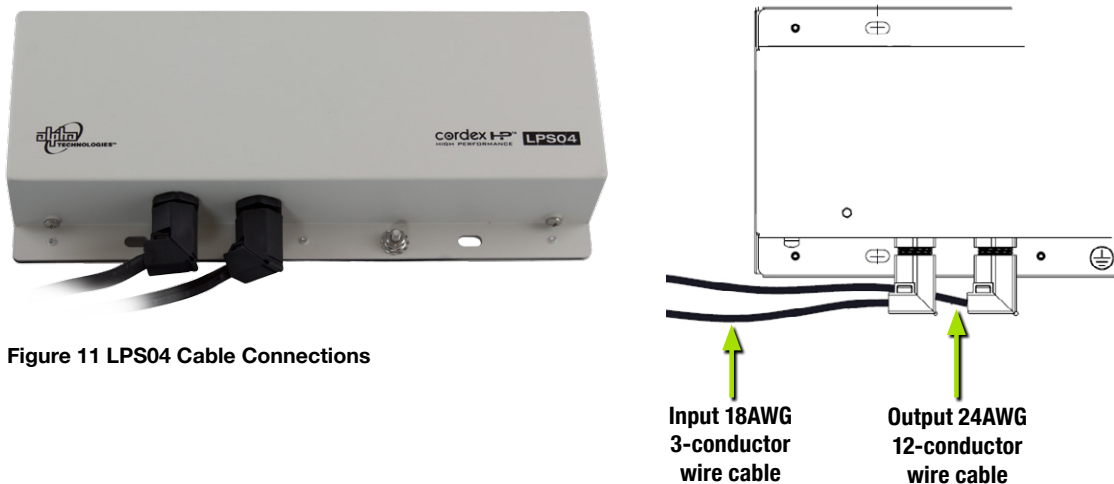

Figure 11 LPS04 Cable Connections

Input Cable: The input cable that includes both the 48Vdc and chassis ground connections is a 6-foot long blunt-end. The cable contains three each #12 AWG conductors, one for the -48Vdc input, one for Return, and one for chassis ground. The wiring diagram for the Input cable is provided in Table 5.

A #12 AWG ground wire included in the input cable is provided for connecting to chassis ground. An external ground connection is also available on the unit's housing. That connection is shown in Figure 12.

Output Cable: The output cable that connects to the OSP cables is a 6-foot long blunt-end cable that includes the four (4) OSP cables as well as Alarm cables. The cable is equipped with 12 each 24 AWG conductors. Form C contacts are available for connection to an alarm system. The wiring diagram for the output cable and the alarms is provided in Table 6 (note that the White/Gray cable is not used).

SUMMARY

Line Power Up-converters come in a variety of packages and sizes to suit particular applications. The mounting arrangements differ, but the electrical connections are generally similar. In each application, the shelf/unit must be properly grounded. Inputs from the 48Vdc rectifier plant provide power to the shelf. The outputs connect to OSP cables for routing to the DSLAM or other electronic devices. In each case, alarm connections are provided to ensure proper reporting of alarm conditions.

In Chapter 8, the final chapter in this series, we discuss how to commission the Line Power equipment used in a DSLAM network.

As the pioneer and foremost expert on Line Power, Alpha Technologies has created an 8-part series on how to plan and engineer a line-powered DSLAM network. The outline for the entire series is provided below:

The eight chapters for this White Paper series include:	
Chapter 1:	Introduction to Line Powered DSLAMs
Chapter 2:	Planning Considerations for Line Powered DSLAMs
Chapter 3:	Determining the Reach for Line Powered DSLAM Networks
Chapter 4:	Qualifying Cable Pairs for Line Powered DSLAM Networks
Chapter 5:	Engineering the 48Vdc Plant to Power the Line Powered Equipment
Chapter 6:	Engineering the OSP Connections in a Line Powered DSLAM Network
Chapter 7:	Installing the Line Power Equipment
Chapter 8:	Commissioning the Line Power Equipment

LPS04 INPUT CABLE DESIGNATIONS		
WIRE COLOR	CIRCUIT DESIGNATION	
WHITE	-48V	
BLACK	48V_RTN	
GREEN	CHASSIS GROUND	

Table 5 LPS04 Input Cable Designations

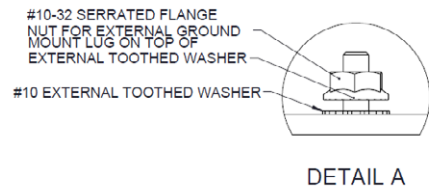

LPS04 OUTPUT CABLE DESIGNATIONS		
OUTPUT	WIRE COLOR	CIRCUIT DESIGNATION
OUTPUT 1	WHITE/BLUE	+190V_OUT1
	BLUE	-190V_OUT1
OUTPUT 2	WHITE/ORANGE	+190V_OUT2
	ORANGE	-190V_OUT2
OUTPUT 3	WHITE/GREEN	+190V_OUT3
	GREEN	-190V_OUT3
OUTPUT 4	WHITE/BROWN	+190V_OUT4
	BROWN	-190V_OUT4
ALARMS	BLUE/RED	Relay_NC
	RED	Relay_COM
	GRAY	Relay_NO
	WHITE/GRAY	---

Table 6 LPS04 Output Cable Designations



The Power of Loop Reduction: Planning, Engineering, & Commissioning Line Powered DSLAM Networks

Chapter 8: Commissioning the Line Power Equipment

An Alpha Technologies White Paper

by Kevin Borders
Vice President of Marketing

June 2017

Your Power Solutions Partner

COMMISSIONING THE LINE POWER EQUIPMENT

Leveraging our experience with service provider Connect America Fund (CAF) projects, Alpha Technologies has created a comprehensive series of White Papers that outline how to use Line Power in a Loop Reduction program. Our final chapter in our series, Chapter 8 focuses on how to commission the Line Power equipment in preparation for powering the DSLAMs.

At this stage, the Line Power shelf has been installed and wired to the 48Vdc source, the local alarm sender, Network Operations Center (NOC) if applicable, and the Main Distributing Frame (MDF). The cable pairs have been qualified for Line Power service, but are not yet connected to the DSLAM. The converter modules and controller are not yet installed, and the fuse or circuit breaker from the 48Vdc source of power is open so that there is no 48Vdc power at the shelf. This chapter will explain how to proceed to turn up the Line Power equipment and ensure power is available at the DSLAM.

TURNING UP THE LINE POWER UP-CONVERTER EQUIPMENT

Some Line Power shelves like Alpha's LPS36 19- and 23-inch rack-mount shelves include intelligent system controllers. Others, such as Alpha's LPS36 Compact Shelf and LPS04 Sealed Up-converter module do not. While power supply and delivery are the same in either case, there are additional steps when the controller is involved. We will cover them a little later in the paper.

- For modular shelves that include provision of a controller, such as Alpha's LPS36 19- and 23-inch rack-mount shelves, use the following procedure to energize the equipment:
Start with DC input breakers **off**
 1. Install the **CXCI+ Controller** in leftmost slot of the shelf (19-inch and 23-inch shelves only)
 2. Install the **LPS36 Up-converter Modules** in the slots
 3. Install blanks in the slots that are not to be equipped with converter modules
 4. Turn the DC input breakers **on**

- For modular shelves that do include a controller, such as Alpha's LPS36 Compact Shelf, use the following procedure to energize the equipment:
 1. Start with DC input breakers **off**
 2. Install the **LPS36 Up-converter Modules** in the slots
 3. Install blanks in the slots that are not to be equipped with converter modules
 4. Turn the DC input breakers **on**

- For the LPS04 Sealed Up-converter Module use the following procedure to energize the equipment:
 1. Start with DC input breakers **off**
 2. Turn the DC input breakers **on**

When any of the above procedures are completed, the channel LEDs on all the up-converter modules should be green. The Line Power equipment is energized and ready for connection to the DSLAM.

INITIALIZING THE CONTROLLER

The intelligent system controller offers increased functionality for Line Power equipment. Alpha's CXCI+ Controller used in the 19- and 23-inch shelves provides both local and remote access to the up-converter equipment. It includes an Ethernet port for local and remote communications. It also provides user-definable alarms as well as daily logging of power system events and system statistics.

In addition, the controller provides access to the Line Power modules and individual Line Power circuits so that they can be managed and controlled. This functionality includes viewing alarm conditions, voltage, and current levels for each circuit, as well as the ability to start up or shut down individual circuits. The latter feature is very useful in troubleshooting or during initial system turn-up.

The LPS36 19- and 23-inch shelves include a slot for Alpha's Cordex CXCI+ Controller on the far-left slot of the shelf. The controller is shown in Figure 1.

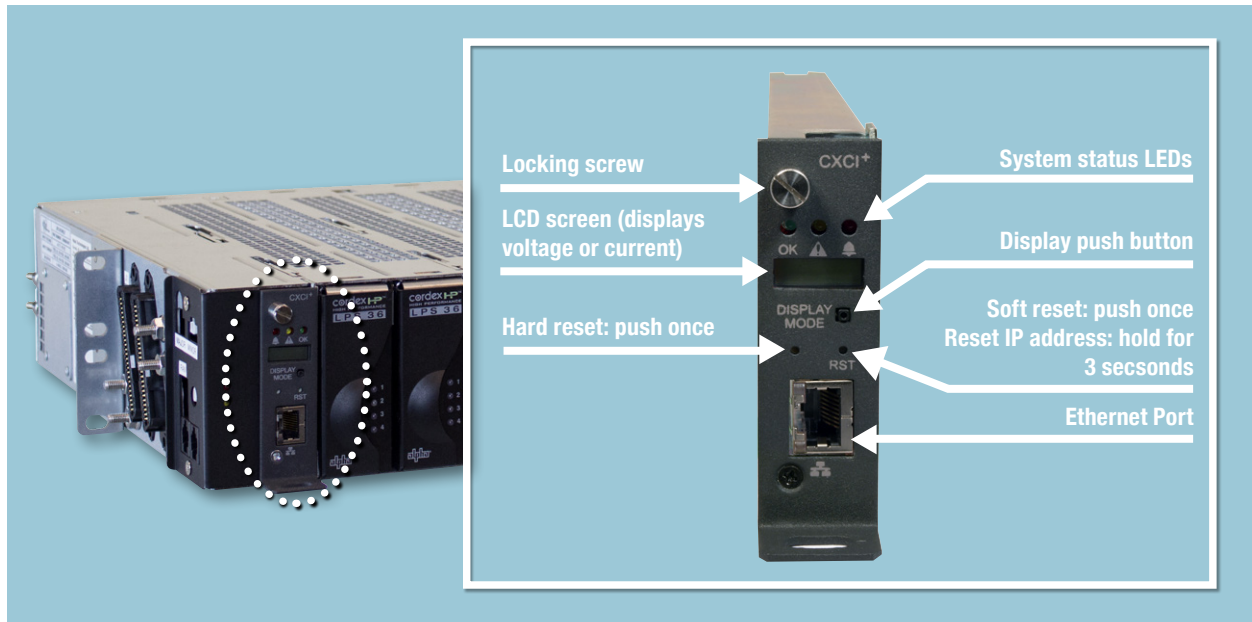

Figure 1 CXCI+ Controller

In loop reduction and CAF-II programs, a single shelf will often provide enough power for all the DSLAMs in the exchange. Nevertheless, there are occasions when multiple Line Power shelves are required at a single site. One CXCI+ Controller can control up to nine (9) nearby LPS36 shelves. When multiple shelves are installed, one of them is equipped with a controller. The rest are simply connected to the shelf with the Controller via a CAN bus jumper. The controller slot is left empty in those shelves. The CAN connections to the shelf and the daisy chain connections are shown in Figure 2.

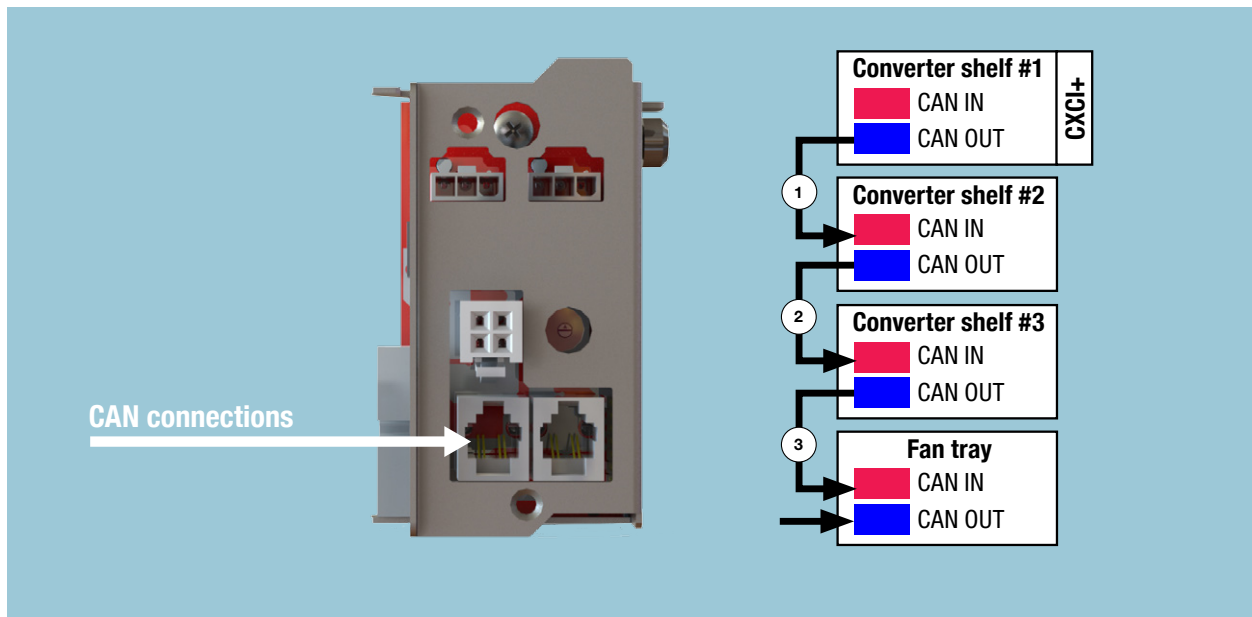

Figure 2 LPS36 CAN Connections

To initiate the CXCI+ Controller, ensure it is properly inserted, the locking screw is affixed, and power is connected to the system. Follow these steps to initialize the CXCI+ Controller:

1. Reset CXCI controller (front reset button) to set network IP parameters to factory default:
 - IP address: 10.10.10.201
 - Subnet mask: 255.255.255.0
2. Connect a laptop to the CXC controller with a network cable.
3. Laptop IP Network settings (**Start > Control Panel**)
 - IP address: 10.10.10.202
 - Subnet mask: 255.255.255.0
4. Turn off Pop-up Blocker
5. Type 10.10.10.201 in the web address bar (Alpha recommends Internet Explorer with compatibility view turned on)
6. Login to the CXC controller:
 - Username: Enter your company name and your initials
 - Password: 1234
7. Language selection: English
8. Set correct date and time (**Controller > Date & Time**).
9. Select **Line Powering System > View Live Status** to display a graphical view of all acquired LPS devices.

Clicking an LPS module displays a pop-up window with information specific to that LPS module and its channels.

NOTE: If red text displays saying, "Invalid Shelf IDs have been detected!" or "Duplicate Shelf IDs have been detected!" the rotary dials to set shelf IDs have not be set up correctly.
10. Resolve alarms: if any row/channel combination is highlighted, select **Alarms > View Live**
11. Status from the main menu to view LPS alarms.
12. Submit changes and **Accept**.
13. Log out.

MANAGING THE LPS36 COMPACT WITH A RECTIFIER SHELF CONTROLLER

Though the LPS36 Compact Shelf does not provide a slot for a controller, the converter modules can still be managed and controlled, provided the 48Vdc source is an Alpha rectifier plant equipped with a controller. There is a CAN port on the rear left side of the shelf as shown in Figure 3. A simple CAN connection from the rectifier to the LPS36 Compact provides control and management capabilities like those in the 19- and 23-inch shelves.

More information on how to operate the controller can be found in the CXCI+ system manual (0120011-J1) available at www.alpha.ca.

TESTING THE END-TO-END CIRCUIT

The Line Power circuits are now ready to be connected to the DSLAM. Prior to connecting the OSP cable pair(s) to the DSLAM, it is a best practice to ensure the circuit is not energized. This may be accomplished by (1) removing the Line Power module; (2) removing the protector at the MDF; or (3) using the controller to disable the channel(s).

Many DSLAMs offer screw terminals for direct connection of the OSP pairs such as those shown in Figure 4. For other connection arrangements, contact the DSLAM vendor.

Once the connection is completed at the DSLAM, the Line Power channel(s) can be energized (by reversing the steps in the preceding paragraph). The DSLAM should be equipped with an LED that turns on when power is present. The Line Power circuit is now turned up and ready for service.

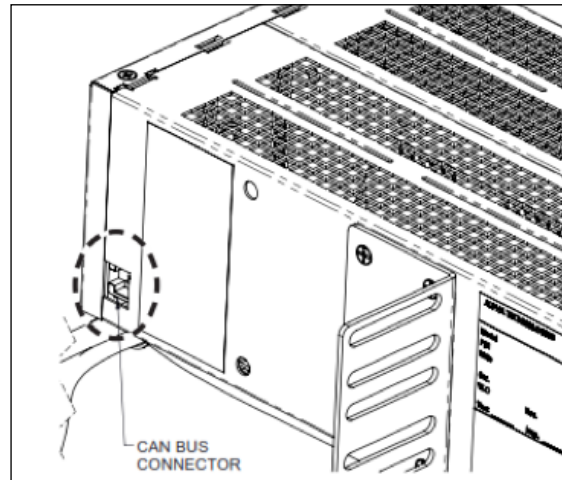

Figure 3 LPS36 Compact Shelf CAN Bus Connection



Figure 4 Typical DSLAM Terminal Strip

MANAGING DSLAMS REQUIRING MULTIPLE LINE POWERED CIRCUITS

Alpha's CXCI+ controller provides the user the ability to view all the channels associated with a DSLAM. This feature is particularly helpful since many DSLAMs require more than one Line Power circuit. This feature is set up by going to the **Line Powering System > Configure Groups** page, where groups can be added, removed, and renamed. If an additional channel is later required to power the DSLAM, it can be added to the group by clicking in the corresponding check box in the graphical view. An example of a 10-channel group is shown in the configure mode in Figure 5. In this example, all the first channel in LPS Module #5, the third channel in LPS Module #6, and the fourth channel in LPS Module #7 are included in Group #1.

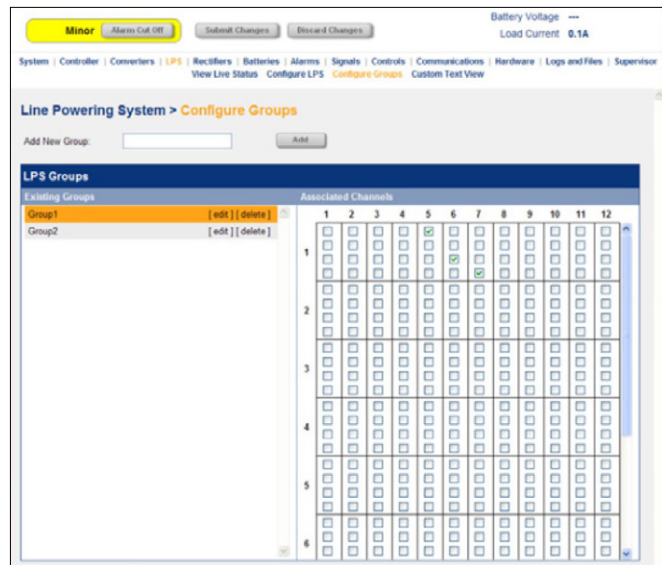

Figure 5 Grouping LPS Channels

SUMMARY

The turn-up and commissioning of the Line Power equipment is a relatively straightforward process. With all the connections in place, energizing the Line Power equipment amounts to installing the modules and/or controller, then turning on 48Vdc power to the shelf. The connections to the DSLAM can then be made and service verified. The addition of the controller requires additional steps in the turn-up procedure, but the result is a powerful tool that provides remote access, control, and management of the Line Power equipment down to the circuit, or channel, level.

As the pioneer and foremost expert on Line Power, Alpha Technologies created this 8-part series on The Power of Loop Reduction focusing on how to plan and engineer a line-powered DSLAM network. For more insight and answers to specific questions, contact Alpha Technologies at 800.667.8743.

The eight chapters of this White Paper series are:	
Chapter 1	Introduction to Line Powered DSLAMs
Chapter 2	Planning Considerations for Line Powered DSLAMs
Chapter 3	Determining the Reach for Line Powered DSLAM Networks
Chapter 4	Qualifying Cable Pairs for Line Powered DSLAM Networks
Chapter 5	Engineering the 48Vdc Plant to Power the Line Powered Equipment
Chapter 6	Engineering the OSP Connections in a Line Powered DSLAM Network
Chapter 7	Installing the Line Power Equipment
Chapter 8	Commissioning the Line Power Equipment

**About the Author**

Kevin Borders is the Vice President of Marketing at Alpha Technologies. He has over 30 years of experience in the Telecommunications and Power sectors, having worked extensively in Marketing, Sales and Product Management roles at PECO II and Marconi Communications, Inc. Kevin holds a Bachelor of Science in Electrical Engineering from the University of Missouri and an MBA in Corporate Finance from the University of Dallas.

About Alpha Technologies

Alpha Technologies Ltd. develops power conversion, protection and standby products for Telecommunications and Broadband Cable industries, including custom and application-specific powering. By developing an intimate understanding of specific powering needs combined with over 40 years of powering innovation and expertise, Alpha's distinctive excellence is the ability to quickly develop solutions tailored to solve our customers' unique powering challenges. Visit Alpha at www.alpha.ca

As a member of The Alpha Group, ATL is part of a global alliance of companies that share a common philosophy – to create world class powering solutions for communication, commercial, industrial and renewable energy markets.

Alpha Technologies Ltd.

Canada: Burnaby, British Columbia • T: 604 436 5900 • F: 604 436 1233

United States: Bellingham, Washington • T: 360 647 2360 • F: 360 671 4936

Alpha Technologies reserves the right to make changes to the products and information contained in this document without notice.
Copyright © 2017 Alpha Technologies. All Rights Reserved. Alpha® is a registered trademark of Alpha Technologies.
member of The Alpha Group™ is a trademark of Alpha Technologies.

For more information visit www.alpha.ca

Rev A (07/2017)

member of The  Group™