

# DM31 DOCSIS® 3.1 Transponder for XM3™ Power Supply Quick Start Guide

## Introduction

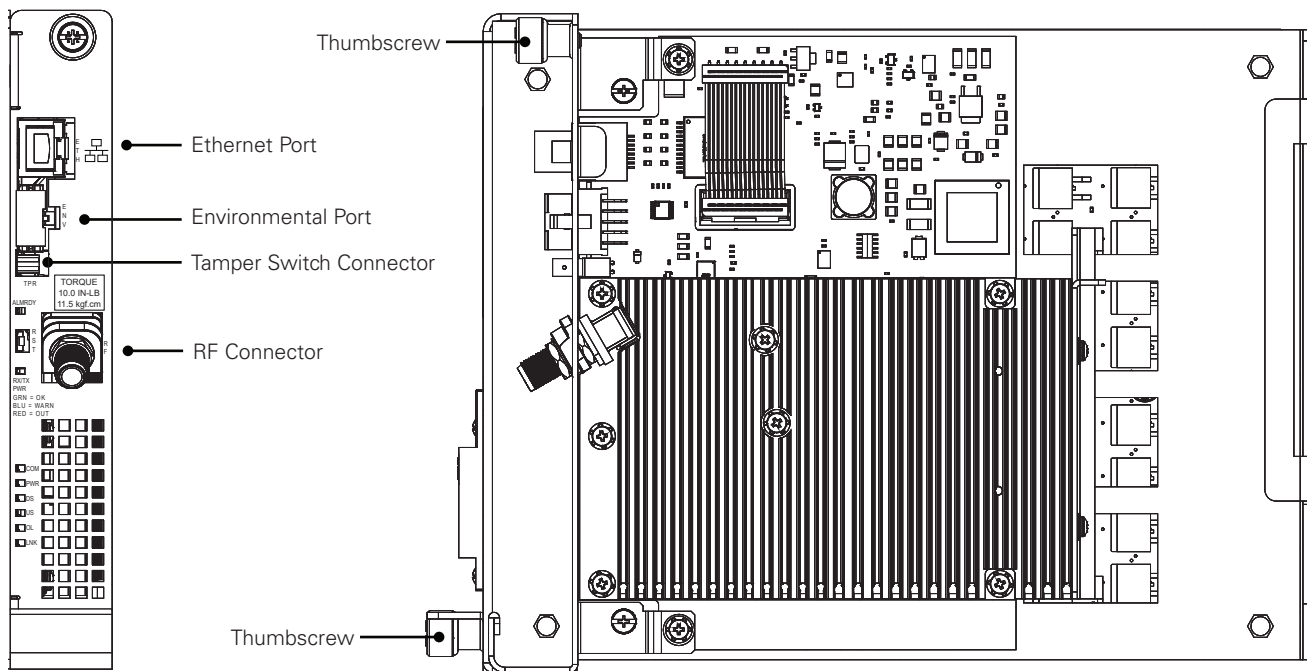
This guide describes the DOCSIS Monitor 31 (DM31) transponder and provides procedures with regard to installation in the XM3 series broadband uninterruptible power supply (UPS). This guide also provides steps to verify correct network provisioning on the DOCSIS network. For detailed information, refer to the DM31 Technical Manual available at [www.alpha.com](http://www.alpha.com).

## Audience

This guide is intended for experienced, qualified and licensed installation personnel familiar with the mechanical and electrical requirements of enclosure and power supply systems. Review the support documentation on the website to become familiar with the features and functions of the equipment in this system before proceeding. Failure to install and/or use this equipment as instructed in the system documents can result in a hazard to personnel or damage to the equipment. This system is only serviceable by qualified personnel.

## Overview

The DM31 unit is a DOCSIS 3.1 transponder designed to provide status and alarms from the XM3 broadband UPS to a network monitoring system. The DM31 transponder utilizes Simple Network Management Protocol (SNMP), standard SCTE-HMS and Alpha Management Information Bases (MIBs) to provide network status monitoring and diagnostics. A web interface enables authorized personnel direct access to advanced diagnostics using a common web browser. The DM31 transponder is composed of the following:



LED Indicators			
<b>ALM/RDY</b>	DM31 ready, major/minor alarm	<b>DS</b>	Downstream RF carrier detection/lock
<b>Rx/Tx PWR</b>	RF power level	<b>US</b>	Upstream RF carrier detection/lock
<b>COM</b>	XM3 communications	<b>OL</b>	Registration lock
<b>PWR</b>	DM31 power	<b>LNK</b>	Ethernet link

Fig. 1, DM31 Transponder

# Installation / Replacement Procedure

Before removing the Inverter Module, verify the power supply device address is set to a valid number. Power supplies must have 1, 2, 3, 4 or 5 as an address (not 0).


- To verify the power supply's address, go to the LCD Smart Display on the inverter module and enter the **PWR CNFG** menu.
- Scroll to the **DEVICE ADDRESS** menu item and verify the device address is set to something other than 0 (zero).

 **NOTICE:**

Industry standard board replacement procedures should be followed. To reduce static, Alpha® recommends the use of a static reducing wrist strap.

**Removing the Inverter Module:**

1. Turn off the battery breaker.
2. Disconnect the battery input and temperature sensor cables from the inverter module, followed by the tamper and RF if a transponder is currently installed.
3. Loosen the thumbscrew on the XM3™ power supply inverter module and the thumbscrew on the transponder (if applicable).
4. Grasp the handle on the bottom right side of the inverter module. Pull firmly to release the module from the inverter connector. Gently slide the module assembly straight out until the inverter module is accessible.

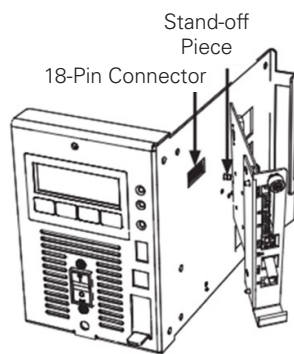
 **NOTICE:**

For XM3™ power supplies in service, backup battery power will not be available during this procedure.

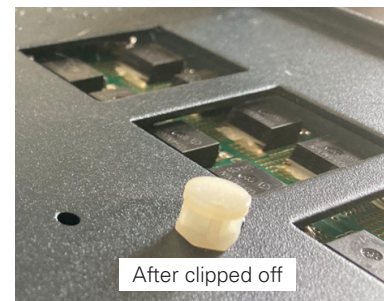
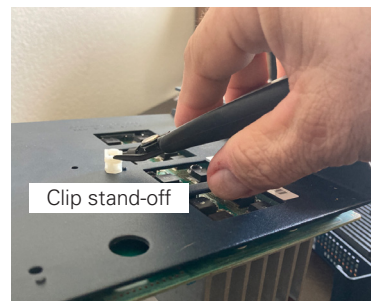
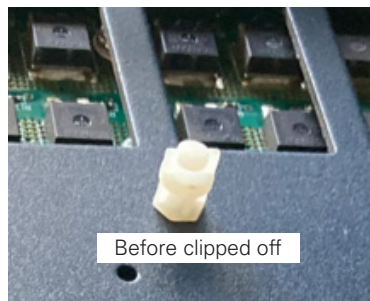
 **CAUTION!**

Service personnel must verify the inverter module battery breaker remains in the OFF position until instructed to return the unit to service.

5. If applicable, remove the old transponder from the inverter module.
6. The white stand-off on the side of the inverter module should be snipped off to avoid interference with the DM31 transponder assembly (Fig. 2). Use wire cutters to snip the stand-off.

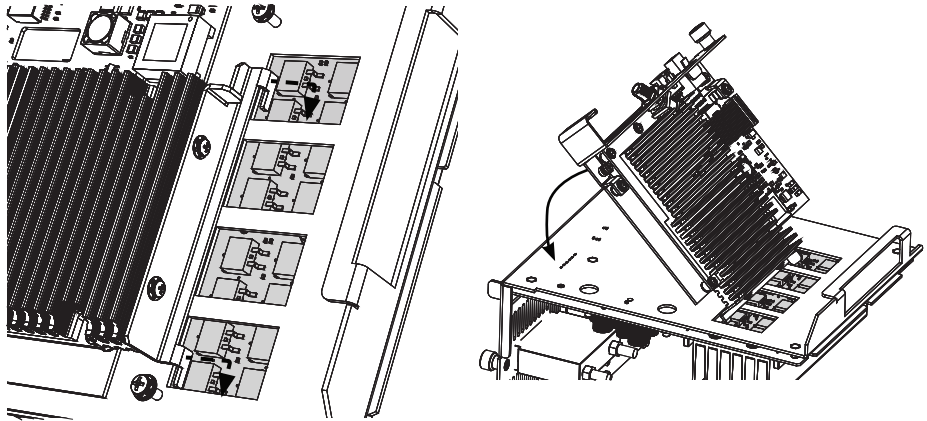


To ease the installation process, remove the ribbon from the transponder and connect to the inverter.



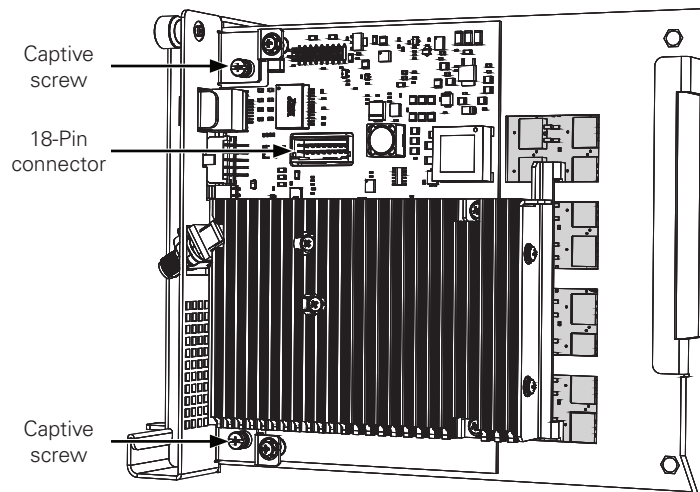
**Fig. 2, Modifying Stand-off**

- Center and angle the latch bracket tabs of the transponder and insert them in the slots as shown in Fig. 3. Lower the transponder down so it's flush with the bracket. Ensure the PCBA slot is centered with the 18-pin connector (Fig. 4).



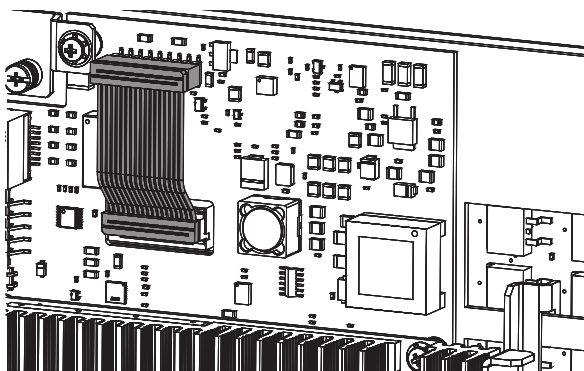
**Fig. 3, Rear Bracket Connection**

- Fasten the transponder to the Inverter Module by tightening the two captive screws (Fig. 4). It is recommended that the screws be tightened alternately, a few turns at a time, so the transponder aligns in parallel to the Inverter Module.

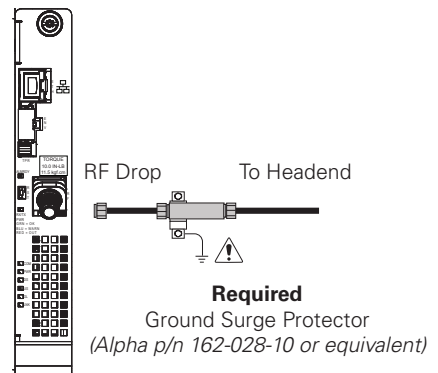


**Fig. 4, Captive Screws**

- Install the 18-pin ribbon cable between the DM31 transponder and the inverter module (Fig. 5).
- Reinstall the Inverter Module, tighten the two thumbscrews and reconnect the front panel connections (tamper, temperature sensor, battery harness, etc.).
- Verify the recording of the cable modem MAC address (RF MAC) by navigating to the XM3™ power supply Smart Display's **COMM** menu.
- Connect the RF drop as shown in Fig. 6. The DOCSIS® specification for downstream power level is  $\pm 15$  dBmV. However, for optimal performance, set the level as close to 0 dBmV as possible. RF attenuators may be required to obtain optimal downstream (receive) RF levels.



**Fig. 5, Ribbon Cable Installation**



**Fig. 6, RF Cable Installation**

## Initial Power-Up and Test / Return Unit to Service

1. Plug the power supply into the AC outlet.
2. Switch battery breaker ON.
3. The transponder LED indicators will all blink in unison upon initial power up. The RDY indicator will then begin blinking steadily indicating normal processor activity.
4. Verify the DS and OL indicators are on solid. This verifies the Communications Module has registered an IP address on the network.
5. Verify the RF indicator is solid green, indicating Upstream and Downstream Power is within the default specified range and the Upstream RF Power is below the recommended +50 dBmV (Table 1).
6. Verify no XM3™ power supply alarms are active.

RF Power Default Values		
LED Color	Rx Range (dBmV)	Tx Range (dBmV)
Green	+10 to -10	0 to +50
Blue	+15 to +10 and -10 to -15	+50 to +55
Red	>+15 and <-15	>+55

Table 1, RF Power Default Values

## Verify Communications

### XM3 Power Supply Smart Display - COMM Menu

Verify the DM3.1 Series transponder communication parameters such as IP address, RF Power Levels and Signal/Noise Ratio on the **COMM** menu of the XM3 power supply Smart Display. Press **ENTR** to open the **COMM-GENERAL** menu enabling the operator to view values for communications parameters. Pressing the up or down arrow softkeys will show two lines of information for each submenu item (Fig. 7).

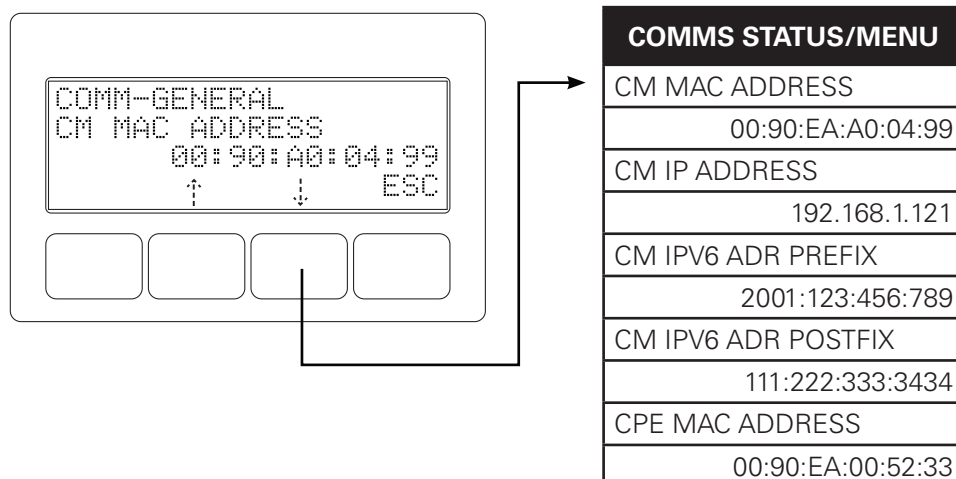


Fig. 7, COMM Status/Menu

## Local Web Server Access:

The connection may be tested by using a computer and a standard Ethernet cable. Connect the computer to the Ethernet port on the transponder, launch a web browser (e.g. Chrome) and enter 192.168.100.1 in the address field. The "Overview" page, as shown below, will appear and display connectivity, power levels and power supply status information such as alarms, output voltage, output current and individual battery voltages. System Name, System Location, System Contact and Common Logical ID may be edited on this page; when prompted for a User Name and Password, use "Alpha" and "AlphaGet".

## Remote Web Server Access:

Connect the computer to the cable modem network, launch a web browser (e.g. Chrome) and enter the designated transponder IP address in the address field. The "Overview" page will appear (Fig. 8).

The screenshot displays the 'Overview' page for an XM3-908HP transponder. The page is organized into several summary sections:

- Alarm Summary:** 0 major, 0 minor, 1 nominal, 37 disabled. Includes a link for 'Alarm settings...'.
- Power Supply Summary:**

Major Alarm	OK	Δ
Minor Alarm	No SAG harness	Δ
Operational Mode	Line	
Inverter Status	Off	Δ
Output Power	0 W	Δ
- Batteries Summary:**

Battery String Voltage	28.80 V	Δ
Charger Mode	Off	
Charger Current	0.00 A	
Battery Temperature	-40 °C -40 °F	Δ
- DOCSIS Summary:**

Cable Modem Status	Online	
Cable Modem IP Address	192.168.20.108/24	
Cable Modem MAC Address	00.90.EA.2A.EC.CB	
Downstream Power	-9.2 dBmV	Δ
Upstream Power	31.5 dBmV	Δ
- System Data Summary:**

System Name	sysName not set	
System Location	sysLocation not set	
System Contact	3basic.cfg	
Logical ID	DM3.1	
Up Time	0d 0h 13m 15s	

At the bottom of the page, there are links for 'CSV' and 'Excel' exports, and a copyright notice: 'Copyright © 2017-2022 EnerSys. All Rights Reserved. www.alpha.com | www.enersys.com'.

Fig. 8, Remote Server Web Page - Overview