



an EnerSys® company

# AlphaCell® XTV Battery User Guide

Effective: February 2021



# Safety Notes

Alpha Technologies Services, Inc. considers customer safety and satisfaction its most important priority. To reduce the risk of injury or death, and to ensure continual safe operation of this product, Alpha® tries to adhere to ANSI Z535 and encourages the customer to pay special attention and care to information presented in each safety notification.

Each section in this manual contains important safety information that must be followed during the installation and maintenance of the equipment and batteries. Read all of the instructions before installing or operating the equipment and save this manual for future reference.



## **WARNING! GENERAL HAZARD**

GENERAL HAZARD WARNING provides safety information to PREVENT INJURY OR DEATH to the technician or user.



## **WARNING! ELECTRICAL HAZARD**

ELECTRICAL HAZARD WARNING provides electrical safety information to PREVENT INJURY OR DEATH to the technician or user.



## **WARNING! FUMES HAZARD**

FUMES HAZARD WARNING provides fumes safety information to PREVENT INJURY OR DEATH to the technician or user.



## **WARNING! FIRE HAZARD**

FIRE HAZARD WARNING provides flammability safety information to PREVENT INJURY OR DEATH to the technician or user.

There may be multiple warnings associated with the call out. Example:



## **WARNING! ELECTRICAL & FIRE HAZARD**

This WARNING provides safety information for both Electrical AND Fire Hazards



## **CAUTION!**

CAUTION provides safety information intended to PREVENT DAMAGE to material or equipment.



## **NOTICE:**

NOTICE provides additional information to help complete a specific task or procedure.

## **ATTENTION:**

ATTENTION provides specific regulatory/code requirements that may affect the placement of equipment and /or installation procedures.

# AlphaCell® XTV Battery User Guide

Storage, Maintenance and Deployment

745-680-B13-001, Rev. C

Effective Date: February 2021

© 2021 by Alpha Technologies Services, Inc.

## Disclaimer

Images contained in this manual are for illustrative purposes only. These images may not match your installation.

Operator is cautioned to review the drawings and illustrations contained in this manual before proceeding. If there are questions regarding the safe operation of this powering system, please contact Alpha Technologies Services, Inc. or your nearest Alpha® representative.

Alpha shall not be held liable for any damage or injury involving its enclosures, power supplies, generators, batteries or other hardware if used or operated in any manner or subject to any condition not consistent with its intended purpose or is installed or operated in an unapproved manner or improperly maintained.

## Contact Information

Sales information and customer service in USA

(7AM to 5PM, Pacific Time):

+1 800 322 5742

Complete technical support in USA

(7AM to 5PM, Pacific Time or 24/7 emergency support):

+1 800 863 3364

Sales information and technical support in Canada:

+1 888 462 7487

Website:

[www.alpha.com](http://www.alpha.com)

# Contents

Safety Notes .....	2
AlphaCell® XTV Battery Safety Notes.....	6
Electrical Safety .....	6
Chemical Hazards .....	6
Mechanical Safety .....	7
Battery Maintenance Guidelines.....	7
Recycling and Disposal Instructions.....	8
Transportation Information .....	8
Important Storage Practices .....	9
1.0 Introduction .....	10
1.1 Description.....	10
1.2 Operating Conditions .....	12
1.3 Capacity.....	12
1.3.1 Ratings .....	13
2.0 Preparing for Maintenance .....	17
2.1 Required Tools and Equipment.....	17
2.2 Inspection of Cabinet.....	17
2.3 Pad Undermining .....	18
2.4 Inspection of Indicator Lamps.....	18
2.5 Ground Integrity .....	18
2.6 Surge Suppression/SPI Alt Box .....	18
2.7 Inspect All Wiring and Power Supply .....	18
2.8 Remove all Dirt, Dust and Debris from the Cabinet.....	18
3.0 Battery Maintenance Procedure.....	19
3.1 Battery Visual Inspection .....	19
3.2 Power Supply Charger Evaluation.....	20
3.3 Battery Test Evaluation Using Float Voltage .....	20
3.4 Battery Test Evaluation Using Conductance Reading .....	21
3.5 Battery Test Evaluation using Power Supply Self-Test .....	21
3.6 Battery Redeployment Procedure Using 24-hour Open Circuit Voltage Test .....	21
3.3 PM Certification Report.....	23
3.4 Battery Evaluation Procedures for AlphaCell® XTV .....	25
4.0 Battery Float Charging .....	26
5.0 Troubleshooting .....	27
6.0 Battery Specifications by Model Number.....	30
7.0 Warranty and Return Information .....	31
7.1 AlphaCell® XTV Limited Warranty .....	31
7.2 Battery Maintenance Report for Return Authorizations .....	33

# Figures

Storage Time vs. Temperature Graph .....	9
Fig. 1-1, Series String Configuration of Batteries .....	10
Fig. 1-2, 36Vdc Parallel Battery Strings.....	11
Fig. 1-3, Terminal Stack (Fused and Unfused).....	11
Fig. 1-4, Estimated Available Capacity vs. Battery Temperature.....	12
Fig. 3-1, Flow Chart for Battery Refurbishment Plan.....	22
Fig. 3-2, PCM Certification Report.....	23
Fig. 3-3, PCM Certification Report, Part 2.....	24

# Tables

Table 1-1, AlphaCell 100XTV Rating .....	13
Table 1-2, AlphaCell 150XTV Rating .....	14
Table 1-3, AlphaCell 195XTV Rating .....	15
Table 1-4, AlphaCell 240XTV Rating .....	16
Table 3-1, Battery Test Evaluation Using Float Voltage.....	20
Table 3-2, Conductance Values, Healthy vs. Suspect Batteries.....	25
Table 4-1, Recommended Charge Settings.....	26
Table 5-1, Troubleshooting .....	27
Table 5-1, Troubleshooting, continued.....	28
Table 5-1, Troubleshooting, continued.....	29
Table 6-1, Battery Specifications, AlphaCell XTV Models .....	30
Table 7-1, Warranty Periods for AlphaCell XTV Batteries .....	32

# AlphaCell® XTV Battery Safety Notes

Review the drawings and illustrations contained in this manual before proceeding. If there are any questions regarding the safe installation or operation of the system, contact Alpha Technologies Services, Inc. or the nearest Alpha® representative. Save this document for future reference.

To reduce the risk of injury or death, and to ensure the continued safe operation of this product, the following symbols have been placed throughout this manual. Where these symbols appear, use extra care and attention.



## WARNING! ELECTRICAL HAZARD

Any liquid emissions from a valve-regulated lead-acid (VRLA) battery contains dilute sulfuric acid, which is harmful to the skin and eyes. Emissions are electrolytic and are electrically conductive and corrosive.



## WARNING! ELECTRICAL HAZARD

- Lead-acid batteries contain dangerous voltages, currents, and corrosive material. Battery installation, maintenance, service, and replacement must only be performed by authorized personnel.
- Alpha® highly recommends fusing in single and parallel string configurations.

## Electrical Safety

Lethal voltages are present within the power supply and electrical enclosures. Never assume that an electrical connection or conductor is not energized. Check circuits with a volt meter prior to any installation or removal procedure.

- Observe circuit polarities.
- Always work with another technician when working under hazardous conditions.
- Ensure no liquids or wet clothes contact internal components.
- Hazardous, electrically live parts exist inside uninterruptible power supplies (UPS), and are energized from the batteries even when the AC input power is disconnected.
- Use an insulated blanket to cover exposed portions of the battery system when performing extended maintenance that could result in personal or equipment contact with the energized conductors.
- Certain types of rectifier circuits used in charging the battery may not include a line isolating transformer. In these cases, extreme caution should be used when maintaining and collecting data on the battery system.

## Chemical Hazards

*To avoid injury:*

- Servicing and connection of batteries shall be performed by, or under the direct supervision of, personnel knowledgeable of batteries and their required safety precautions.
- Always wear eye protection, rubber gloves, and a protective vest when working near batteries. To avoid battery contact, remove all metallic objects, such as rings or watches.
- Batteries produce explosive gases. Keep all open flames and sparks away from batteries.
- Use tools with insulated handles, do not rest any tools on top of batteries.
- Batteries contain or emit chemicals known to the State of California to cause cancer and birth defects or other reproductive harm. Battery post terminals and related accessories contain lead and lead compounds. Wash hands after handling (California Proposition 65).
- If any battery emission contacts the skin, wash immediately and thoroughly with water. Follow your company's approved chemical exposure procedures.

- Neutralize any spilled battery emission with the special solution contained in an approved spill kit, or with a solution of 1 pound (454g) sodium bicarbonate in 1 gallon (3.8L) of water. Report a chemical spill using your company's spill reporting structure and seek medical attention if necessary.
- Always replace batteries with those of an identical type and rating (**match conductance, voltages, and date codes as specified in this document**).
- Never install old or untested batteries.
- Prior to handling the batteries, touch a grounded metal object to dissipate any static charge that may have developed on your body.
- Use special caution when connecting or adjusting battery cabling. An improperly connected or unconnected battery cable can make contact with an unintended surface that can result in arcing, fire, or possible explosion.
- A battery showing signs of cracking, leaking, or swelling should be replaced immediately by authorized personnel using a battery of identical type and rating.

## Mechanical Safety

Keep hands and tools clear of fans.

- Fans are thermostatically controlled and will turn on automatically.
- Power supplies can reach extreme temperatures under load.
- Use caution around sheet metal components, especially sharp edges.
- Depending on the model, batteries can weigh anywhere from 25 to 100 pounds (11kg to 45kg). Exercise care when handling and moving batteries. Use proper handling equipment.

## Battery Maintenance Guidelines

For optimal performance, inspect batteries every 6 months for:

**Signs of battery cracking, leaking or swelling.** The battery should be replaced immediately by authorized personnel using a battery of the identical type and rating (**match conductance, voltages, and date codes as specified in this document**).

**Signs of battery cable damage.** Battery cable should be replaced immediately by authorized personnel using replacement parts specified by vendor.

**Loose battery connection hardware.** Refer to documentation for the correct torque and connection hardware for the application.

- Do not attempt to remove the vents (valves) from the AlphaCell® XTV battery or add water. This is a safety hazard and voids the warranty.
- Apply NO-OX® grease on all exposed connections.
- When necessary, clean up any spilled electrolyte in accordance with all federal, state, and local regulations or codes.
- Follow approved storage instructions.
- Always replace batteries with those of an identical type and rating. Never install untested batteries.
- Do not charge batteries in a sealed container. Each individual battery should have at least 1/2 inch of space between it and all surrounding surfaces to allow for convection cooling.
- All battery compartments must have adequate ventilation to prevent an accumulation of potentially dangerous gas. **Never place batteries in a sealed enclosure.** Extreme caution should be used when maintaining and collecting data on the battery system.

# Recycling and Disposal Instructions

- Spent or damaged batteries are considered environmentally unsafe as they contain lead and dilute sulfuric acid. They should not be "thrown away" with common refuse.
- Always recycle used batteries in accordance with federal, state, provincial, and local regulations. Alpha Technologies Services, Inc. provides recycling services. Call 1-800-863-3930, visit [www.alpha.com/BatteryRecycling](http://www.alpha.com/BatteryRecycling), or contact your local Alpha® representative.

# Transportation Information

All AlphaCell® XTV batteries are identified as "Battery, Electric Storage, Wet, Nonspillable" when transported by air, sea or by land transportation. The battery(s) must be identified as above on the Bill of Lading and properly packaged with their terminals protected from short circuit. NA or UN numbers do not apply. AlphaCell XTV battery(s) warning label identifies each battery as NONSPILLABLE.

AlphaCell XTV sealed lead-acid batteries are classified as "Nonspillable" for the purpose of transportation by DOT, and IATA/ICAO as result of passing the Vibration and Pressure Differential Test described in DOT [49 CFR 173.159(f)] and IATA/ICAO [Special Provision A67]. AlphaCell XTV sealed lead-acid batteries can be safely transported on deck, or under deck stored on either a passenger or cargo vessel as result of passing the Vibration and Pressure Differential Tests as described in the IMDG regulations (Special Article 238).

To transport these batteries as "Nonspillable," the terminals must be protected from short circuit and the battery must be securely packaged to withstand normal shipping conditions. AlphaCell XTV Batteries packed accordingly are considered unregulated and require no additional special packaging or handling.

For all modes of transportation, each battery and outer package is labeled "NON-SPILLABLE" per 49 CFR 173.159(f). If repackaging batteries or including batteries as a component of another product, the outer packaging must be labeled "NON-SPILLABLE" per 49 CFR 173.159(f).



# Important Storage Practices

## During storage please note:

- All lead acid batteries experience self-discharge while in open circuit storage. This causes circuit voltage and capacity to decrease.
- The self-discharge rate is related to ambient temperature. The lower the temperature, the lower the discharge rate. batteries should be stored in a clean, ventilated, and dry location with an ambient temperature of 32°F to 77°F (0°C to 25°C).
- It is important to track open circuit voltage which is related to the density of the electrolyte. If the open circuit voltage is lower than 12.6V or the batteries have been stored beyond the limits shown in the Storage Time vs. Temperature graph below, the batteries should be charged to avoid damage caused by self-discharge.
- Recharge at 14.4V for 12 hours prior to battery reaching 12.6Vdc.
- All batteries should be fully charged before storage. Record the storage date and next supplemental charge date in a maintenance record and on the battery.
- Upon battery deployment, verify all batteries within each string measure in the range of +/- 0.3Vdc of the string average while in "float" charger mode.



### NOTICE:

The product warranty could be voided if the batteries are not stored and recharged in accordance with these guidelines.

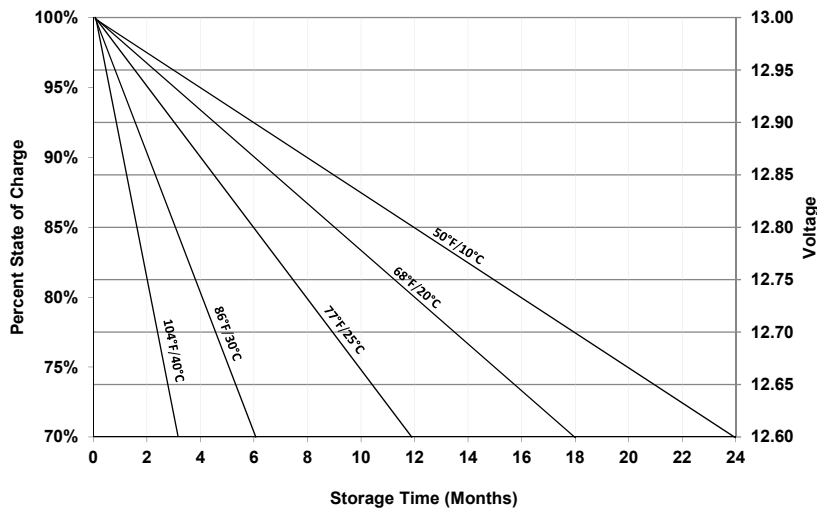

Storage Time vs. Temperature Graph

# 1.0 Introduction

The purpose of this guide is to provide the user with the necessary information to maintain batteries in storage and deploy batteries in Alpha® powering systems, as well as perform battery testing, install replacements and recycling.

This manual guides you through periodic maintenance checks and troubleshooting of the AlphaCell® XTV Extreme Temperature AGM battery.

Adherence to the procedures and practices detailed in this guide will not only insure the battery operates per specifications, but also provides the proper backup for the Alpha powering system in which it is installed.

To achieve these goals, this guide will address the following topics:

- The storage and maintenance of new battery inventory.
- Deployment of AlphaCell® XTV batteries into Alpha power systems.
- Proper preventative maintenance practices for AlphaCell® XTV batteries.
- Replacement and recycling of AlphaCell® XTV batteries.
- Warehousing, testing, and redeployment of reusable AlphaCell® XTV batteries.
- How to keep proper maintenance records for troubleshooting and/or Warranty claims.

## 1.1 Description

The AlphaCell® XTV battery is a lead acid battery that facilitates an oxygen recombination cycle.

A 12V battery is made up of six 2V cells internally connected to provide 12 volts.

The battery system is a group of 12V batteries connected in a series string to provide a higher voltage system. In Fig. 1-1, three of the nominal 12V batteries are connected in series to provide an 18 cell system with a nominal voltage of 36V, and four of the nominal 12V batteries are connected in series to provide a 24 cell system with a nominal voltage of 48V.

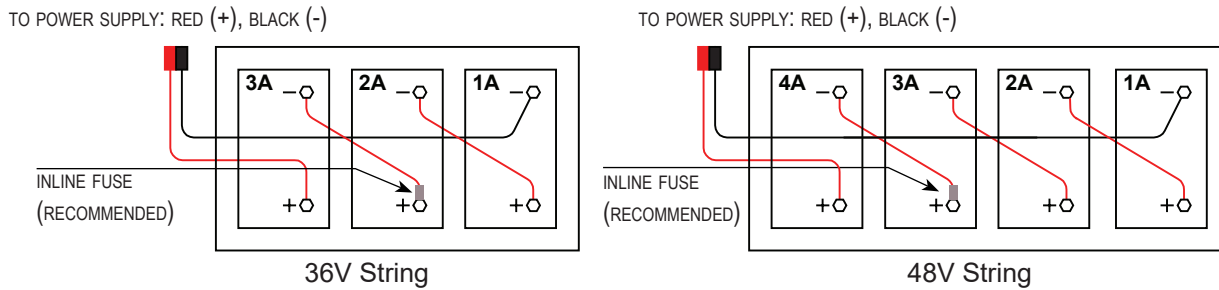

Fig. 1-1, Series String Configuration of Batteries

You can connect multiple strings of batteries in parallel. This provides a system whose capacity equals the sum capacity of all the strings. For example, in Fig. 1-2, two 36V 110Ah capacity strings are connected in parallel to provide a nominal 36V at 220Ah.



**WARNING! ELECTRICAL HAZARD**

Alpha highly recommends fusing in single and parallel string configurations.

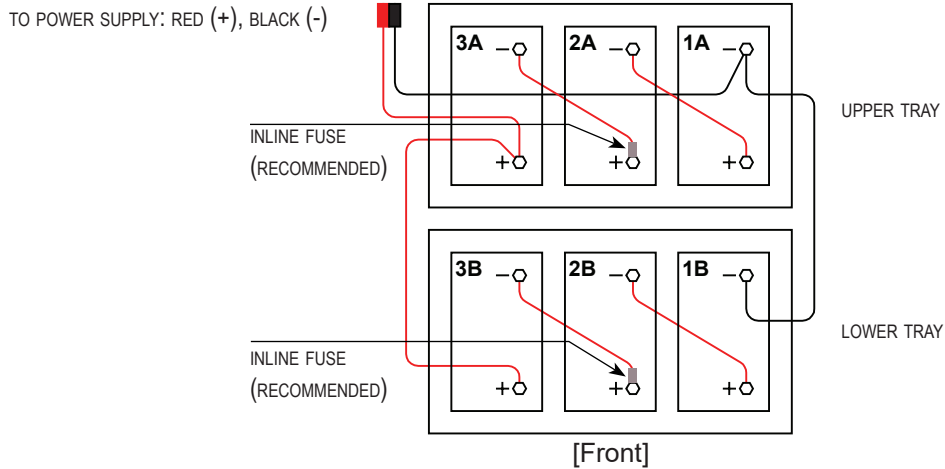

Fig. 1-2, 36Vdc Parallel Battery Strings

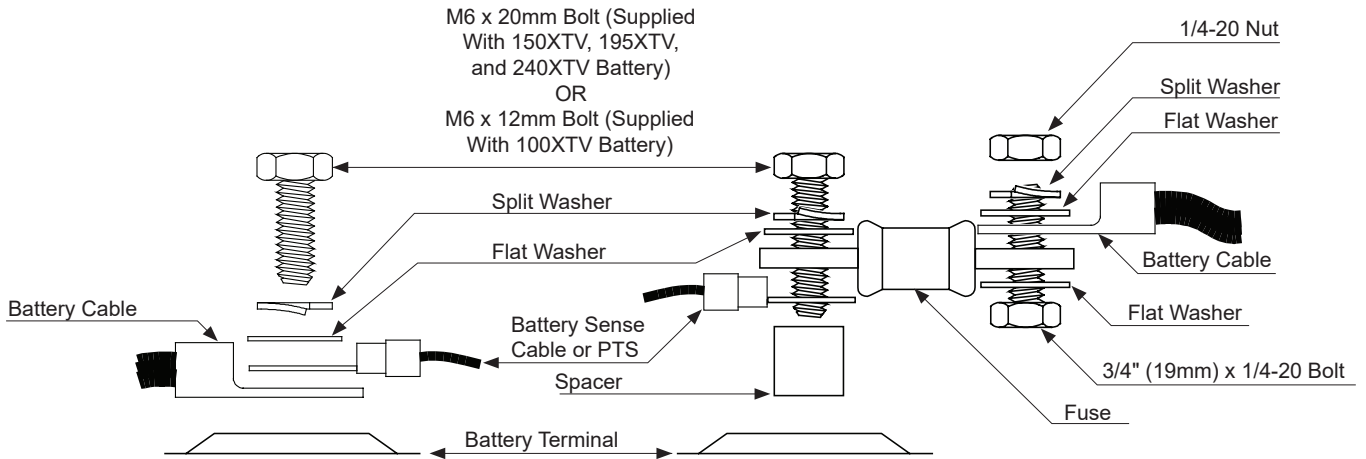

Fig. 1-3, Terminal Stack (Fused and Unfused)

## 1.2 Operating Conditions

AlphaCell® XTV batteries are valve regulated and virtually sealed, and do not give off perceptible amounts of gas under normal operating conditions.

- Acceptable ambient operating temperature: -40°F to 140°F (-40°C to 60°C)
- Ideal ambient operating temperature: 68°F to 77°F (20°C to 25°C)
- Ambient humidity: ≤ 95%

## 1.3 Capacity

The actual capacity is related to the utilization ratio of the active positive and negative materials within the battery. The utilization ratio is influenced by the depth of discharge, the structure of the battery, and the manufacturing technology. During normal usage, the factors that influence the actual capacity are discharge rate, depth of discharge, end voltage, and temperature.

- The higher the discharge rate, the lower the available capacity.
- As batteries get colder, the available capacity is reduced. This is related to the kinetics of the electrochemical reactions and the resistivity of the electrolyte (See Fig. 1-4).



**NOTICE:**

Although the battery can be operated at temperatures below -4°F (-20°C), the capacity and ability to discharge will be dramatically decreased.

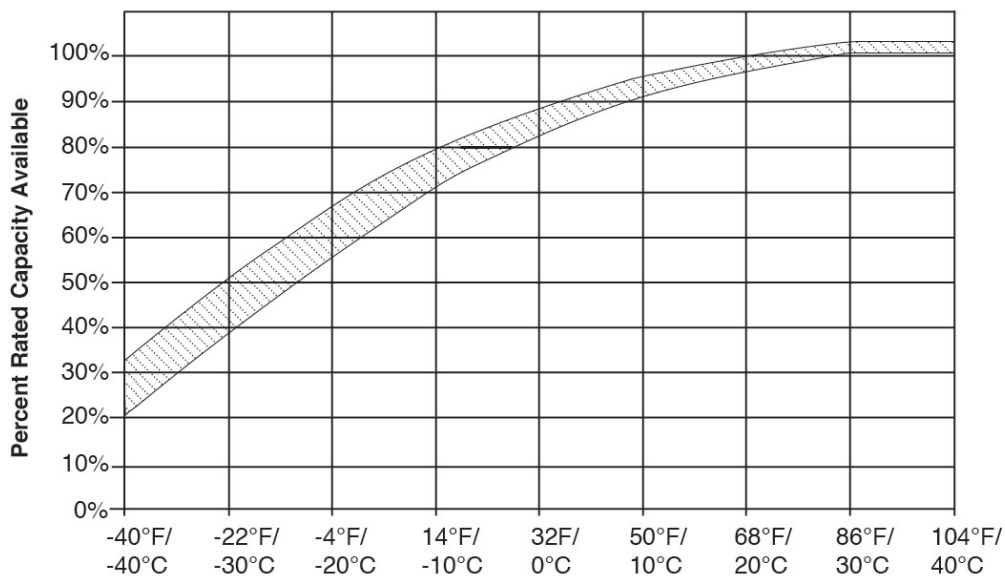

Fig. 1-4, Estimated Available Capacity vs. Battery Temperature



**NOTICE:**

When operating batteries at extreme cold temperatures (-40°C/-40°F) it is recommended to properly size battery strings to the expected load. In these conditions, single strings of 100XTV, 150XTV, 195XTV, 240XTV are not recommended at output CATV loads above 10, 12, 15 and 18AMP respectively for 90VAC without the addition of battery heater mats. Contact your Alpha® Sales representative for battery heater mat information.

## 1.0 Introduction, continued

### 1.3.1 Ratings

#### AlphaCell® 100XTV

Capacity in Ampere Hours (77°F/25°C)										
End Voltage/ Time	15min	30min	60min	90min	2hr	3hr	5hr	8hr	10hr	20hr
1.67V	29.8	35.1	40	42.8	45	48.3	52.5	54.64	55.5	56
1.70V	29.3	34.8	39.7	42.5	44.8	48	52	53.92	54.8	55.8
1.75V	28	34	39.4	42	44.2	47.4	51.5	53.6	54.1	55
1.80V	26.3	32.5	38.1	41	43.4	46.2	50.5	52.32	53.1	54.6
1.85V	23.1	30.3	36.2	39.2	41.6	44.4	48.4	50.24	50.9	52.8

Constant Current Discharge in Amperes (77°F/25°C)										
End Voltage/ Time	15min	30min	60min	90min	2hr	3hr	5hr	8hr	10hr	20hr
1.67V	119	70.1	40	28.5	22.5	16.1	10.5	6.83	5.55	2.8
1.70V	117	69.5	39.7	28.3	22.4	16	10.4	6.74	5.48	2.79
1.75V	112	67.9	39.4	28	22.1	15.8	10.3	6.7	5.41	2.75
1.80V	105	64.9	38.1	27.3	21.7	15.4	10.1	6.54	5.31	2.73
1.85V	92.5	60.6	36.2	26.1	20.8	14.8	9.7	6.28	5.09	2.64

Constant Power Discharge Watts Total (77°F/25°C)										
End Voltage/ Time	15min	30min	60min	90min	2hr	3hr	5hr	8hr	10hr	20hr
1.67V	1282.8	780	457.8	331.2	261	187.2	121.8	80.22	65.58	34.38
1.70V	1267.8	769.8	454.2	330	259.8	186	121.2	79.68	65.1	34.2
1.75V	1221	760.8	451.2	327	259.2	184.8	120	78.72	64.2	33.9
1.80V	1147.2	733.8	442.8	321	255	181.8	118.2	77.7	63.42	33.42
1.85V	1,030.2	688.2	418.8	309	244.8	175.2	115.2	74.82	61.08	32.28

Table 1-1, AlphaCell 100XTV Rating

AlphaCell® 150XTV

Capacity in Ampere Hours (77°F/25°C)										
End Voltage/ Time	15min	30min	60min	90min	2hr	3hr	5hr	8hr	10hr	20hr
1.67V	37.8	45.7	54.2	59.7	62.6	66	71	75.36	77.5	82.2
1.70V	37	45.4	53.8	59.3	62.2	65.7	70.5	75.04	77.3	81.6
1.75V	35.5	44.1	53	58.4	61.2	64.8	69.5	74.16	76.5	80
1.80V	32	41.8	51.3	57	59.8	63.6	68	72.96	75.3	79.2
1.85V	28	38.9	48.3	54.3	57	60.3	65	69.76	72.3	76.2

Constant Current Discharge in Amperes (77°F/25°C)										
End Voltage/ Time	15min	30min	60min	90min	2hr	3hr	5hr	8hr	10hr	20hr
1.67V	151	91.4	54.2	39.8	31.3	22	14.2	9.42	7.75	4.11
1.70V	148	90.8	53.8	39.5	31.1	21.9	14.1	9.38	7.73	4.08
1.75V	142	88.1	53	38.9	30.6	21.6	13.9	9.27	7.65	4
1.80V	128	83.5	51.3	38	29.9	21.2	13.6	9.12	7.53	3.96
1.85V	112	77.7	48.3	36.2	28.5	20.1	13	8.72	7.23	3.81

Constant Power Discharge Watts Total (77°F/25°C)										
End Voltage/ Time	15min	30min	60min	90min	2hr	3hr	5hr	8hr	10hr	20hr
1.67V	1618.2	1026	625.2	462	366	259.8	169.2	111	92.58	49.2
1.70V	1596	1014	621	459	363	258	168	109.98	92.52	49.02
1.75V	1516.8	996	613.8	454.2	361.2	256.2	166.8	109.02	91.8	48.48
1.80V	1396.8	951	594	444	352.2	250.8	165	108	89.82	47.82
1.85V	1242	898.2	559.8	424.2	334.8	241.8	157.8	106.02	86.88	45.9

Table 1-2, AlphaCell 150XTV Rating

AlphaCell® 195XTV

Capacity in Ampere Hours (77°F/25°C)										
End Voltage/ Time	15min	30min	60min	90min	2hr	3hr	5hr	8hr	10hr	20hr
1.67V	47	57	67.2	73.1	76.8	82.2	87.5	92	94.7	100.4
1.70V	46	56.5	66.7	72.5	76	81.9	87	91.2	94.5	100.2
1.75V	43.3	55	65.5	71.6	75.2	80.7	86.5	90.4	93.8	100
1.80V	39.3	52.2	63	69.5	73	78.3	84	89.6	91.6	96.8
1.85V	34.5	48.5	59.1	65.7	69.2	75.6	80.5	85.6	88.2	92.6

Constant Current Discharge in Amperes (77°F/25°C)										
End Voltage/ Time	15min	30min	60min	90min	2hr	3hr	5hr	8hr	10hr	20hr
1.67V	188	114	67.2	48.7	38.4	27.4	17.5	11.5	9.47	5.02
1.70V	184	113	66.7	48.3	38	27.3	17.4	11.4	9.45	5.01
1.75V	173	110	65.5	47.7	37.6	26.9	17.3	11.3	9.38	5
1.80V	157	104.3	63	46.3	36.5	26.1	16.8	11.2	9.16	4.84
1.85V	138	96.9	59.1	43.8	34.6	25.2	16.1	10.7	8.82	4.63

Constant Power Discharge Watts Total (77°F/25°C)										
End Voltage/ Time	15min	30min	60min	90min	2hr	3hr	5hr	8hr	10hr	20hr
1.67V	2029.2	1285.8	775.2	567	447	321	210	136.98	112.98	59.58
1.70V	1987.2	1273.8	771	564	445.2	319.2	208.8	136.02	112.02	59.28
1.75V	1879.8	1245	760.8	556.8	439.8	316.2	207	135	111	58.98
1.80V	1726.8	1192.2	735	544.8	429	307.8	202.8	133.02	109.98	58.08
1.85V	1546.2	1125	694.8	519	412.2	297	193.8	129	105	55.92

Table 1-3, AlphaCell 195XTV Rating

AlphaCell® 240XTV

Capacity in Ampere Hours (77°F/25°C)										
End Voltage/ Time	15min	30min	60min	90min	2hr	3hr	5hr	8hr	10hr	20hr
1.67V	57.8	68.5	83.8	84.6	93.1	97.9	101.0	105.6	107.0	112.4
1.70V	56.6	68.0	83.4	84.0	92.1	97.6	100.0	104.8	106.0	112.2
1.75V	52.8	66.0	81.7	82.5	91	96.3	99.0	104.0	105.0	112
1.80V	47.9	62.4	78.1	79.6	88.2	93.4	96.0	102.4	103.0	108.5
1.85V	41.5	57.9	72.5	74.6	83.3	89.6	92.4	97.5	99.3	104.9

Constant Current Discharge in Amperes (77°F/25°C)										
End Voltage/ Time	15min	30min	60min	90min	2hr	3hr	5hr	8hr	10hr	20hr
1.67V	231.4	137.1	83.8	56.4	46.6	32.6	20.2	13.2	10.7	5.62
1.70V	226.3	136.1	83.4	56.0	46	32.5	20.0	13.1	10.6	5.61
1.75V	211	132.0	81.7	55.0	45.5	32.1	19.8	13.0	10.5	5.60
1.80V	191.6	124.9	78.1	53.1	44.1	31.1	19.2	12.8	10.3	5.43
1.85V	41.5	115.8	72.5	49.7	41.6	29.9	18.5	12.19	9.95	5.24

Constant Power Discharge Watts Total (77°F/25°C)										
End Voltage/ Time	15min	30min	60min	90min	2hr	3hr	5hr	8hr	10hr	20hr
1.67V	2464.8	1538.4	883.8	646.8	537.6	382.2	239.4	156	126	67.8
1.70V	2413.8	1531.2	951	645	536.4	381	237.6	155.4	125.4	67.2
1.75V	2294.4	1486.8	931.8	633.6	528	377.4	234.6	154.2	124.2	67.2
1.80V	2092.8	1432.8	894	611.4	513	366.6	231.6	151.2	123	66
1.85V	1869.6	1343.4	835.2	577.8	487.2	354	221.4	147	119.4	63

Table 1-4, AlphaCell 240XTV Rating



## 2.0 Preparing for Maintenance

Each site must be physically inspected every 12 months, at minimum. Measurement of electrolyte specific gravity, as well as adding water to individual battery cells, is not necessary. All batteries in the string should be numbered to facilitate recording and analysis of data unique to each unit.

Notify anyone affected by the intended maintenance or troubleshooting activity. This should include but not be limited to anyone responsible for the status monitoring equipment at the Central Office head-end or Network Operations Center.

### 2.1 Required Tools and Equipment

Prior to beginning maintenance, ensure that all recommended tools and equipment, including safety equipment, is available and functional.

The following is a list of the recommended equipment:

- True RMS digital voltmeter
- Conductance meter
- Infrared temperature sensor
- Socket wrenches, insulated
- Box end wrenches, insulated
- Torque wrenches calibrated inch/lbs
- Rubber gloves
- Full face shield
- Safety glasses
- Plastic apron
- Hard hat
- Portable eyewash
- Spill kit, including sodium bicarbonate solution
- Fire extinguisher
- NO-OX<sup>®</sup> corrosion inhibitor
- Paper towels and/or rags
- Plastic soft bristle brush
- Spare battery terminal hardware and cables

### 2.2 Inspection of Cabinet

Upon arrival, the technician will do a visual inspection of the cabinet at the site location. This will consist of an inspection of the door, latches, hinges, lights and other indicators, and overall condition of the system.

1. Inspect power supply cabinet security and condition.
2. Inspect cabinet for integrity (securely mounted, service meter and conduit integrity, etc.)
3. Inspect cabinet for unwanted critters (i.e., rodents, poisonous spiders, poisonous snakes, fire ants, etc.)
4. Do a visual inspection for any sign of corrosion.
5. Verify the cabinet door opens and closes properly.
6. Check all locks and hinges for proper operation and lubricate if necessary.
7. Determine if the battery tray is operating properly by verifying it slides in and out without sticking.
8. If there is brush surrounding the enclosure, remove any overgrowth.

## **2.0 Preparing for Maintenance, continued**

9. Identify if enclosure is located in a designated flood plain.
10. For overhead applications, note the distance from the bottom of the power supply to the ground.

## **2.3 Pad Undermining**

1. For ground-level applications, inspect the soil surrounding the enclosure. Verify that the soil has not eroded away from the enclosure causing the cabinet to lean.
2. Report any issues to the supervisor.

## **2.4 Inspection of Indicator Lamps**

1. Locate any installed indicator lamps and verify indicators are functioning correctly.
2. Replace defective lamps.

## **2.5 Ground Integrity**

1. Inspect the ground rod and ensure it complies and meets NEC, NESC or local authority having jurisdiction.
2. Inspect the ground wire cable clamps and enclosure ground lug and make sure the connection is secure.
3. Verify the ground/bond wire is #6 AWG at a minimum.
4. Verify tight connections at both ends of the ground/bond wire. Appropriate bolts or clamps should be used and all bonds should be clean and free of corrosion.

## **2.6 Surge Suppression/SPI Alt Box**

1. Inspect the surge suppressor and replace if needed. If the LED indicator is not illuminated for the LAP, it will need to be replaced.
2. Verify the SPI/Alt Box is tight, along with the coaxial connection, ensuring that the power supply and sheath of coax is grounded. Make sure the Alt Box is not loose and is secured properly to the coax cable at the back of the cabinet.
3. Visually inspect the SPI/Alt Box wires to verify they are in good working condition with the Anderson connectors.
  - Burnt or melted wires or Anderson Connectors are an indication of bad wires.
  - Anderson Connectors may show signs of discoloration. This is an indication that they need to be replaced.

## **2.7 Inspect All Wiring and Power Supply**

1. Inspect the breakers and receptacles and verify they are functioning properly.
  - Inspect breaker to ensure proper size for power supply, and if it is a single pole breaker, the breaker must be of a high magnetic type.
  - Examine the AC output on both sides of the receptacle. Replace if cracked.
2. Do not test the power supply standby functionality until after the batteries have been tested. Verify the battery breaker is in working condition and the unit will go into standby mode.
3. Verify the display on the Inverter Module is functioning. Replace the display if it does not appear.
4. Visually inspect the battery cables for secure connections and any evidence of corrosion.
5. Record any active alarms.

## **2.8 Remove all Dirt, Dust and Debris from the Cabinet**

To clean the enclosure, it is recommended to use a vacuum, leaf blower or damp rag. Once the cabinet inspection is complete, proceed to check the batteries.

## 3.0 Battery Maintenance Procedure

As part of a comprehensive Preventative Maintenance program, a technician must verify that all system batteries are operating correctly. When performing service and maintenance on batteries, always follow recommended safety practices and wear personal protective equipment. It is recommended to perform battery maintenance checks when the ambient temperature is between 32°F (0°C) and 100°F (38°C). It is recommended to follow each of the steps listed below to ensure batteries have been tested properly.

### 3.1 Battery Visual Inspection

1. Verify the batteries that make up a single string are of the same make and model. Any string consisting of a mixture of makes or models should be completely replaced.
2. Verify battery date codes do not exceed agreed upon age.
3. Physically inspect the batteries. The technician should look for leaking, cracking, swelling, discoloration and/or excessive terminal corrosion.

Suspect batteries should be removed immediately by switching off the battery breaker, disconnecting the battery and removing it from the enclosure. Any battery suspected of leaking should be placed in a plastic bag, the bag tied close, and then placed in a second bag. The bagged battery should then be placed into a cardboard box for safe transport to the designated battery collection location.

The same double-bag procedure should be used for all contaminated cleaning rags at the end of the shift. Batteries should be transported in their shipping cartons or with the terminals protected to prevent short circuits.

4. Use baking soda and water to clean any corrosion or excessive dirt from the battery itself and the battery tray. Neutralize any suspect surfaces until all bubbling/foaming from the baking soda stops.
5. If the corrosion is confined to the battery terminal itself (battery is not suspected of leaking), a plastic bristle brush and/or Scotch-Brite®-style pad may be required to remove corrosion from the battery terminals and battery cables. It is recommended to replace any hardware or cables where the corrosion has pitted or removed significant amounts of the cable lug plating.
6. Inspect battery terminals for proper hardware stack – note that the main battery cable should be next to the battery terminal itself, and that locking hardware is present. Verify the battery terminal hardware is torqued to proper specification.
7. Slide batteries apart to maximize space between batteries to ensure proper air circulation. A ½” of space is recommended, however, a minimum of a ¼” space is required.
8. Verify the RTS (Remote Temperature Sensor) or PTS (Precision Temperature Sensor) is properly installed to provide the power supply with the battery temperature for proper temperature compensation for the battery charger. Refer to the power supply manual for proper installation procedure.
9. After battery testing is complete and if batteries are deemed good and serviceable, treat the battery posts with corrosion inhibitor.

### 3.0 Battery Maintenance Procedure, continued

## 3.2 Power Supply Charger Evaluation

1. Verify the correct battery model, number of strings and/or battery capacity was selected in the power supply settings.
2. Ensure power supply is in “Float” charger mode.
3. With the battery breaker on, measure the string voltage at the main positive and negative terminals of the battery string. Log the string voltage on maintenance report.
4. If the power supply charger is equipped with temperature compensation, note battery temperature from the power supply display and log this temperature on maintenance report.
5. Ensure float charge voltage for the string is within +/- 0.3mV of the temperature compensated charger voltage.

**Example:** For a 36 Volt / 3 battery string system

Nominal charger voltage at 77°F (25°C) = 40.5Vdc

Temperature compensation = .005 Volts per °C per Cell.

Battery temperature = 15°C at time of inspection.

Nominal charger voltage calculation 25°C-15°C = 10 degrees x (.005 x 18 cells) = .9V + 40.5V = 41.4Vdc Charge Voltage

## 3.3 Battery Test Evaluation Using Float Voltage

It is recommended to perform battery maintenance checks when the ambient temperature is between 32°F (0°C) and 100°F (38°C).

1. With the battery breaker on and after confirming the power supply charger is in Float mode and outputting the proper charge voltage above, measure each individual battery’s float voltage within the string and log into the maintenance log.
2. Battery Float Voltage readings are temperature dependent. Use the following table to determine suspect batteries.
3. Turn off battery breaker prior to replacing batteries. Do not perform self-test on known bad batteries.
4. Although float voltage evaluation is a good indication of a battery approaching end-of-life, further evaluation of the battery via conductance and self-test is required to determine if replacement is required. Proceed to step 4.4.

Temperature	Battery OK	Battery Suspect	Replacement Candidate
32°F / 0°C	>13.6 Vdc	≤13.6 Vdc	<13.0 Vdc
54.5°F / 12.5°C	>13.4 Vdc	≤13.4 Vdc	<12.8 Vdc
77°F / 25°C	>13.1 Vdc	≤13.1 Vdc	<12.5 Vdc
88.5°F / 31.5°C	>13.0 Vdc	≤13.0 Vdc	<12.4 Vdc
100°F / 38°C	>12.8 Vdc	≤12.8 Vdc	<12.2 Vdc

Table 3-1, Battery Test Evaluation Using Float Voltage

### 3.0 Battery Maintenance Procedure, continued

## 3.4 Battery Test Evaluation Using Conductance Reading

Conductance values are expressed with siemens (mhos) values. These values are directly affected by temperature. As a general rule of thumb, for every 2°F drop in temperature below 77°F, the siemens reading should be adjusted up by 0.7%.

1. Turn the battery breaker off.
2. Allow the batteries to sit idle for one minute to stabilize.
3. Following the conductance meter manufacturer's instructions, perform a conductance test on each battery (using Midtronics® meter or similar). Log the voltage and conductance readings in the maintenance log. Measure and record the battery temperature in the maintenance log. Temperature compensate the measured values and record in the maintenance log. It is recommended to replace a battery when conductance readings are 40% of the initial or published value for a new battery.

Example: Battery temperature: 67°F, Measured conductance value: 880 S

Compensated Reading:  $(1 + (((77 - 67) / 2) * 0.007)) * 880 = 911$

4. Assuming that a battery has an initial (or new published value) siemens reading of 1000 mhos, follow the guidelines suggested below:
  - For readings below 400 mhos, replace the battery.
  - For readings between 400-800 mhos, it is considered a marginal reading and it requires a 10-minute self-test as outlined in Section 5.5 below.

## 3.5 Battery Test Evaluation using Power Supply Self-Test

1. Initiate a 10-minute self-test via the front panel display of the power supply if this feature is supported.
2. Record the readings of the individual battery voltages in the 9th minute of the self-test. (It is important to measure all of the individual battery voltages before the self-test completes to ensure you get an accurate voltage reading while under load and before entering a charging state.)
3. If any battery voltage falls below 10.8 Volts, then that battery should be replaced if it is less than 2 years old. If it is greater than 2 years old then the string replacement is recommended. See Section 4.6 for possible redeployment procedures of potentially good batteries.

*This concludes the field battery maintenance portion of the procedure.*

## 3.6 Battery Redeployment Procedure Using 24-hour Open Circuit Voltage Test

**(Performed in the warehouse on batteries removed from the field but under consideration for redeployment.)**

Battery strings that fail the self-test may have batteries that are still healthy enough for redeployment. "Good batteries" can be redeployed if they are grouped with other "Good batteries" of the same make and model with like date codes, voltages and conductance readings when redeployed. Batteries should be redeployed within 60 days of removal.

1. After returning batteries to the warehouse, recharge at 14.40V for 12 hours.
2. Remove from charger and let stand open circuit for 24 hours. Measure the battery voltages and log. Any battery measuring below 12.60V should be recycled.
3. Any battery above 12.60V is a candidate for redeployment. Proceed to flow chart below.

3.0 Battery Maintenance Procedure, continued

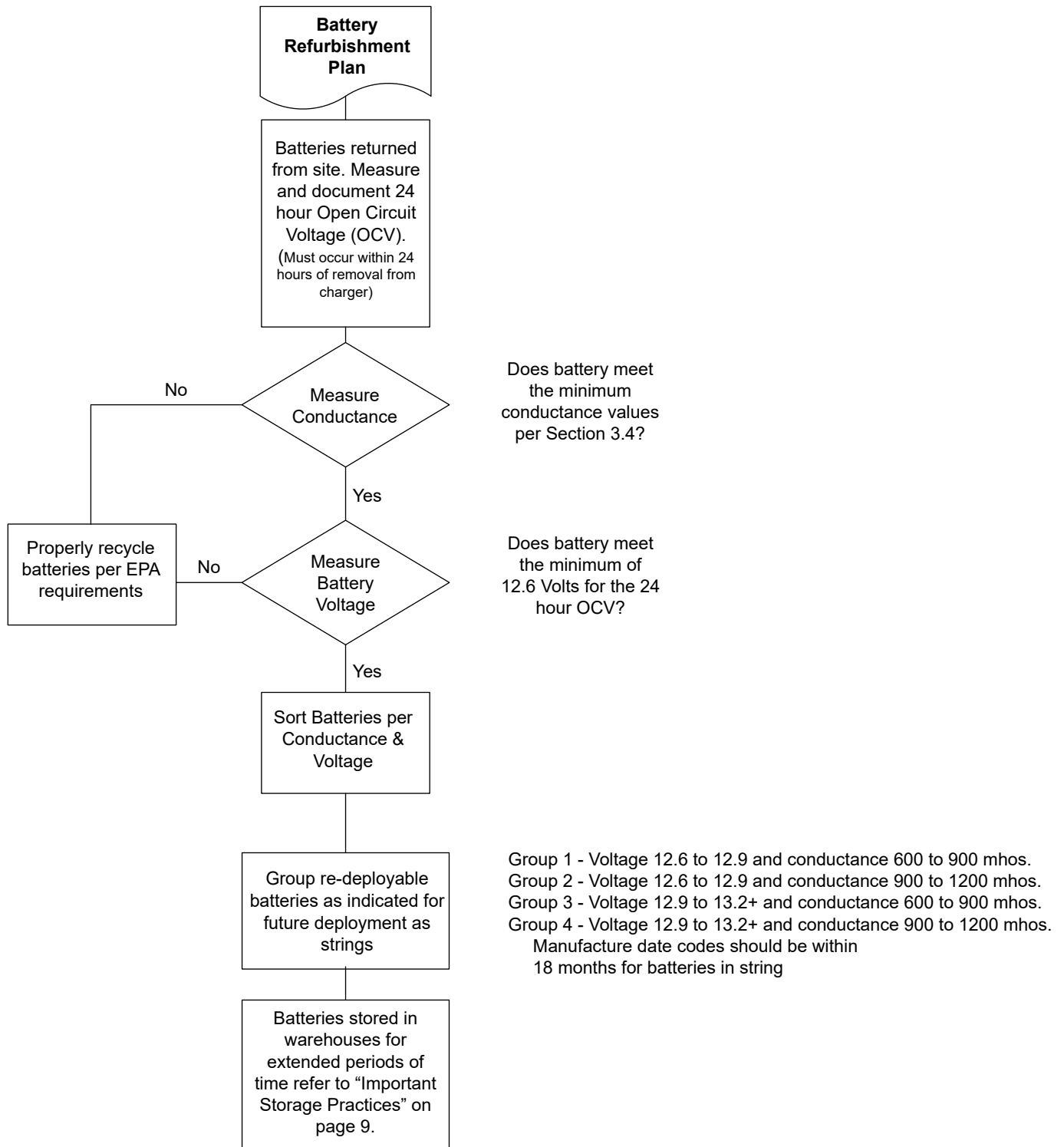

Fig. 3-1, Flow Chart for Battery Refurbishment Plan

### 3.0 Battery Maintenance Procedure, continued

### 3.3 PM Certification Report

Follow this sample when filling out the maintenance log (following page).



Site Data		SAMPLE				Site ID: SAMPLE	
Latitude	Longitude	Date	Time	Transformer #			
Hub	City	State / Province	Zip Code				
Region	System	Node	Country				
Project ID	Street(s)	Utility Company	Pole #				
Business Service	Utility Account #	Utility Meter #	Powering A Node				

Transponder Data					
CM Mac Address	SNR	CER	Logic Card	Transmit Power	Receive Power
CM IP Address	Transponder Type	Firmware Version	T3 Timeouts	T4 Timeouts	
SNMP TRAPS					
Trap 1	Trap 2	Trap 3	Trap 4		
Alpha MIB 1	Alpha MIB 2	Alpha MIB 3	Alpha MIB 4		
UPSTREAM					
Frequency	Modulation	Lock	Channel ID	Symbol Rate	
DOWNSTREAM					
Frequency	Modulation	Lock	Channel ID	Symbol Rate	

Power Supply Data						
Make-Model	Date Code (MMYY)	Refurb Date (MMYY)	Self-Test Duration (min)			
Firmware Version	Total Run Days	Event Log Cleared	Self-Test Interval (days)			
PIM/DOC Installed	Output VAC	120V Or 240V?				
Power Supply #	PowerSupplyEvents		AC Input Voltage (VAC)	Output Voltage (VAC)	Output Current (A)	
	Number	Time			Primary (1)	Secondary (2 - If Present)
PS1						

Battery Data							
Self-Test Verified	Self-Test Start Time	Self-Test Finish Time	Battery Temperature (°F / °C)				
Battery #	Battery Manufacturer	Date Code (MMYY)	ID #	Voltage No Load (VDC)	Voltage Under Load (VDC) After 9 Minute Self-Test	BS Conductance (mhos)	
						Meter Reading	Corrected 77°F
A1							
A2							
A3							
A4							
Battery Separator Present		String A Total		String A Fused			
B1							
B2							
B3							
B4							
Battery Separator Present		String B Total		String B Fused			
CHARGER INFO							
Charger Mode	Charger Current	Accept (V/C)	Charger Current Limit				
Float (V/C)	Temp Comp (mV)						

3.0 Battery Maintenance Procedure, continued



**PM CERTIFICATION REPORT**  
 INSTALL | MAINTAIN | REPAIR | VALIDATE



**As-Found Local Power Supply Alarms**

Alarm	Major/ Minor	Tech Notes/ Actions Taken	Cleared On Site

**Inspection**

**Enclosure Exterior Maintenance Checklist**

Item To Check	Yes/No	Item To Check	Yes/No	Item To Check	Yes/No
Check For Pad Undermining		Clean Dust/Dirt From Enclosure Inside		Enclosure Hardware Tightened	
ACI Installed & Functioning		LRI Installed & Functioning		Enclosure Snow Shield	
Generator Accessibility		PS Co-Locate With Node		Dual Utility Switch Present	
Co-Locate With Vault		U-Guard On Ground Wire		PS Metered	
Control Switch Installed		Security Bar Present		Lock Present	
Enclosure Make-Model		Enclosure Condition		Enclosure Depth (cm)	
Internal Breaker		Service Entrance		Receptacle Type	
		UG Or Aerial			

**Interior Systems Maintenance Checklist**

Item To Check	Yes/No	Item To Check	Yes/No	Item To Check	Yes/No
Check Wire Harness And Connectors		Clean And NO-OX Batteries		Site Grounded Properly	
Tamper Installed And Functioning		AC TVSS Installed And Functioning		AlphaGuard Installed And Functioning	
Battery Hardware Properly Tightened		Coax TVSS Present		Battery Temperature Probe Present	
Pad Value		Cable Sim Value		Ground Current	
Tap Installed		Drop Installed		Generator Cord Present	

**Battery Heater Mat Types & Quantities**

Mat Type	Quantity	Mat Type	Quantity

**Work Items Performed On Site**

Work Item	Quantity	Part Number(s)

**Technician Info**

Open Items For Repeat Visit			
Initial X-Tractor & Form Time (minutes)		Additional Form Time (minutes)	
<b>PM Service Technician</b>			
Last Name	First Name	Contact #	Technician #

Fig. 3-3, PCM Certification Report, Part 2



### 3.0 Battery Maintenance Procedure, continued

## 3.4 Battery Evaluation Procedures for AlphaCell® XTV

To help identify batteries approaching end of life in an operating power system, Evaluation Procedure 1 should be performed at each maintenance interval. For batteries not installed in an operating power system, Evaluation Procedure 2 may be performed. For accuracy, tests must be performed on fully charged batteries.

A battery failing any of the following combined tests is defined as a faulty battery. The battery will be replaced under the terms of the warranty if within the defined warranty period.

### Evaluation Procedure 1

**Conductance/Impedance Test** – Measure the conductance of each battery. Any battery that possesses a conductance that is 50% less than the initial reading taken at the point of install can be considered suspect of being below 70% capacity and should be evaluated further. The battery temperature must be approximately the same each time this reading is taken (see Table 3-2 below). Use temperature compensation feature when using Midtronics® meter.

**AND**

**Float Voltage Test** – Measure the float voltage of each battery in the string that is on float charge. Any battery in the string measured at 13.2 volts or less is a suspect battery and should be further evaluated with the steps below. Any battery below 12.6 volts should be replaced. The 13.2 and 12.6 voltage values are based on a 77°F (25°C) temperature. Adjust the voltage for higher or lower temperatures by 0.0168 volts per battery per degree Fahrenheit. The higher the temperature above 77°F (25°C) the lower the voltage will have to be adjusted and vice-versa for temperature below 77°F (25°C). (i.e.: at a temp of 89°F (32°C) would have a corresponding float voltage of 13.0 volts).

### Evaluation Procedure 2

**Conductance/Impedance Test** – Measure the conductance of each battery. Any battery that possesses a conductance that is 50% less than the initial reading taken at the point of install can be considered suspect of being below 70% capacity and should be evaluated further. The battery temperature must be approximately the same each time this reading is taken (see Table 3-2 below). Use the temperature compensation feature when using Midtronics® meter.

**AND**

**24 Hour Open Circuit Test** – Measure the open circuit voltage of the suspected battery 24 hours after the battery has come off of float charge. Care must be taken to ensure that the battery is at full state of charge when it is disconnected from the power supply. The battery should exhibit a voltage about 12.60V. A battery below this voltage should be replaced. A fully charged battery below 12.6 volts is below 70% capacity, but a battery above 12.6 volts is not necessarily above 70% in capacity. Batteries that have been sitting for extended periods should be recharged after 6 months or when they reach 12.8 volts (75% capacity), which ever comes first depending on the storage temperature.

 **NOTICE:**

To maintain consistent test results, ensure the same Midtronics® conductance tester is used for each test cycle.

Midtronics® Conductance Models 3200/CELLTRON CTE-1200 AT	100XTV	150XTV	195XTV	240XTV
Approximate Conductance Values (mhos) Healthy Battery @ 77°F (25°C)	700-800	900-1100	1050-1250	1250-1550
Suspect Battery @ 77°F (25°C) in mhos	300	400	450	500

Table 3-2, Conductance Values, Healthy vs. Suspect Batteries

# 4.0 Battery Float Charging

## Battery System Float Charging Voltage

### Encountering temperature extremes

When you encounter temperature extremes, temperature compensate the float charging voltage. The temperature compensation coefficient is -0.0018 V/C per °F (-0.0033 V/C per °C).

For example if the normal battery temperature is 90°F (13° above 77°F) you should reduce the average float charging voltage by 0.0234 V/C (13° x -0.0018 V/C per °F) from 2.25 to 2.23 V/C.

If the battery operates at cold temperatures, (60°F, 17° below 77°F, for example), you can increase the charging voltage to improve recharging time.

For example, increase the charging voltage range by -17° x -0.0018 V/C per degree or 0.031 V/C.

### Under or overcharging

If the battery is undercharged for a period of time during which there are multiple discharges, the battery does not fully recharge after each discharge and provides progressively lower capacity.

Excessive overcharging causes premature aging of the battery and loss of capacity, noted by excessive float current, corrosion of the plate grids, and gassing and drying of the limited amount of electrolyte.

Severe overcharging over extended periods of time can induce a thermal runaway condition. This requires replacing the battery system.

 **NOTICE:**

The following set points are recommended for AlphaCell® XTV Batteries when used in an outdoor non-temperature controlled application.

AlphaCell® XTV Batteries	
Accept	2.35 V/C
Float	2.25 V/C
Temp Comp	-3.3mV/°C/C

Table 4-1, Recommended Charge Settings

## 5.0 Troubleshooting

Problem With	Symptom	Possible Causes	Possible Result	Corrective Actions
Capacity Test Results	Reduced operating time at 77°F (25°C) with smooth voltage decline	Normal life cycle	Eventual failure to support the load followed by potential for shorted cells.	Replace battery system when at 70% of rated capacity or before.
	Reduced operating time at 77°F (25°C) with steep voltage decline or voltage plateaus	Individual low capacity cells	Reversed cells during discharge. Reversed cells will become very hot and will not fully recharge.	Replace the isolated low capacity batteries.
	Excessive initial voltage drop, even to the point of dropping load in the first several seconds.	<ul style="list-style-type: none"> <li>Battery is extremely cold.</li> <li>Cable gauge too small.</li> <li>High resistance connections.</li> <li>Battery is undersized.</li> <li>Shorted cells.</li> </ul>	<ul style="list-style-type: none"> <li>Excessive voltage drop.</li> <li>Cells will become hot, could develop thermal runaway; internal arcing could result in an explosion.</li> </ul>	<ul style="list-style-type: none"> <li>Heat the battery.</li> <li>Run parallel cables or increase gauge of cables.</li> <li>Clean and reassemble connections.</li> <li>Add required parallel strings.</li> <li>Replace isolated units with shorts and evaluate entire string.</li> </ul>
Visual Battery Checks	Cover or container crack	Handling or impact damage	Cell dryout or ground fault. Potential internal gas ignition.	Replace damaged unit.
	Cover or container explosion	Ignition of cell internal gasses due to external source, fusing, or internal conductive path or internal spark due to shorting. Potential exists for ill-maintained batteries or those left in service beyond useful life.	<ul style="list-style-type: none"> <li>Personal injury and equipment damage at time of explosion.</li> <li>Failure to support load.</li> </ul>	Replace damaged unit and evaluate balance of string.
	Burned area on container	Crack in container wicking electrolyte to grounded rack/tray. Ground fault.	Could result in <ul style="list-style-type: none"> <li>Personal hazard due to conductive path to rack.</li> <li>Smoke or battery fire.</li> <li>Thermal runaway.</li> </ul>	Clear the ground fault and replace defective unit. Evaluate balance of string.
	Permanently deformed (swollen) container	Thermal runaway possible caused by high temperature environment, overcharging, excessively high recharge current, shorted cells, ground fault, or a combination of these.	Could result in the emission of hydrogen sulfide, detectable as a rotten egg odor, battery fire, and inability to support the load.	Replace the battery system, and correct the items leading to the thermal runaway condition.
	Rotten egg odor	Possible caused by high temperature environment, overcharging, excessively high recharge current, shorted cells, ground fault, or a combination of these.	Odor is a product of thermal runaway.	Replace the battery system and correct items leading to thermal runaway condition.
	Melted grease at terminals	Hot connections due to excessive resistance caused by loose connections, dirty contact surfaces or corrosion within connection.	<ul style="list-style-type: none"> <li>Excessive voltage drop perhaps leading to short operating time or damaged terminals.</li> <li>In extreme case could lead to melted terminal and ignition of the battery cover.</li> </ul>	<ul style="list-style-type: none"> <li>Clean and reassemble connection if damaged.</li> <li>Replace batteries with damaged terminals.</li> </ul>
	Corrosion at terminals	Possibly electrolyte leaking from battery terminal seal attacking the inter unit container.	Increased connection resistance and resulting increase in the connection heating and voltage drop at high rate discharge.	Disassemble connection, clean, coat connecting surfaces and terminal area seal with anti-oxidation grease, and reassemble the connection. If leakage about terminal area is obvious, the battery should be replaced.

Table 5-1, Troubleshooting

## 5.0 Troubleshooting, continued

Problem With	Symptom	Possible Causes	Possible Result	Corrective Actions
DC Voltage Checks	System float voltage > 2.3V/C average 77°F (25°C)	Charger output set incorrectly.	Overcharging causes excessive gassing and drying out of electrolyte, and contributes to potential thermal runaway.	Reset the charger output voltage to recommended value.
	System float voltage < 2.25V/C average 77°F (25°C)	Charger output set incorrectly.	Undercharging results in gradual loss of operating time and capacity with successive discharge cycles. If persistent, an irreversible level of lead sulfate develops on the plates resulting in a permanent capacity loss.	<ul style="list-style-type: none"> <li>Reset the charger output voltage to recommended value.</li> <li>Equalize battery system from 48 to 72 hours and perform capacity test. If capacity loss is permanent, replace the total battery system.</li> </ul>
	DC voltage measured between battery system output terminals and ground (rack/tray) or a ground fault indicated by automatic monitoring equipment.	Damaged container allowing electrolyte to wick out to grounded surface (rack/tray).	<ul style="list-style-type: none"> <li>Personnel shock hazard resulting in serious injury or electrocution.</li> <li>Potential burning of container at damaged area or battery fire.</li> </ul>	Determine the source of ground fault and replace battery.
Temperature Checks	Elevated room temperature	Lack of adequate air conditioning or ventilation.	Reduced battery life.	Cool room or accept reduced battery life.
	Elevated battery temp.	<ul style="list-style-type: none"> <li>Elevated room temp.</li> <li>Inadequate cabinet ventilation.</li> <li>Discharge - charge cycle.</li> </ul>	<ul style="list-style-type: none"> <li>Reduced battery life.</li> <li>Reduced life and potential thermal runaway.</li> <li>Normal if not exceeding 18°F/10°C increase.</li> </ul>	<ul style="list-style-type: none"> <li>Improve room air conditioning.</li> <li>Improve cabinet ventilation.</li> <li>Limit recharge current.</li> </ul>
	High current recharge	<ul style="list-style-type: none"> <li>High charging voltage.</li> <li>Shorted cells.</li> </ul>	Normal if not exceeding 18°F/10°C increase over ambient.	<ul style="list-style-type: none"> <li>Limit recharge current.</li> <li>Reduce within specifications.</li> <li>Replace shorted cells and evaluate total string..</li> </ul>
Float Charging Current Checks	Float current to string is zero.	A battery or connection in series string is open. Verify via the float voltage check or AC ripple voltage or impedance check of individual batteries.	<ul style="list-style-type: none"> <li>Failure to support load. If an internal arc occurs during discharge, can ignite gasses internal to cell.</li> <li>If there is an open/loose connection in external conductive path, can damage termination under load.</li> </ul>	Replace battery with open cell or repair open/loose external connection.
	Float current exceeds 3.0 milliamperes per ampere hour of rated capacity at 77°F(25°C) at float voltage.	<ul style="list-style-type: none"> <li>Batteries not fully recharged.</li> <li>Batteries above 77°F(25°C).</li> <li>Potentially shorted cells in battery.</li> <li>Depending on degree, battery entering or in thermal runaway.</li> </ul>	<ul style="list-style-type: none"> <li>Not at 100% capacity.</li> <li>Conducive to thermal runaway.</li> <li>Thermal runaway results in eventual meltdown of battery and potential of hydrogen sulfide emissions and fire.</li> </ul>	Determine specific cause; take corrective action.
Battery Impedance/Conductance Test	Impedance / resistance increase by 50% from original values or conductance decline to 50% of the value when new.	<ul style="list-style-type: none"> <li>Battery discharged or battery conductive path, plate grid or active material, or electrolyte volume deterioration.</li> <li>Shorted cells.</li> <li>Open cells.</li> </ul>	<ul style="list-style-type: none"> <li>Reduced operating time.</li> <li>Conducive to thermal runaway.</li> <li>Will not support load.</li> </ul>	Charge and retest battery or replace as required.

Table 5-1, Troubleshooting, continued

## 5.0 Troubleshooting, continued

Problem With	Symptom	Possible Causes	Possible Result	Corrective Actions
Connection Hardware Resistance / Tightness Check	Connection resistance increase 20% or more from original value.	<ul style="list-style-type: none"> <li>Repetitive cycles results in heating and cooling of connection, resulting in relaxation of torque, increase in connection resistance.</li> <li>Contamination within the connection results in corrosion and high terminal resistance.</li> </ul>	<ul style="list-style-type: none"> <li>Loose connections result in heat damaged or melted terminals during high rate discharge.</li> <li>Excessive voltage drop during high rate discharge and resulting reduced operating time.</li> </ul>	<ul style="list-style-type: none"> <li>Re-torque connection as required.</li> <li>Correct source of contamination, clean contact surface areas, grease contact surfaces with anti-oxidant grease, reassemble.</li> </ul>
	Connection hardware tightness is less than the specified "re-torque" value.	Repetitive cycles results in heating and cooling of connection resulting in relaxation of torque and increase in connection resistance.	Loose connections result in heat damaged or melted terminals during high rate discharge.	Re-torque the connection as required.
AC Ripple Voltage Checks	AC ripple (p-p) voltage on system >4% of the value of the DC float voltage	Poor filtering of charger output.	Excessive AC ripple could cause the battery to cycle at the ripple frequency and result in heating and deterioration of the plate active material.	Improve the charger output filtering.
	Individual battery in string exhibits AC ripple voltage twice that of other typical batteries in string.	Battery with high AC ripple voltage has proportionately higher impedance. Evaluate for performance. Subject battery could have deteriorating conductive path or dry, shorted or open cell.	<ul style="list-style-type: none"> <li>Reduced operating time.</li> <li>Potential conditions could be conducive to thermal runaway.</li> </ul>	Verify battery condition. Replace as required.

Table 5-1, Troubleshooting, continued

## 6.0 Battery Specifications by Model Number

Specifications	AlphaCell 100XTV	AlphaCell 150XTV	AlphaCell 195XTV	AlphaCell 240XTV
Operating Temperature Range (with Temperature Compensation):	-40 to 140°F / -40 to 60°C (Charger temp comp @ ±3.3mVpc per °C)			
Storage Temperature:	14 to 104°F / -10 to 40°C	14 to 104°F / -10 to 40°C	14 to 104°F / -10 to 40°C	14 to 104°F / -10 to 40°C
Self Discharge:	Battery can be stored up to 12 months at 77°F / 25°C. Higher temperatures during storage will require more frequent recharge.			
Voltage Per Unit:	12V	12V	12V	12V
Float Charge Voltage:	13.5 to 13.8Vdc average per 12V unit at 77°F / 25°C			
Refresh/Boost Charging Voltage:	14.4 to 15.0Vdc average per 12V unit at 77°F / 25°C			
Maximum AC Ripple (Charger):	0.5% RMS or 1.5% of float recommended for best results. Maximum voltage allowed = 4% P/P			
Terminal Type:	Threaded alloy insert terminal to accept M6 x 12mm bolt	Threaded alloy insert terminal to accept M6 x 20mm bolt		
Terminal Hardware Torque:	44.9 in-lbf / 5.1Nm	44.9 in-lbf / 5.1Nm	44.9 in-lbf / 5.1Nm	44.9 in-lbf / 5.1Nm
Case Size:	22NF	24	27	31
Dimensions H x L x W (in/mm):	8.17 x 9.01 x 5.46 / 207 x 228 x 139	8.44 x 10.85 x 6.65 / 214 x 276 x 169	8.43 x 12.71 x 6.67 / 214 x 323 x 169	8.57 x 13.50 x 6.71 / 218 x 343 x 170
Weight* (lb/kg):	39 / 17.7	56 / 25.4	67 / 30.5	75 / 34

\* Approximate \*\* Terminal hardware included with every battery

Battery	AlphaCell 100XTV	AlphaCell 150XTV	AlphaCell 195XTV	AlphaCell 240XTV
Runtime Rating 25Amp @ 77°F / 25°C to 1.75Vpc:	100 minutes	150 minutes	195 minutes	240 minutes
Ampere Hour Capacity 20Hr Rate @ 77°F / 25°C to 1.75Vpc:	56Ah	80Ah	100Ah	112Ah
Maximum Discharge Current:	300 Amperes	800 Amperes	800 Amperes	850 Amperes
Short Circuit Current:	1450 Amperes	1900 Amperes	2250 Amperes	2650 Amperes
Impedance 60Hz (approx.):	0.005	0.0045	0.0039	0.0034
Conductance Range Fully Charge New Battery @ 77°F / 25°C:	700 - 800	900 - 1100	1050 - 1250	1250 - 1550

Table 6-1, Battery Specifications, AlphaCell XTV Models

# 7.0 Warranty and Return Information

## 7.1 AlphaCell® XTV Limited Warranty

### Float Service Outdoor VRLA Batteries

This limited warranty applies only to the original purchaser ("User") of the Product supplied under the Supply Agreement. A Battery will be considered defective, and can be replaced, when it fails to deliver 70% of its rated capacity during stated warranty period provided that it has been used in accordance with the conditions listed below. Standard Warranty periods are outlined in Table 7-1.

When a defective Battery is identified the User should promptly notify the manufacturer. Should the manufacturer confirm the Batteries to be defective they will replace the material found to be defective F.O.B. its factory without charge except for freight.

#### CONDITIONS AND LIMITATIONS: (all claims are subject)

- 1) Warranty date is based on Ship Date code stamped on battery.
- 2) Warranty applies in accordance with Table 7-1.
- 3) The standard warranty shown in Table 7-1 applies to AlphaCell® XTV Batteries used in Alpha® enclosures in conjunction with Alpha Power Supplies.
- 4) A baseline Two Year Warranty applies to AlphaCell XTV Batteries used in other applications not defined in item #3 shown above. AlphaCell XTV batteries are not recommended for high cycling applications so please consult Alpha Applications Engineering for an alternative battery solution for high cycling applications. Extended warranties beyond two years may be available for unique enclosure/charger applications based on pre-approval by Alpha Engineering. Consult your salesperson for details.
- 5) Each Battery must be of proper size, design and capacity for its application in order for the warranty to apply.
- 6) Each Battery must be charged, discharged, stored and serviced in accordance with the AlphaCell XTV owners manual and user's guide.
- 7) Warranty is void if Battery is subject to misuse, abuse or physical damage or if Battery becomes unserviceable due to fire, wreckage, freezing, or any act of God.
- 8) Battery must be used with a temperature compensation charger having characteristic charging curves (voltage and current) acceptable with standard manufacturer's charging practices as outlined in the AlphaCell XTV owners manual and user's guide.
- 9) User agrees that the manufacturer's representative shall have access to equipment furnished hereunder for purpose of inspection at reasonable hours and intervals in order for the warranty to apply.
- 10) All defective and replacement Batteries, if returned, become property of the manufacturer.
- 11) Field Batteries replaced through limited warranty terms and conditions will receive the balance of original warranty.
- 12) Standard AlphaCell XTV Warranty requires a minimum semiannual preventive maintenance schedule with records as outlined in the AlphaCell XTV owners manual and user's guide.

#### CLAIMS:

- 1) Contact original point of purchase for instructions on applicable warranty claim procedures.
- 2) Upon satisfactory proof of claim as determined by the manufacturer, the manufacturer shall repair or replace, at its option, any defective Battery based upon the purchase price, exclusive of freight and labor.
- 3) The manufacturer does not accept any product for return, credit or exchange unless expressly authorized by the manufacturer in writing and returned prepaid to its plant.

ALPHA TECHNOLOGIES SERVICES, INC. SHALL NOT BE LIABLE FOR, AND USER SHALL INDEMNIFY AND SAVE ALPHA HARMLESS FROM ANY CLAIMS AND LIABILITIES ARISING OUT OF THE USE, MAINTENANCE, TRANSPORTATION, OR INSTALLATION OF ANY EQUIPMENT WARRANTED HEREUNDER. THE FOREGOING LIMITED WARRANTY IS IN LIEU OF ALL WARRANTIES EXPRESSED OR IMPLIED, INCLUDING ANY WARRANTY OF MERCHANTABILITY OR FITNESS FOR A PARTICULAR PURPOSE. THE SOLE LIABILITY OF ALPHA IS SET FORTH UNDER THE CLAIMS PARAGRAPH ABOVE. ALPHA SHALL NOT HAVE ANY LIABILITY FOR ANY SPECIAL INCIDENTAL INDIRECT OR CONSEQUENTIAL DAMAGES. THIS LIMITED WARRANTY APPLIES ONLY TO THE ORIGINAL PURCHASER (USER) OF THE EQUIPMENT, AND IS NON-TRANSFERABLE.

## 7.0 Warranty and Return Information

The table below indicates the warranty periods for AlphaCell® XTV Batteries used with Alpha® approved power supplies and enclosures.

Model	Warranty USA/Canada	Warranty World Wide Stable Grid
100XTV	5 years	4 years
150XTV	5 years	4 years
195XTV	5 years	4 years
240XTV	5 years	4 years

Contact Alpha Technologies Services, Inc. at 1-800-322-5742 for excluded countries and cycling applications.

Table 7-1, Warranty Periods for AlphaCell XTV Batteries







an EnerSys® company

**Alpha Technologies Services, Inc. | 3767 Alpha Way, Bellingham, WA 98226, USA**

Tel.: Toll Free North America: +1 800 322 5742 | Outside US: +1 360 647 2360 | Technical Support: +1 800 863 3364  
For more information visit our website at: [www.alpha.com](http://www.alpha.com)

© 2021 Alpha Technologies Services, Inc. All Rights Reserved. Trademarks and logos are the property of Alpha Technologies Services, Inc. and its affiliates unless otherwise noted. Subject to revisions without prior notice. E.&O.E. Midtronics is a trademark of MIDTRONICS, INC. NO-OX is a registered trademark of Mind Head LLC. Scotch-Brite is a registered trademark of 3M Company.

745-680-B13-001, Rev. C (02/2021)