



| an EnerSys® company

# Cordex® CXPS-E3 Edge Power Systems

**User Guide ID:** 9400016-J0

**Effective:** 02/2023



**Read this document carefully.**

Learn how to protect your equipment from damage and fully understand its functions.



# Cordex<sup>®</sup> CXPS-E3 300 A, 400 A, 600 A, 900 A Edge Power Systems



## NOTICE

For the latest version of software, firmware, and product documentation, visit the Alpha<sup>®</sup> website, [www.alpha.com](http://www.alpha.com) or [www.alpha.ca](http://www.alpha.ca).



## NOTICE

Photographs contained in this document are for illustrative purposes only. These photographs may not match your installation.



## NOTICE

Operator is cautioned to review the drawings and illustrations contained in this document before proceeding. If there are questions regarding the safe operation of this powering system, contact Alpha Technologies Ltd. or your nearest Cordex<sup>®</sup> power system representative.



## NOTICE

Alpha Technologies Ltd. shall not be held liable for any damage or injury involving its enclosures, power supplies, generators, batteries, or other hardware if used or operated in any manner or subject to any condition inconsistent with its intended purpose, or if installed or operated in an unapproved manner, or improperly maintained.

## Copyright notice

© 2023 Alpha Technologies Ltd., an EnerSys company. All Rights Reserved. Trademarks and logos are the property of EnerSys and its affiliates except for ANSI<sup>®</sup>, CSA<sup>®</sup>, IEC<sup>®</sup>, IEEE<sup>®</sup>, NEC<sup>®</sup>, National Electrical Code<sup>®</sup>, NO-OX-ID<sup>®</sup>, Scotch-Brite<sup>®</sup>, UL<sup>®</sup>, and Underwriters Laboratories<sup>®</sup>, which are not the property of EnerSys. Subject to revisions without prior notice. E.&O.E.

No part of this documentation shall be reproduced, stored in a retrieval system, translated, transcribed, or transmitted in any form or by any means manual, electric, electronic, electromechanical, chemical, optical, or otherwise without prior explicit written permission from Alpha.

This document, the software it describes, and the information and know-how they contain constitute the proprietary, confidential and valuable trade secret information of Alpha, and may not be used for any unauthorized purpose, or disclosed to others without the prior written permission of Alpha.

The material contained in this document is for information only and is subject to change without notice. While reasonable efforts have been made in the preparation of this document to assure its accuracy, Alpha assumes no liability resulting from errors or omissions in this document, or from the use of the information contained herein. Alpha reserves the right to make changes in the product design without reservation and without notification to its users.

# Contents

1. Safety.....	6
1.1 Safety symbols.....	6
1.2 General warning and cautions.....	6
1.3 Electrical safety.....	7
1.4 Battery safety.....	7
2. Introduction.....	8
2.1 Document scope.....	8
2.2 Product overview.....	8
2.3 System configurations.....	9
3. Specifications .....	13
3.1 Cordex® CXPS-E3 300 A edge power systems.....	13
3.2 Cordex® CXPS-E3 400 A edge power systems.....	14
3.3 Cordex® CXPS-E3 600 A edge power systems.....	16
3.4 Cordex® CXPS-E3 900 A edge power systems.....	17
4. Features .....	18
4.1 Seismic racks .....	18
4.2 Distribution panels.....	18
4.3 Control and monitoring methods .....	19
4.4 Front panel with controller and ADIO peripheral.....	21
4.5 Cordex® HP 2.4 kW rectifiers.....	24
4.6 Cordex® HP 3.0 kW rectifiers.....	24
4.7 Cordex® HP 4.0 kW rectifiers .....	24
4.8 Cordex® HP 4.6 kW rectifiers .....	24
4.9 Rectifier front panel LEDs .....	25
4.10 300 A and 400 A LVD override .....	26
4.11 600 A LVD override.....	28
4.12 Integrated battery trays .....	31
4.13 Battery landing busbar kit.....	31
5. Inspection .....	33
5.1 Packing materials.....	33



5.2	Returns for service .....	33
5.3	Check for damage .....	33
5.4	General receipt of shipment .....	33
5.5	Miscellaneous small parts .....	33
<b>6.</b>	<b>Installation.....</b>	<b>34</b>
6.1	Safety precautions .....	34
6.2	Tools required.....	34
6.3	Installation of external batteries .....	34
6.4	Battery maintenance report .....	36
6.5	Power system assembly and mounting .....	37
6.6	Breaker installation.....	39
<b>7.</b>	<b>Wiring.....</b>	<b>40</b>
7.1	Installation notes .....	40
7.2	Grounding .....	41
7.3	AC wiring.....	44
7.4	DC wiring.....	46
7.5	Distribution cabling.....	47
7.6	Alarm and signal connection .....	48
7.7	Network and remote communication .....	50
7.8	Connecting battery temperature sensor .....	50
7.9	Signal wiring .....	51
<b>8.</b>	<b>System startup .....</b>	<b>52</b>
<b>9.</b>	<b>Maintenance.....</b>	<b>54</b>
9.1	Controller lithium battery replacement.....	55
9.2	300 A and 400 A LVD override operation .....	56
9.3	600 A LVD override operation .....	56
<b>10.</b>	<b>Acronyms and definitions .....</b>	<b>57</b>

# Figures

Figure 1: Cordex® CXPS-E3 400 A edge power system (19-inch).....	8
Figure 2: Cordex® CXPS-E3 300 A edge power system (19-inch) with one 2.4/3.0 kW rectifier shelf .....	9
Figure 3: Cordex® CXPS-E3 300 A edge power system (23-inch) with one 2.4/3.0 kW rectifier shelf .....	10
Figure 4: Cordex® CXPS-E3 400 A edge power system (19-inch) with two 2.4/3.0 kW shelves .....	10
Figure 5: Cordex® CXPS-E3 400 A edge power system (23-inch) with two 2.4/3.0 kW shelves .....	10
Figure 6: Cordex® CXPS-E3 400 A edge power system (19-inch) with one 4.0/4.6 kW shelf.....	11
Figure 7: Cordex® CXPS-E3 400 A edge power system (23-inch) with one 4.0/4.6 kW shelf.....	11
Figure 8: Cordex® CXPS-E3 600 A edge power system (23-inch) with two 2.4/3.0 kW shelves .....	12
Figure 9: Cordex® CXPS-E3 900 A edge power system (23-inch) with three 2.4/3.0 kW shelves.....	12
Figure 10: Front panel with Cordex® CXC HP controller and Cordex® CXC HP L-ADIO peripheral.....	21
Figure 11: Cordex® CXC HP controller.....	21
Figure 12: Cordex® CXC HP L-ADIO smart peripheral.....	23
Figure 13: LVD override .....	26
Figure 14: LVD override interface.....	26
Figure 15: LVD override connections.....	27
Figure 16: Integrated battery tray .....	31
Figure 17: Battery landing busbar kit .....	32
Figure 18: Rack mounting details (top view), welded rack.....	38
Figure 19: Rack mounting details (top view), bolted rack.....	38
Figure 20: Breaker installation .....	39
Figure 21: Connecting the frame ground to the power system .....	42
Figure 22: Connecting the frame ground to overhead trays .....	42
Figure 23: AC input and ground for 23-inch shelf .....	45
Figure 24: Shelf AC connection (three-phase, three-wire shown with back cover removed).....	46
Figure 25: Alarm (relay) connections.....	48
Figure 26: Digital input connection method.....	49
Figure 27: Battery temperature sensor .....	50
Figure 28: Battery temperature sensor, battery bay .....	50
Figure 29: Relay connections, not energized state .....	51
Figure 30: Alarm relay pinouts .....	51
Figure 31: Controller battery replacement.....	55







# 1. Safety

## Save these instructions

This document contains important safety instructions that must be followed during the installation, servicing, and maintenance of the product. Keep it in a safe place. Review the drawings and illustrations contained in this document before proceeding. If there are any questions regarding the safe installation or operation of this product, contact Alpha Technologies Ltd. or the nearest Cordex® power system representative.

### 1.1 Safety symbols

To reduce the risk of injury or death, and to ensure the continued safe operation of this product, the following symbols have been placed throughout this document. Where these symbols appear, use extra care and attention.

Symbol	Type	Description
	<b>WARNING</b>	<b>Risk of serious injury or death</b> Equipment in operation poses a potential electrical hazard which could result in serious injury or death to personnel. This hazard may continue even when power is disconnected.
	<b>CAUTION</b>	Cautions indicate the potential for injury to personnel.
	<b>CAUTION</b>	<b>Risk of burns</b> A device in operation can reach temperature levels which could cause burns.
	<b>ATTENTION</b>	The use of attention indicates specific regulatory or code requirements that may affect the placement of equipment or installation procedures. Follow the prescribed procedures to avoid equipment damage or service interruption.
	<b>GROUNDING</b>	This symbol indicates the location or terminal intended for the connection to protective earth. An enclosure that is not properly connected to protective earth presents an electrical hazard. Only a licensed electrician can connect AC power and protective earth to the enclosure.
	<b>NOTICE</b>	A notice provides additional information to help complete a specific task or procedure or general information about the product.

### 1.2 General warning and cautions



#### **WARNING**

You must read and understand the following warnings before installing the enclosure and its component. Failure to do so could result in personal injury or death.

- Read and follow all instructions included in this document.
- Only trained personnel are qualified to install or replace this equipment and its components.
- Use proper lifting techniques whenever handling equipment, parts, or batteries.

## 1.3 Electrical safety



### WARNING

Hazardous voltages are present at the input of power systems. The DC output from rectifiers, though not dangerous in voltage, has a high short-circuit current capacity that can cause severe burns and electrical arcing.

The DC output from converters is a potentially hazardous voltage. Do not touch the output connections when under power. Ensure that power has been removed from the outputs before working on them.

Before working with any live battery or power system, follow these precautions:

- Remove all metallic jewelry, such as watches, rings, metal rimmed glasses, or necklaces.
- Wear safety glasses with side shields at all times during the installation.
- Use insulated hand tools. Do not rest tools on top of batteries.



### WARNING

Lethal voltages are present within the power system. Always assume that an electrical connection or conductor is energized. Check the circuit with a voltmeter with respect to the grounded portion of the enclosure (both AC and DC) before performing any installation or removal procedure.

- Do not work alone under hazardous conditions.
- A licensed electrician is required to install permanently wired equipment. Input voltages can range up to 480 Vac. Ensure the utility power is disconnected and locked out before performing any installation or removal procedure.
- Ensure that no liquids or wet clothes come into contact with internal components.
- Hazardous electrically live parts inside this unit are energized from the batteries even when the AC input power is disconnected.



### WARNING

#### High leak current

Earth connection is essential before connecting the supply.

## 1.4 Battery safety

- Servicing and connection of batteries must be performed by, or under the direct supervision of, personnel knowledgeable of batteries and the required safety precautions.
- Always wear eye protection, rubber gloves, and a protective vest when working near batteries. Remove all metallic objects from your hands and neck.
- Use OSHA approved insulated hand tools. Do not rest tools on top of batteries.
- Batteries contain or emit chemicals known to cause cancer and birth defects or other reproductive harm. Battery post terminals and related accessories contain lead and lead compounds. Wash your hands after handling batteries.



### WARNING

Follow the battery manufacturer's safety recommendations when working around battery systems. Do not smoke or introduce an open flame when batteries (especially vented batteries) are charging. When charging, batteries vent hydrogen gas, which can explode.

Batteries are hazardous to the environment and should be disposed at a recycling facility. Consult the battery manufacturer for recommended local authorized recyclers.

## 2. Introduction

---

### 2.1 Document scope

This document covers the features, options, installation, and startup of Cordex® CXPS-E3 edge power systems. Images contained in this document are for illustrative purposes only and may not exactly match your installation. To assist with installation, refer to the drawings at the end of this document.

In addition to this document, the following may be included in the documentation package that ships with Cordex® CXPS-E3 edge power systems:

- Cordex® CXC HP controller software manual (0350058-J0)
- Cordex® CXC HP controller and I/O peripherals hardware manual (0180036-J0)
- Cordex® HP 2.4/3.0 kW rectifier and shelf manual (0100037-J0)
- Cordex® HP 4.0/4.6 kW rectifier and shelf manual (9400000-J0)

### 2.2 Product overview

Cordex® CXPS-E3 edge power systems use high-density rectifiers, a front access distribution panel, and the advanced Cordex® CXC HP system controller. The power system is the ideal solution for small to medium-sized 48Vdc applications, providing up to 900 amps of output current. With universal 19-inch or 23-inch mounting, high temperature operation, and high power density, it is the perfect solution for a wide variety of installation scenarios including those in harsh, outdoor environments. The distribution panel provides up to 52 load breaker positions, integrated shunt, and optional low-voltage battery disconnect (LVBD). All distribution connections and controller I/O contacts are front accessible.

The Cordex® CXC HP controller includes a touchscreen display for simple and convenient local setup. A built-in web server provides alternate setup via local or remote IP access, using a standard internet browser. Cordex® CXPS-E3 edge power systems can be easily integrated into customer provided relay racks or enclosures, or can be ordered factory installed into various Alpha® relay rack configurations, including systems with pre-wired battery trays.

- Integrated 48V 300 A ,400 A, 600 A, or 900 A power systems with front access distribution
- Industry leading power system density
- Up to 900 A and 52 distribution positions
- Advanced Cordex® CXC HP controller with touchscreen display for full local control and a pre-wired Cordex® CXC HP L-ADIO analog and digital input and output (ADIO) smart peripheral.
- High temperature rated design for harsh outdoor applications
- Wide range AC input for flexible worldwide deployment



Figure 1: Cordex® CXPS-E3 400 A edge power system (19-inch)

## 2.3 System configurations

The following configurations are currently available for Cordex® CXPS-E3 edge power systems. For more ordering information, refer to the Cordex® CXPS-E3 Edge Power System Ordering Guide (0470209-00).

Rack size	Current rating	Rectifier capacity	Load breakers	Battery breakers	Shunt	LVBD	Height
19-inch	300 A	4 × 2.4/3.0 kW rectifiers (1 shelf)	21	0	Load		4RU
			16	5	Battery	Optional	4RU
23-inch	300 A	5 × 2.4/3.0 kW rectifiers (1 shelf)	21	0	Load		4RU
			16	5	Battery	Optional	4RU
19-inch	400 A	8 × 2.4/3.0 kW rectifiers (2 shelves)	21	0	Load		5RU
			16	5	Battery	Optional	5RU
19-inch	400 A	5 × 4.0/4.6 kW rectifiers (1 shelf)	21	0	Load		7RU
			16	5	Battery	Optional	7RU
23-inch	400 A	6 × 4.0/4.6 kW rectifiers (1 shelf)	26	0	Load		7RU
			21	5	Battery	Optional	7RU
23-inch	600 A	10 × 2.4/3.0 kW rectifiers (2 shelves)	26	0	Load		5RU
			26	0	Battery	Optional	5RU
23-inch	900 A	15 × 2.4/3.0 kW rectifiers (3 shelves)	52	0	Load × 2		11RU

### 2.3.1 300 A edge power systems (19-inch) with one 2.4/3.0 kW shelf

- Cordex® CXC HP system controller
- Cordex® CXC HP L-ADIO smart peripheral with extensive I/O capability
- Cordex® HP 2.4/3.0 kW shelf with up to four module positions; 4RU form factor
- **Current rating:** 300 A
- 21 load breakers with load shunt or 16 load and five battery breakers with LVBD
- Option for battery LVD for battery breaker configuration

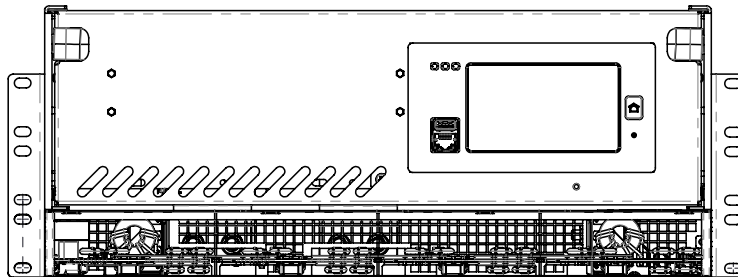

Figure 2: Cordex® CXPS-E3 300 A edge power system (19-inch) with one 2.4/3.0 kW rectifier shelf

### 2.3.2 300 A edge power systems (23-inch) with one 2.4/3.0 kW shelf

- Cordex® CXC HP system controller
- Cordex® CXC HP L-ADIO smart peripheral with extensive I/O capability
- Cordex® HP 2.4/3.0 kW shelf with up to five module positions; 4RU form factor
- **Current rating:** 300 A
- 21 load breakers with load shunt or 16 load and five battery breakers with LVBD
- Option for battery LVD for battery breaker configuration

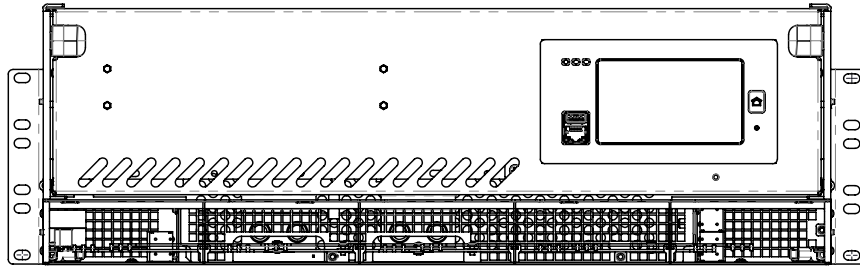

Figure 3: Cordex® CXPS-E3 300 A edge power system (23-inch) with one 2.4/3.0 kW rectifier shelf

### 2.3.3 400 A edge power systems (19-inch) with two 2.4/3.0 kW shelves

- Cordex® CXC HP system controller
- Cordex® CXC HP L-ADIO smart peripheral with extensive I/O capability
- Cordex® HP 2.4/3.0 kW shelves (two) with up to eight module positions; 5RU form factor
- **Current rating:** 400 A
- 21 load breakers with load shunt or 16 load and five battery breakers with LVBD
- Option for battery LVD for battery breaker configuration

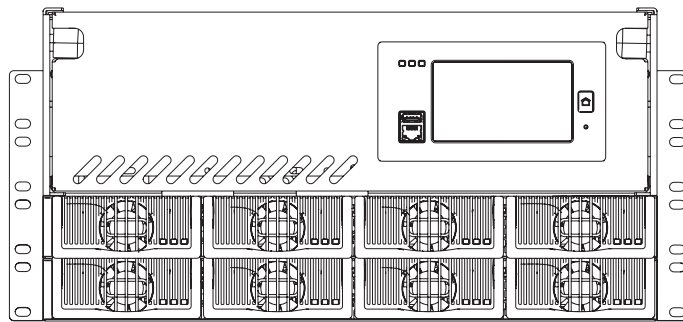

Figure 4: Cordex® CXPS-E3 400 A edge power system (19-inch) with two 2.4/3.0 kW shelves

### 2.3.4 400 A edge power systems (23-inch) with two 2.4/3.0 kW shelves

- Cordex® CXC HP system controller
- Cordex® CXC HP L-ADIO smart peripheral with extensive I/O capability
- Cordex® HP 2.4/3.0 kW shelves (two) with up to ten module positions; 5RU form factor
- **Current rating:** 400 A load
- 26 load breakers with load shunt or 21 load and five battery breakers with LVBD
- Option for LVBD for battery breaker configuration

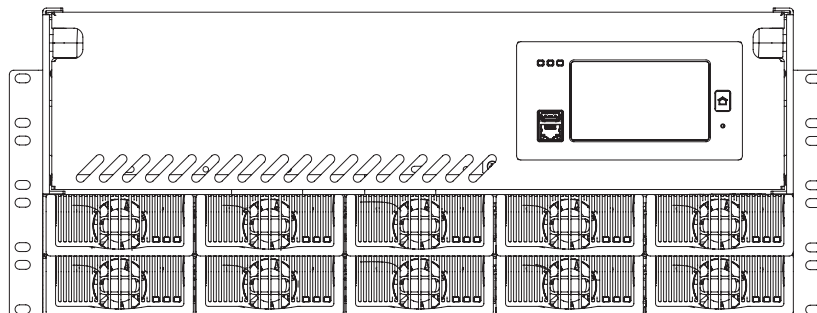

Figure 5: Cordex® CXPS-E3 400 A edge power system (23-inch) with two 2.4/3.0 kW shelves



### 2.3.5 400 A edge power systems (19-inch) with one 4.0/4.6 kW shelf

- Cordex® CXC HP system controller
- Cordex® CXC HP L-ADIO smart peripheral with extensive I/O capability
- Cordex® HP 4.0/4.6 kW shelf with up to five module positions; 7RU form factor
- **Current rating: 400 A**
- 21 load breakers with load shunt or 16 load and five battery breakers with LVBD
- Option for LVBD for battery breaker configuration

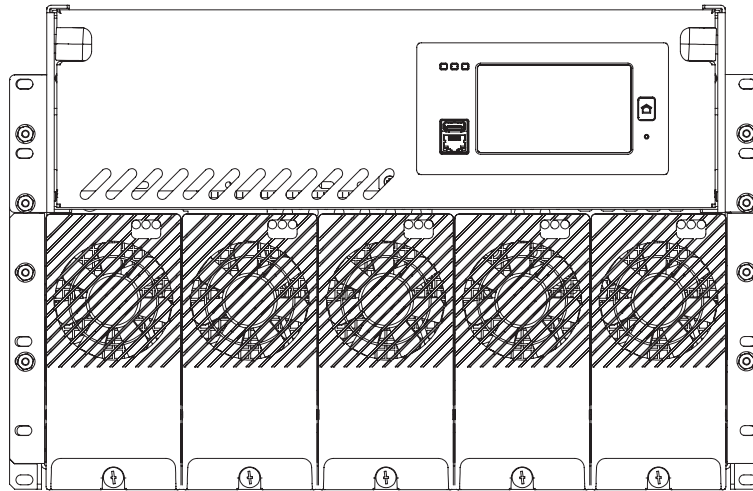

Figure 6: Cordex® CXPS-E3 400 A edge power system (19-inch) with one 4.0/4.6 kW shelf

### 2.3.6 400 A edge power systems (23-inch) with one 4.0/4.6 kW shelf

- Cordex® CXC HP system controller
- Cordex® CXC HP L-ADIO smart peripheral with extensive I/O capability
- Cordex® HP 4.0/4.6 kW shelf with up to six module positions; 7RU form factor
- **Current rating: 400 A**
- 26 load breakers with load shunt or 21 load and five battery breakers with battery LVD
- Option for battery LVD for battery breaker configuration
- Option for different AC input configurations individual feed, 208 three phase or 480/277 three phase

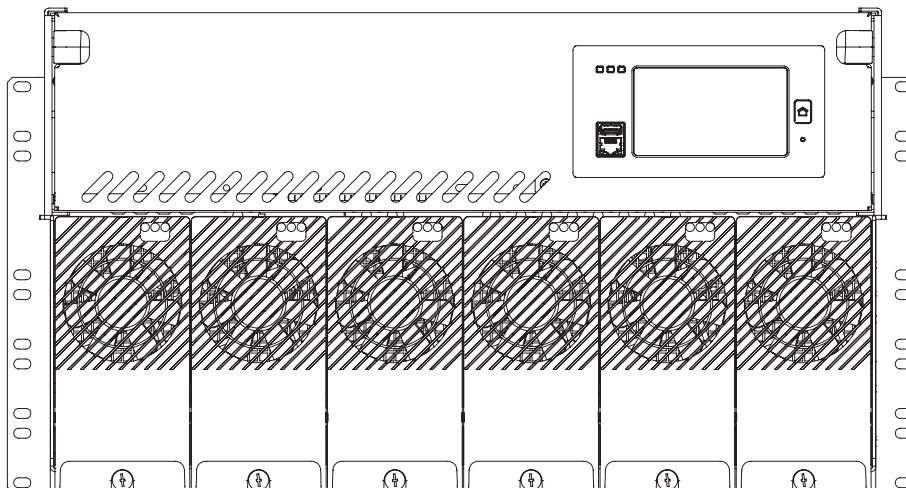

Figure 7: Cordex® CXPS-E3 400 A edge power system (23-inch) with one 4.0/4.6 kW shelf



### 2.3.7 600 A edge power systems (23-inch) with two 2.4/3.0 kW shelves

- Cordex® CXC HP system controller
- Cordex® CXC HP L-ADIO smart peripheral with extensive I/O capability
- Cordex® HP 2.4/3.0 kW shelves (two) with up to ten module positions; 5RU form factor
- **Current rating:** 600 A
- 26 load breakers with load shunt or 26 load breakers with battery shunt and battery LVD
- Choice of  $8 \times 35 \text{ mm}^2$  (2 AWG) battery landing busbars or  $2 \times 185 \text{ mm}^2$  (350 MCM) battery landing busbars

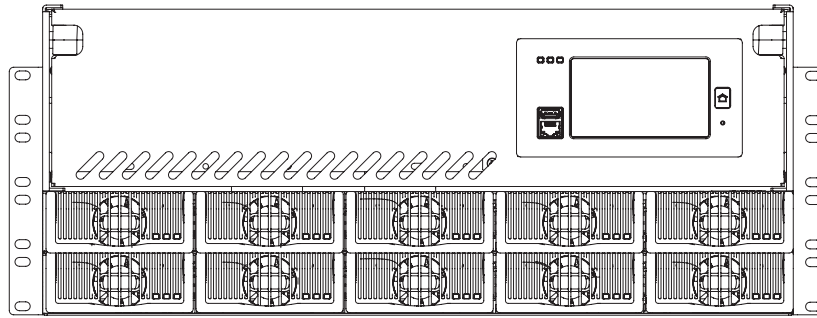

Figure 8: Cordex® CXPS-E3 600 A edge power system (23-inch) with two 2.4/3.0 kW shelves

### 2.3.8 900 A edge power systems (23-inch) with double distribution and three 2.4/3.0 kW shelves

- Cordex® CXC HP system controller
- Cordex® CXC HP L-ADIO smart peripheral with extensive I/O capability
- Cordex® HP 2.4/3.0 kW shelves (three) with up to 15 module positions; 11RU form factor
- **Current rating:** 900 A (450 A per distribution tier)
- 52 load breakers

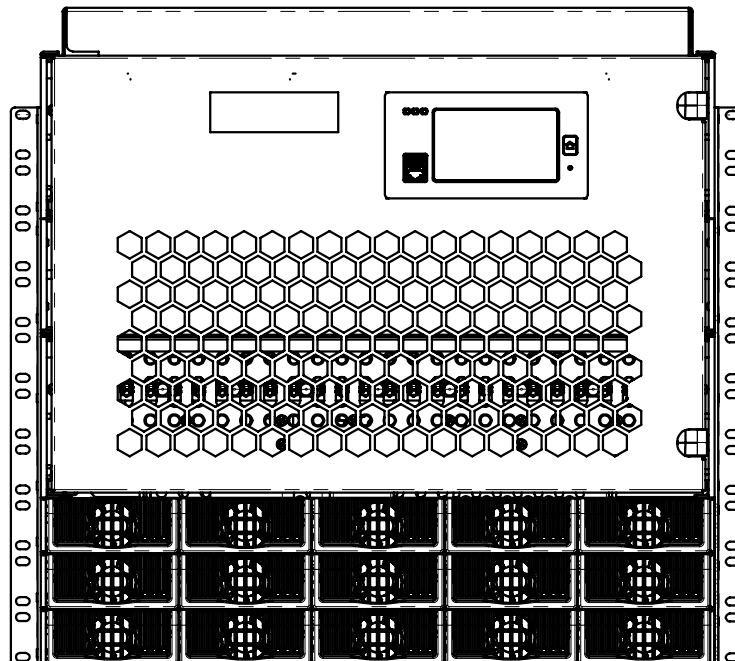

Figure 9: Cordex® CXPS-E3 900 A edge power system (23-inch) with three 2.4/3.0 kW shelves

## 3. Specifications

### 3.1 Cordex® CXPS-E3 300 A edge power systems

Table B — 48V–3.0 kW Cordex® CXPS-E3 300 A edge power systems

Electrical		
<b>48V-3.0 kW rectifier systems</b>		
<b>System capacity (maximum)</b>	300 A	
<b>Input</b>	<b>Operating voltage</b>	208 to 277Vac (nominal)
	<b>Extended (high)</b>	277 to 310Vac (derated O/P power)
	<b>Extended (low)</b>	90 to 187Vac (derated O/P power)
	<b>Recommended AC breakers</b>	19-inch systems: Up to 4 × 20 A feeds 23-inch systems: Up to 2 × 40 A feeds and 1 × 20 A feeds
	<b>Efficiency</b>	>96.5% peak efficiency
<b>Output</b>	<b>Current per module</b>	62.5 A at 48Vdc (nominal) 32 A max. at 48Vdc (120Vac)
	<b>Rectifier positions</b>	19-inch systems: Up to 4 rectifiers
		23-inch systems: Up to 5 rectifiers
Mechanical		
<b>19-inch systems</b>	<b>Mounting</b>	Flush or center mount
	<b>Dimensions (H × W × D)</b>	178 × 482 × 432 mm (7 × 19 × 17 in.)
	<b>Hot positions</b>	21 × load breakers <b>or</b> 16 load and 5 battery breakers
		21 × sets of 1/4 inch studs on 5/8 inch centers
	<b>Return positions</b>	21 × sets of 1/4 in. studs on 5/8 in. centers
<b>Weight (system)</b>	15.9 kg (35.1 lb)	
<b>23-inch systems</b>	<b>Mounting</b>	Flush or center mount
	<b>Dimensions (H × W × D)</b>	203 × 584.2 × 432 mm (8 × 23 × 17 in.)
	<b>Hot positions</b>	26 × load breakers <b>or</b> 21 load and 5 battery breakers
		26 × sets of 1/4 inch studs on 5/8 inch centers
	<b>Return positions</b>	26 × sets of 1/4 inch studs on 5/8 inch centers
<b>Weight (system)</b>	20.1 kg (44.4 lb)	
<b>Weight (rectifier)</b>	1.76 kg (3.9 lb) per module	
<b>System access</b>	Front access after initial installation	
<b>Controller</b>	Cordex® CXC HP controller	
Environmental		
<b>Temperature</b>	<b>Operation:</b> –40 to 55°C (–40 to 131°F) 55 to 65°C (–40 to 149°F) derated at (40°C) 104°F	
	<b>Storage:</b> –40 to 85°C (–40 to 185°F)	

<b>Relative humidity</b>	0 to 95% non-condensing
<b>Elevation</b>	Up to 2000 m (6600 ft)
	Up to 4000 m (13100 ft) with derated output
<b>Compliance</b>	
<b>Safety</b>	CSA C22.2 No. 60950-1-07
	UL 60950-1

### 3.2 Cordex® CXPS-E3 400 A edge power systems

Table C — 48V–2.4/3.0 kW, 4.0/4.6 kW Cordex® CXPS-E3 400 A edge power systems

<b>Electrical</b>			
		<b>48V-2.4/3.0 kW rectifier systems</b>	<b>48V-4.0/4.6 kW rectifier systems</b>
<b>System capacity (maximum)</b>		400 A	
<b>Input</b>	<b>Operating voltage</b>	208 to 277 Vac (nominal)	208 to 277 Vac
			Three-phase 208 to 240 Vac
			Three-phase 277/480 Vac
	<b>Extended (high)</b>	277 to 310 Vac (derated O/P power)	
	<b>Extended (low)</b>	90 to 187 Vac (derated O/P power)	
	<b>Recommended AC breakers</b>	19-inch systems: Up to 8 × 20 A feeds	19-inch systems: Up to 5 × 30 A feeds (208 to 277 Vac single phase)
	23-inch systems: Up to 4 × 40 A feeds and 2 × 20 A feeds	23-inch systems: Up to 6 × 30 A feeds (208 to 277 Vac single phase)	
		Up to 2 × 50 A feeds (208 Vac three-phase)	
		Up to 2 × 30 A feeds (480/277 Vac three-phase)	
<b>Efficiency</b>	>96.5% peak efficiency	>95% peak efficiency	
<b>Output</b>	<b>Current per module</b>	2.4 kW: 50 A at 48Vdc (nominal input) 25 A max. at 48Vdc (120 Vac)	4.0 kW: 83.3 A at 48Vdc (nominal input)
		3.0 kW: 62.5 A at 48Vdc (nominal) 32 A max. at 48Vdc (120 Vac)	4.6 kW: 95.8 A at 48Vdc (nominal input)
	<b>Rectifier positions</b>	19-inch systems: Up to 8 rectifiers	19-inch systems: Up to 5 rectifiers
		23-inch systems: Up to 10 rectifiers	23-inch systems: Up to 6 rectifiers

<b>Mechanical</b>			
		<b>48V-2.4/3.0 kW rectifier systems</b>	<b>48V-4.0/4.6 kW rectifier systems</b>
<b>19-inch systems</b>	<b>Mounting</b>	Flush or center mount	
	<b>Dimensions (H × W × D)</b>	222.1 × 482.6 × 442 mm (8.75 × 19 × 17.4 in.)	311 × 482.6 × 421.6 mm (12.25 × 19 × 16.6 in.)
	<b>Hot positions</b>	21 × load breakers <b>or</b> 16 load and 5 battery breakers	
		21 × sets of 1/4 inch studs on 5/8 inch centers	
	<b>Return positions</b>	21 × sets of 1/4 inch studs on 5/8 inch centers	
<b>Weight (system)</b>	20.4 kg (45 lb)	20 kg (44 lb)	
<b>23-inch systems</b>	<b>Mounting</b>	Flush or center mount	
	<b>Dimensions (H × W × D)</b>	222.1 × 544.2 × 442 mm (8.75 × 23 × 17.4 in.)	311 × 544.2 × 444.5 mm (12.25 × 23 × 17.5 in.)
	<b>Hot positions</b>	26 × load breakers <b>or</b> 21 load and 5 battery breakers	
		26 × sets of 1/4 inch studs on 5/8 inch centers	
	<b>Return positions</b>	26 × sets of 1/4 inch studs on 5/8 inch centers	
<b>Weight (system)</b>	25.8 kg (57 lb)	22.7 kg (50 lb)	
<b>Weight (rectifier)</b>	1.76 kg (3.9 lb) per module		3.9 kg (8.6 lb) per module
<b>System access</b>	Front access after initial installation		
<b>Controller</b>	Cordex® CXC HP controller		
<b>Environmental</b>			
<b>Temperature</b>	<b>Operation:</b> –40 to 55°C (–40 to 131°F) 55 to 65°C (–40 to 149°F) 4.6 kW derated at 40°C (104°F)		
	<b>Storage:</b> –40 to 85°C (–40 to 185°F)		
<b>Relative humidity</b>	0 to 95% non-condensing		
<b>Elevation</b>	Up to 2000 m (6600 ft)		
	Up to 4000 m (13100 ft) with derated output		
<b>Compliance</b>			
<b>Safety</b>	CSA C22.2 No. 60950-1-07		
	UL 60950-1		

### 3.3 Cordex® CXPS-E3 600 A edge power systems

Table D — 48V–3.0 kW Cordex® CXPS-E3 600 A edge power systems

<b>Electrical</b>		
<b>System capacity (maximum)</b>		
	<b>Systems with battery LVD</b>	<b>Systems without battery LVD</b>
<b>Amperage</b>	625 A total	625 A total
	550 A load	
	550 A battery	
<b>Input</b>	<b>Operating voltage</b>	208 to 277 Vac (nominal)
	<b>Extended (high)</b>	277 to 310 Vac (derated O/P power)
	<b>Extended (low)</b>	90 to 187 Vac (derated O/P power)
	<b>Recommended AC breakers</b>	Up to 4 × 40 A feeds and 2 × 20 A feeds
	<b>Efficiency</b>	>96.5% peak efficiency
<b>Output</b>	<b>Current per module (nominal input)</b>	62.5 A at 48 Vdc
		55.5 A at 54 Vdc
	<b>Rectifier positions</b>	Up to 10 rectifiers
<b>Mechanical</b>		
<b>Mounting</b>	Flush or center mount	
<b>Dimensions (H × W × D)</b>	256.5 × 544.2 × 495.3 mm (10.1 × 23 × 19.5 in.)	
<b>Hot positions</b>	26 × load breakers 26 × sets of 1/4 inch studs on 5/8 inch centers	
<b>Return positions</b>	26 × sets of 1/4 inch studs on 5/8 inch centers	
<b>Weight (system)</b>	27.2 kg (60 lb)	
<b>Weight (rectifier)</b>	1.76 kg (3.88 lb) per module	
<b>System access</b>	Front access after initial installation	
<b>Controller</b>	Cordex® CXC HP controller	
<b>Environmental</b>		
<b>Temperature</b>	<b>Operation:</b> –40 to 55°C (–40 to 131°F) 55 to 65°C (–40 to 149°F) derated output	
	<b>Storage:</b> –40 to 85°C (–40 to 185°F)	
<b>Relative humidity</b>	0 to 95% non-condensing	
<b>Elevation</b>	Up to 2000 m (6600 ft)	
<b>Compliance</b>		
<b>Safety</b>	CSA C22.2 No. 60950-1-07	
	UL 60950-1	

### 3.4 Cordex® CXPS-E3 900 A edge power systems

Table E — 48V–2.4/3.0 kW Cordex® CXPS-E3 900 A edge power systems

<b>Electrical</b>			
		<b>48V-2.4 kW rectifier systems</b>	<b>48V-3.0 kW rectifier systems</b>
<b>System capacity (maximum)</b>			
<b>Amperage</b>		750 A load total	900 A load total
		450 A maximum per tier	450 A maximum per tier
<b>Input</b>	<b>Operating voltage</b>	208 to 277Vac (nominal)	
	<b>Extended (high)</b>	277 to 310Vac (derated O/P power)	
	<b>Extended (low)</b>	90 to 187Vac (derated O/P power)	
	<b>Recommended AC breakers</b>	Up to 6 × 40 A feeds and 3 × 20 A feeds	
	<b>Efficiency</b>	>96.2% peak efficiency	>96.5% peak efficiency
<b>Output</b>	<b>Current</b>	900 A max.	
	<b>Current per module (nominal input)</b>	50 A at 48Vdc	62.5 A at 48Vdc
		44.4 A at 54Vdc	55.5 A at 54Vdc
	<b>Rectifier positions</b>	Up to 15 rectifiers	
<b>Mechanical</b>			
<b>Mounting</b>		Flush or center mount	
<b>Dimensions (H × W × D)</b>		489 × 685 × 533 mm (19.25 × 23 × 21 in.)	
<b>Rack space</b>		11 RU	
<b>Breaker positions</b>		52 × load breaker positions	
<b>Hot (load) positions</b>		52 × sets of 1/4 inch studs on 5/8 inch centers	
<b>Return positions</b>		52 × sets of 1/4 inch studs on 5/8 inch centers	
<b>Weight (system)</b>		38.7 kg (85 lb)	
<b>Weight (rectifier)</b>		1.83 kg (4.04 lb) per module	
<b>System access</b>		Front access after initial installation	
<b>Environmental</b>			
<b>Temperature</b>		<b>Operation:</b> –40 to 55°C (–40 to 131°F)	
		<b>Storage:</b> –40 to 85°C (–40 to 185°F)	
<b>Relative humidity</b>		0 to 95% non-condensing	
<b>Elevation</b>		Up to 2800 m (9186 ft)	
<b>Cooling</b>		Fan-cooled (front to rear)	
<b>Heat dissipation</b>		171 W (585 BTU/h) per module max.	
<b>Compliance</b>			
<b>Safety</b>		CSA/UL 62368-1 Edition 2	

## 4. Features

---

### 4.1 Seismic racks

Cordex® CXPS-E3 edge power systems can be installed in a variety of Alpha® 19-inch and 23-inch seismic racks. These racks have been Z4 rated and NEBS L3 certified. The racks vary in their Z4 seismic capabilities from 227 to 1134 kg (500 to 2500 lb) and 3.5 to 9 feet in height (standard 7 foot racks are available as well). For more ordering information, refer to the Cordex® CXPS-E3 edge power system Ordering Guide (0470209-00) on the Alpha® website.

19-inch or 23-inch seismic rack

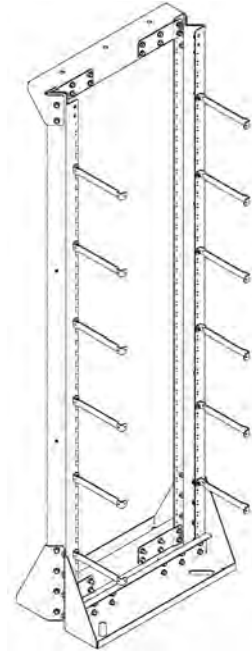

### 4.2 Distribution panels

Cordex® CXPS-E3 edge power systems have been designed with high density breaker or fuse count for use in 48V applications and is rated for a total ampacity of 300A, 400A, 600A, or 900A. It is available either in a 19-inch or 23-inch configuration. All systems include a back top cover for the protection of live customer connections.

#### 4.2.1 300 A and 400 A 19-inch distribution panels

Provides up to 21 breakers which can be configured as all load breakers (21 load breakers) or a mix of load and battery breakers (16 load breakers and five battery breakers).

The all load breaker configurations have a shunt that monitors the total load current supplied by the rectifiers to the load.

Both load and battery hot and return connections are made on 1/4 inch studs on 5/8 inch centers using narrow tongue lugs. Adapter kits for landing larger cables are available when higher capacity two or three pole breakers are required.

### 4.2.2 300 A and 400 A 23-inch distribution panels

Provides up to 26 breakers which can be configured as all load breakers (26 load breakers) or a mix of load and battery breakers (21 load breakers and five battery breakers).

The all load breaker configuration has a shunt that monitors the total load current supplied by the rectifiers to the load.

The load and battery configuration has a shunt that monitors the total battery charge and discharge current and includes a battery low voltage battery disconnect (battery LVD).

Both the hot and return connections are made on 1/4 inch studs on 5/8 inch centers using narrow tongue lugs. Adapter kits for landing larger cables are available when higher capacity two or three pole breakers are required.

### 4.2.3 600 A 23-inch distribution panel

Provides up to 26 load breakers with configurable battery landing outputs. The all load breaker configuration has a shunt that monitors the total load current supplied by the rectifiers to the load. The low voltage battery disconnect configuration has a shunt that monitors the total battery charge and discharge current and includes a battery low voltage disconnect (battery LVD).

Both the hot and return connections are made on 1/4 inch studs on 5/8 inch centers using narrow tongue lugs. Adapter kits for landing larger cables are available when higher capacity two or three pole breakers are required.

Two battery landing busbar options are available for the 600 A 23-inch distribution panel:

- 8 × 35 mm<sup>2</sup> (2 AWG) battery landings
- 2 × 185 mm<sup>2</sup> (350 MCM) battery landings

### 4.2.4 900 A 23-inch distribution panel

Provides up to 52 load breakers with extensive battery landing outputs. This configuration has two 26 position distribution sections with separate load current and breaker sensing. The total load current and overall breaker status is available from the controller interface providing both flexibility and simplicity. Both the hot and return connections are made on 1/4 inch studs on 5/8 inch centers using narrow tongue lugs. Adapter kits for landing larger cables are available when higher capacity two or three pole breakers are required. Convenient battery landings allow wiring from side, above, or below, and per polarity have capacity for ten each of 1/4 inch studs on 5/8 inch spacing for 35 mm<sup>2</sup> (2 AWG) wire, or two each 3/8 inch studs on 1 inch spacing for 96 mm<sup>2</sup> (3/0 AWG) cables.

## 4.3 Control and monitoring methods

The power system front panel provides inputs and outputs for load and battery voltage, battery or load current, breaker alarms and disconnect control as well as monitoring. Additional I/O (expansion) is available for customer use. See the following table for the details.

Table F — Control and monitoring methods	
Features	
<b>Cordex® CXC HP L-ADIO smart peripheral</b>	
<b>Dedicated I/O:</b>	<ul style="list-style-type: none"> <li>• Bus voltage monitoring (2)</li> <li>• Breaker alarm monitoring (2)</li> <li>• Dry contact– breaker alarm (2)</li> <li>• Bus voltage sense (2)</li> </ul>
<b>Expansion I/O (customer use):</b>	<ul style="list-style-type: none"> <li>• Temperature sensor inputs (4)</li> <li>• Form C relay outputs (12)</li> <li>• Digital inputs (6)</li> <li>• Voltage sense inputs (2)</li> <li>• Current shunt inputs (4)</li> </ul>



<b>Cordex® CXC HP controller</b>	
	<ul style="list-style-type: none"><li>• Local connection to the Cordex® CXC HP L-ADIO peripheral</li><li>• Advanced user interface</li><li>• Ethernet connection</li></ul>

### 4.3.1 Breaker labelling

For systems with load only outputs, the numbering goes from left (1) to right (21 for 19-inch systems or 26 for 23-inch systems). For systems with batteries and loads, the load numbering goes from left (1) to center/right (16 for 19-inch systems or 21 for 23-inch systems) and the battery labelling goes from right (1) to left (5).

There is a label on top of the front door which can be seen from the top when the door is closed, and from the front when the door is open. This label is larger and suitable for writing information about the breaker position.

There are two additional labels for breaker identification: a thin label above the breaker which can be read from the front (not writable), and one on the back/top near the return breakers which identify the positions of the return (not writable).

## 4.4 Front panel with controller and ADIO peripheral

The front panel includes the Cordex® CXC HP controller and a pre-wired Cordex® CXC HP L-ADIO smart peripheral.

The Cordex® HP family of products provide centralized setup, control, and monitoring of power systems. This can range from simple monitoring and threshold alarms for temperature, voltage and current, to advanced battery charging and diagnostic features. The controller has a 4.3-inch, full color touchscreen display. The controller provides dual Ethernet ports allowing for simultaneous network, LCD and local laptop access to the controller including both web and SNMP interfaces.

The controller supports dual CAN ports to allow up to 254 power or ADIO modules to be controlled and monitored. The controller uses external ADIO peripherals to monitor electrical signals (for example temperature and voltage) and generate electrical signals through relays.

The most commonly used ADIO smart peripheral is the Cordex® CXC HP L-ADIO for low voltage systems which includes:

- 8 digital inputs
- 4 voltage sensors
- 4 temperature sensors
- 4 current sensors
- 12 Form C relay outputs

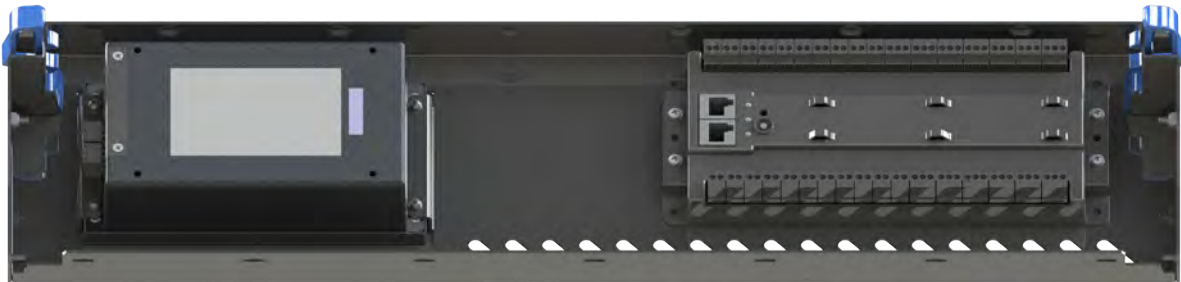

Figure 10: Front panel with Cordex® CXC HP controller and Cordex® CXC HP L-ADIO peripheral

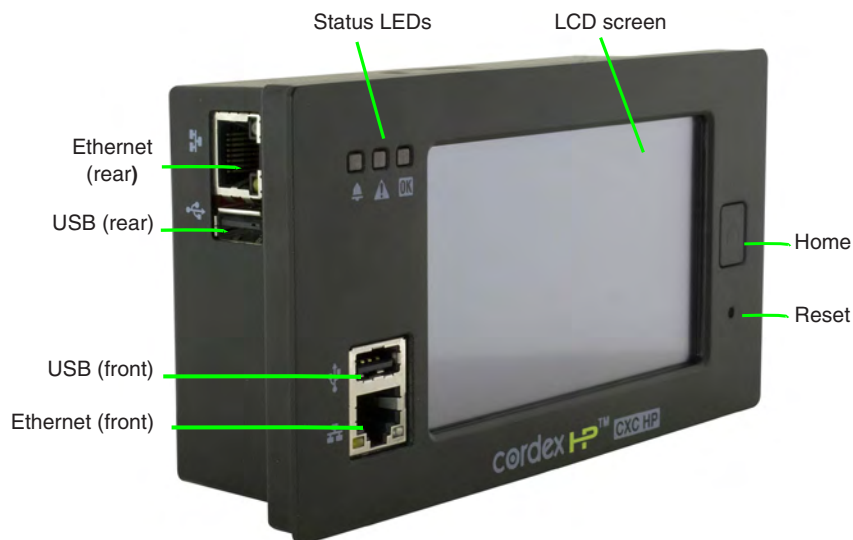

Figure 11: Cordex® CXC HP controller

The Cordex® CXC HP controller has the following features:

<b>Front touchscreen</b>	Full color touchscreen LCD, to access controls and menu items by using touch or a stylus.
<b>Home button</b>	Provides the ability to go directly back to the home screen from any menu.
<b>Front panel reset</b>	For emergency use only to restart the controller if the unit touchscreen or home button are not responding.
<b>Front panel LEDs</b>	For alarms, progress and status indication.
<b>Audio speaker</b>	Built-in audio speaker tones during active alarms and can be disabled if required.
<b>Dual Ethernet ports</b>	10/100 BASE-T Ethernet connection on both the front and back of the controller for remote or local communication.
<b>USB</b>	Dual ports on both the front and back of the controller for upgrades or file management via a standard USB drive.
<b>CAN</b>	Dual independent CAN bus ports for communication with the Cordex® HP and AMPS family of products, allowing for a greater number of devices.
<b>Real-time clock</b>	With field replaceable lithium battery, allows for timestamps on alarms and events.
<b>System fail alarm/relay</b>	Which activates when there is a major internal failure. During such a condition the unit attempts to reset.

#### 4.4.1 Cordex® CXC HP L-ADIO smart peripheral

##### Analog input channels

The peripheral is supplied with analog input channels for voltage, current, and temperature.

##### Voltage inputs

Two voltage input channels, V1 and V2, are used to monitor the discharge and charge voltage. V1 for **Bus A Voltage** and V2 for **Bus B Voltage**. Voltage inputs V3 and V4 are not used in power systems and are available for customer use.

##### Temperature inputs

The peripheral can accept up to four temperature probes to monitor the surrounding ambient temperatures. These analog values can be used to report high or low temperature alarms.

##### Digital input channels

The peripheral can accept up to eight digital inputs. Digital inputs D1 and D2 are wired for **Bus 'A' Breaker Alarm** and **Bus 'B' Breaker Alarm** respectively. Digital inputs D3 to D8 are available for customer use.

##### Alarm and control output relays

The peripheral contains 12 Form C digital alarm output relays, that are used to extend alarms and control to external apparatus. Each internally generated alarm or control signal may be mapped to any one of these relays, or several signals may be mapped to just one relay or none at all. Some of the output relays are pre-configured for LVD control if equipped (K1, K5, or K6), minor alarm (K10), major alarm (K11), and critical alarm (K12).

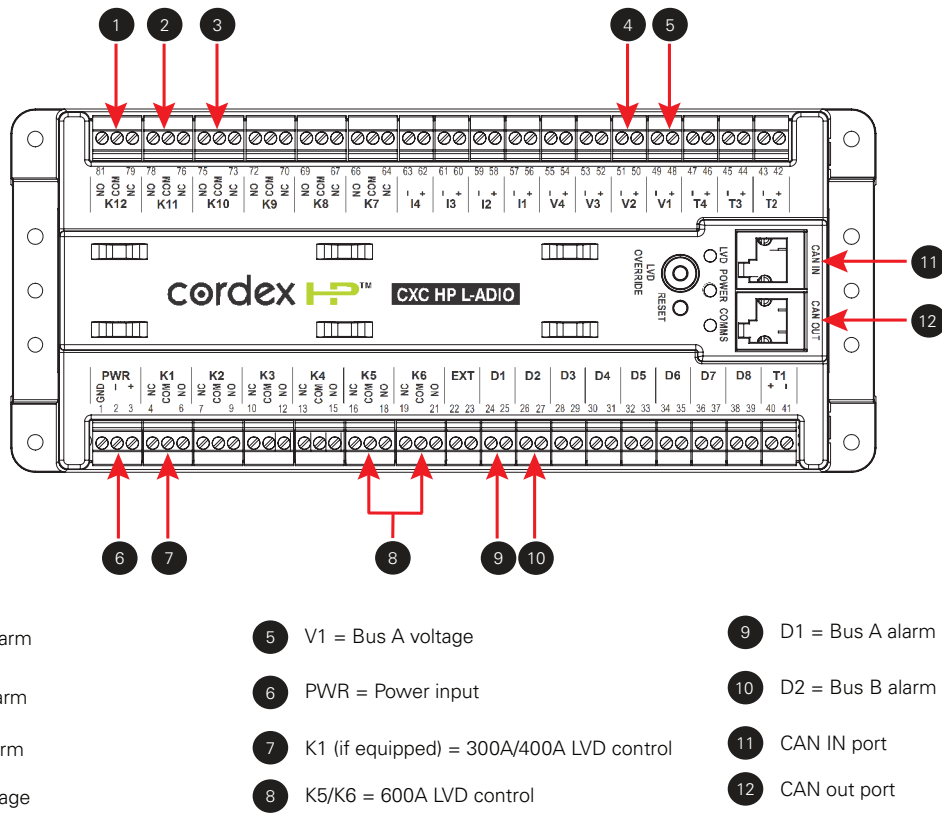

Figure 12: Cordex® CXC HP L-ADIO smart peripheral

### Network connection and remote communications

The system can be set up, monitored, and tested via an Ethernet IEEE 10/100 BASE-T serial data connection. The communication protocol supports a web interface. A CAN bus is used to transmit all alarm and control functions between the controller and rectifiers.

Refer to Cordex® CXC HP System Controller Software Manual (User Guide ID: 0350058-J0) for operation of controller.

### Front panel wiring notes

The terminal blocks on the indicator boards are suitable for 0.14 to 1.5 mm<sup>2</sup> (26 to 16 AWG) wire. As both signals are low current, it is recommend to use thinner wire where possible to make routing easier and to minimize space consumed by in the system. This is especially important with the Cordex® CXC HP L-ADIO peripheral if many of the expansion I/O capabilities are to be used.

Added wiring should be routed along the same path as the bus connection cable and then extend through the back of the unit. Take care to restrain the wiring sufficiently while providing enough slack so as not to interfere with operation of the door. Use the cable tie locations on the Cordex® CXC HP L-ADIO peripheral to restrain the cables within the front panel, and use the lance features on the chassis side panels to guide the cabling to the back of the unit.

## 4.5 Cordex® HP 2.4 kW rectifiers

### 4.5.1 Rectifier features

- High performance compact 50 A rectifier for 48 Vdc telecom applications
- High efficiency (>96.2 percent) for reduced OPEX and carbon footprint
- High temperature operating range for installation in non-controlled environments
- Multiple configurations providing up to 250 A or 12 kW in a compact 1RU form factor
- High power density (28 W/in<sup>3</sup>) yields more space for revenue generating equipment
- Wide AC input operating range for global installation requirements
- Extended operating temperature range up to 75°C (176°F) for deployment in the harshest outdoor environments

## 4.6 Cordex® HP 3.0 kW rectifiers

### 4.6.1 Rectifier features

- High performance compact 62.5 A rectifier for 48 Vdc telecom applications
- High efficiency (>96.5 percent) for reduced OPEX and carbon footprint
- High temperature operating range for installation in non-controlled environments
- Multiple configurations providing up to 312.5 A or 15 kW in a compact 1RU form factor
- High power density (35 W/in<sup>3</sup>) yields more space for revenue generating equipment
- Wide AC input operating range for global installation requirements
- Extended operating temperature range up to 75°C (176°F) for deployment in the harshest outdoor environments

## 4.7 Cordex® HP 4.0 kW rectifiers

### 4.7.1 Rectifier features

- High performance 83.3 A rectifier for 48 V telecom applications
- 95 percent efficiency for increased OPEX savings and reduced carbon footprint
- High power density 4RU compact form factor delivering up to 24 kW per 23-inch shelf
- Power limiting and wide range AC input for global installation requirements
- Extended operating temperature range up to 75°C (176°F) for deployment in the harshest outdoor environments



## 4.8 Cordex® HP 4.6 kW rectifiers

### 4.8.1 Rectifier features

- High performance 95.8 A rectifier for 48 V telecom applications
- 95 percent efficiency for increased OPEX savings and reduced carbon footprint
- High power density 4RU compact form factor delivering up to 27.6 kW per 23-inch shelf
- Power limiting and wide range AC input for global installation requirements
- Extended operating temperature range up to 75°C (176°F) for deployment in the harshest outdoor environments

## 4.9 Rectifier front panel LEDs

The front panel LEDs indicate the rectifier status summary and patterned response to **Locate Module** command.

	<b>Alarm/fault</b>	<p>The red LED is on during an active <b>Module Fail</b> alarm if the module is unable to source power due to a fault condition. Refer to the controller manual for fault details.</p> <p>The LED flashes (~2Hz) when a minor alarm is detected if the module's output capability has been reduced or a minor failure is detected.</p> <p>The red LED will remain active if the module is receiving power from the DC bus.</p>
	<b>DC output voltage</b>	<p>The green LED is on when the rectifier is delivering power to the load. The LED goes out when the rectifier is off. For example, when commanded by the controller.</p>
	<b>AC input voltage</b>	<p>The green LED is on when the AC input voltage is qualified and within the operational AC input range and input frequency.</p>

## 4.10 300 A and 400 A LVD override

For systems with LVD, an override interface is provided, see [Figure 13](#). This interface board includes three LEDs to provide visual status indication, and two customer connections for remote control and monitoring:

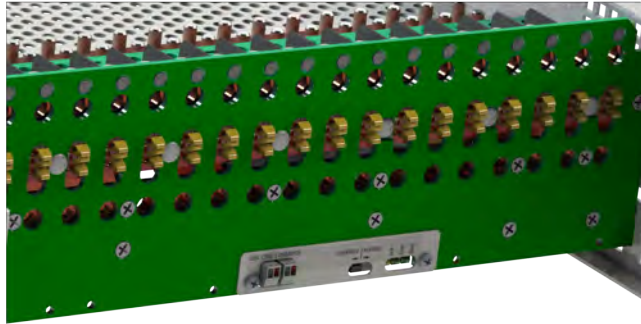

Figure 13: LVD override

### LEDs

- **BUS (green):** Lit when the bus connected to the LVD has power connected.
- **COIL (green):** Lit when the LVD coil is energized. This requires the bus to have power and one of the controls (L-ADIO, REMOTE, or LVD Override) to be active
- **O/R (yellow):** Lit when the override switch is in the override position. This should only be on during maintenance.

### Connections

- **VERRIDE:** 48V/5 mA signal, active when override switch is in override position.
- **COIL CTRL:** Control input for LVBD coil, can be configured for remote control or remote disable: When configured for remote control (default), a dry contact connected to the coil control input can turn on the LVBD independently of the LVD or the automatic control.
- When configured for remote disable, the coil control input must be shorted by a dry contact for either the automatic control or the LVD override to operate.

The LVD override interface is configured for remote control by default for most systems.



Figure 14: LVD override interface

**To change configuration:**

This operation must be done with AC and DC power disconnected, ideally prior to commissioning the system.

1. Remove the interface from the power system by removing the two screws from the front.
2. Lower the board, and pull it forward through the opening.
3. Flip the board over, and observe the jumper on the bottom of the board.
4. Move the jumper to the desired position:
  - CTRL (NO) position: the COIL CTRL is configured for remote control.
  - ENBL (NC), COIL CTRL for remote enable.
5. After the jumper is set check all cable connections (in case they were pulled loose when the board was removed).
6. Reinstall the board and labels using the original screws.

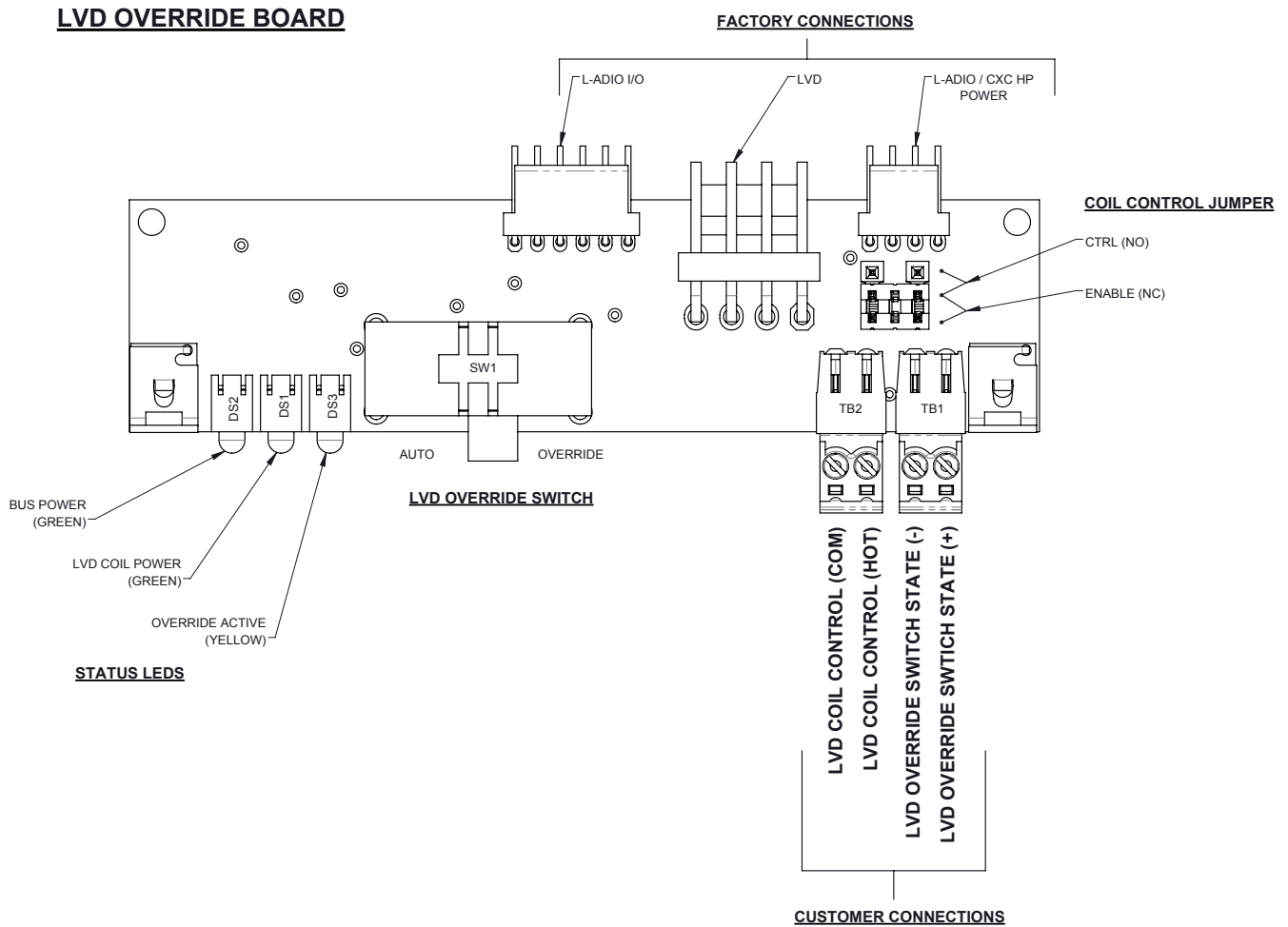

Figure 15: LVD override connections



## 4.11 600 A LVD override

### 4.11.1 Introduction

Contactors are mechanical switches, which connect and disconnect high current power sources and electrical load, for example between rectifiers and batteries or loads in a power system. The 600 A edge power system takes advantage of the higher efficiency and smaller form factor of a latching contactor, along with heavier bus work, to enable a much higher current rating than 400 A edge power systems in the same physical volume. For example, when combined with 3.0 kW rectifiers it has a rating of 625 A compared to 450 A for 400 A edge power systems with 2.4 kW rectifiers. To safely and reliably control the latching contactor, 600 A edge power systems have a different LVD interface board than 400 A edge power systems. While 400 A edge power systems has an LVD override board, which enabled service to force the LVD on even if the controller was removed, 600 A edge power systems have an LVD control interface (LCI) which buffers the ADIO peripheral control signals for the higher coil current and enables manual operation.

Traditionally the Telecom industry has used non-latching contactors which have a simple operation: when power is provided to the contactor it closes and maintains closure (connecting two points electrically); if power is removed the contactor automatically opens. The advantage of these contactors is that if power is lost to the contactor they simply open, so called fail-safe operation, but the disadvantages are continuous heat losses in driving the coil closed and higher losses in the electrical contacts.

A latching contactor has a strong permanent magnet capable of holding the contacts closed and only a short pulse of current is needed to close it initially. Because coil operation is only temporary a much higher current can be allowed without concern of overheating, and this allows the closing force to be higher. The result is lower electrical losses in both the actuating coil and the load connections, overall providing a more compact and efficient design. The added complexity makes these contactors a little more expensive, but the more significant difference is that if power fails they do not automatically open. Depending on the application this might be viewed as an advantage or disadvantage; the inherent fail-safe operation is lost, but it is also less likely to unexpectedly drop a load by opening due to controller failure.

### 4.11.2 Normal operation

#### Standard function

In an 600 A edge power system, the latching contactor is used as a low voltage battery disconnect (LVBD) between a bulk feed input and the main bus where the load breakers connect. During normal operation the LVBD is closed, the battery bank is connected to the main bus, and the batteries are charging. The user will have to set a minimum voltage threshold, below which the batteries might be damaged if discharged. The user will also have to set a reconnection voltage above which the batteries should reconnect to the main bus. As per standard practice the reconnect voltage is above the battery open circuit voltage so it will not reconnect until AC power returns. From this state the controller will use two control relays on the ADIO peripheral to control the contactor state as described.

Upon AC power failure, the batteries discharge to support the critical load. If the main voltage falls below the threshold where the batteries may be permanently damaged, the controller opens the latching LVBD by energizing a relay on the ADIO peripheral, which is connected to the Latching Interface board. When the LVBD opens the batteries disconnect, and within a few seconds the controller loses power and turns off and the control relay on the ADIO peripheral is disabled.

Upon return of AC power if the batteries are disconnected, the rectifiers turn on and provide power to the load. Once the main bus voltage exceeds the reconnect threshold, the controller closes the LVBD by energizing a relay on the ADIO peripheral (different than the one that is used to open the contactor). This connects the batteries to the main bus and returns the system to a normal operating state.

## Fault recovery and alarms

The controller monitors the state of the LVBD through a digital input on the ADIO peripheral board. If the controller detects that the LVBD state is not as expected (closed when expected to be open or open when expected to be closed), it attempts to correct this by energizing the appropriate control relays. For example, if a service person opens the contactor using the manual controls (refer to **Service operation**) then the controller attempts to reclose it within two to three seconds.

In the case where the state remains incorrect the controller attempts to correct it up to three consecutive times. After those three attempts it generates a user alarm and waits 15 minutes before trying again. This overall cycle of three attempts followed by a 15 minute pause continues until the contactor changes state, is disabled, or serviced.

## Contactor state

The contactor state is monitored through the ADIO peripheral on **Digital Input D3**. This can be seen on the controller display or through the web interface.

## Battery not present

The LVD control interface (LCI) uses power from the battery side to drive the contactor coil. Therefore if a battery is not connected the contactor does not operate. Operation without a battery is described in the service section.

### 4.11.3 Service operation

The LVD interface board provides two manual control buttons for service use: close and open. To operate the contactor a pulse of current is sent to the contactor and for each of the operations there is a yellow LED and a push button switch. Each yellow LED turns on when and if the pulse generator is charged for the respective operation, that is, when it is ready.

Close		Open		Control power
RDY (YELLOW LED)	CTRL (SWITCH)	RDY (YELLOW LED)	CTRL (SWITCH)	(GREEN LED)

Note that the pulse generator charges through the **Normally Closed** terminal of the associated relay on the ADIO peripheral. Therefore the associated control wiring must be plugged into the ADIO peripheral for the manual operation to work, specifically K6 for close and K5 for open. This feature can be used to disable the controller so that it cannot override manual operation; the specific options and operations are as follows:

## Operation

1. Disable the LVD: From the controller go to **Systems > DC System > Inventory > Disconnects**.
2. Push the button to put the LVD in the desired state.
3. Unplug K5/K6 (optional).
4. Perform maintenance work.
5. Plug in K5/K6 if unplugged in step 3.
6. Push the button to put the LVD in the desired state (optional).
7. Enable the LVD: From the controller go to **Systems > DC System > Inventory > Disconnects**.

Operation	K5	K6	Action
Close contactor but allow controller to re-open	Any	Plugged in	Select <b>Closed</b>
Open contactor but allow controller to re-close	Plugged in	Any	Select <b>Open</b>
Close contactor and prevent controller from re-opening	Unplugged	Plugged in	Select <b>Closed</b>
Open contactor and prevent controller from re-opening	Plugged in	Unplugged	Select <b>Open</b>

**NOTICE**

**If the controller is non-functioning, this table can be used for operation of the LVD.**

### Control power LED

The latching interface board also performs the ancillary function of combining the battery and rectifier outputs for the controller and ADIO control devices so they are powered when either source is present. The control power LED simply provides the status that either one of these sources is present.

### Latching interface background

The LVD control interface (LCI) translates the ADIO peripheral control relay state change into a fixed duration high current pulse to the contactor, thus preventing the contactor coil from being continuously powered in case of operator or controller error. It does this by charging a capacitor in the pulse generator when a control relay is off, and then discharging it when the control relay is on. Therefore, it is necessary to have the control relay off for a short time period (<1 second) between actuation attempts. This recharging is done through the **Normally Closed** contacts of the control relay on the ADIO peripheral.

### Troubleshooting

Symptom	Possible cause
Manual operation does not work	Check if related LED is illuminated, if not check the ADIO peripheral connection.
Contactor closes after manual opening	Check controller function, is it reconnecting due to high battery voltage? If so unplug K6.
Contactor opens after manual closing	Check controller function, is it disconnecting due to low battery voltage? If so unplug K5.
Contactor won't operate and the green LED on LCI board is not illuminated	Check if battery or rectifier output is live.
Contactor won't operate but the green LED on LCI board is illuminated	Check if the battery is disconnected. (If the rectifier output is live the load bus will power the green LED.)

## 4.12 Integrated battery trays

Cordex® CXPS-E3 edge power systems are designed to integrate battery trays below the power system. These battery trays can accept standard 12 volt mono-blocks ranging in height from 6RU to 8RU. The battery trays are factory installed and pre-wired for ease of installation. They can be configured with or without battery breakers as over current protection devices (OCPD). The battery breakers are installed within a breaker housing on the side of each battery tray. The breaker sizes and its associated cabling can range from 100 A to 250 A.

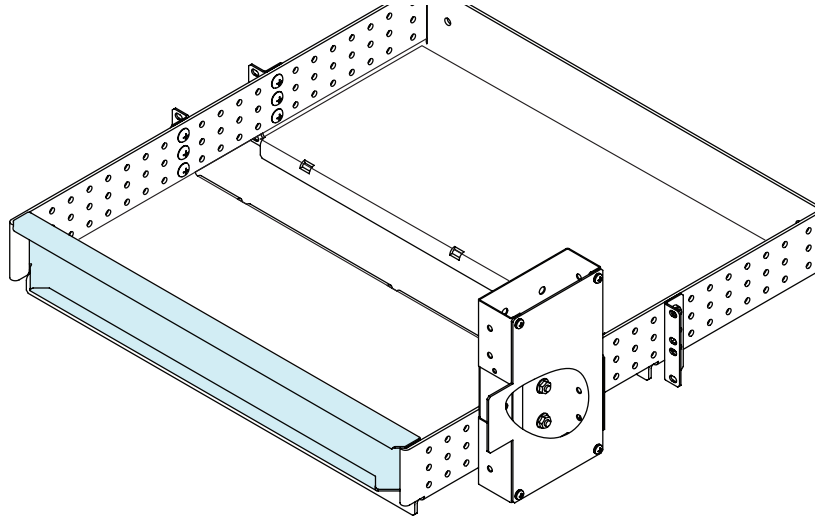

Figure 16: Integrated battery tray

When battery trays are ordered for systems without a low voltage battery disconnect (LVBD), the battery cable landing busbar kit will need to be ordered. This kit provides a secure location to terminate each individual battery tray cable to the main power system bus enabling a neat and clean install. In addition, this kit provides sufficient access to customers in the event that a battery tray and its associated cabling needs to be added in the field on a live plant.

## 4.13 Battery landing busbar kit

### 4.13.1 300 A edge power system battery landing busbar kit

Cordex® CXPS-E3 300 A edge power systems can be purchased with an optional battery landing busbar kit (PN: 0250030-550) which provides landing locations for three pairs of back-to-back cable lugs. This kit is customer installed at time of system installation.

### 4.13.2 400 A edge power system battery landing busbar kit

Cordex® CXPS-E3 400 A edge power systems can be purchased with an optional battery landing busbar kit (PN: 0250030-550) which provides landing locations for three pairs of back-to-back cable lugs. This kit is customer installed at time of system installation.

### 4.13.3 600 A edge power system battery landing busbar kit

Cordex® CXPS-E3 600 A edge power systems by default come with an extended battery landing busbar kit, either PN: 0250030-531 or PN: 0250030-532, which provides either eight 35 mm<sup>2</sup> (2 AWG) landing points or two 185 mm<sup>2</sup> (350 MCM) landing points. These kits are interchangeable and can be purchased separately and installed by the customer during system installation.

### 4.13.4 900 A edge power system battery landing busbar kit

Cordex® CXPS-E3 900 A edge power systems by default come with battery landings installed. It provides both four 120 mm<sup>2</sup> (4/0 AWG) landing locations and six 35 mm<sup>2</sup> (2 AWG) landing points all through back-to-back mounted connection pairs.

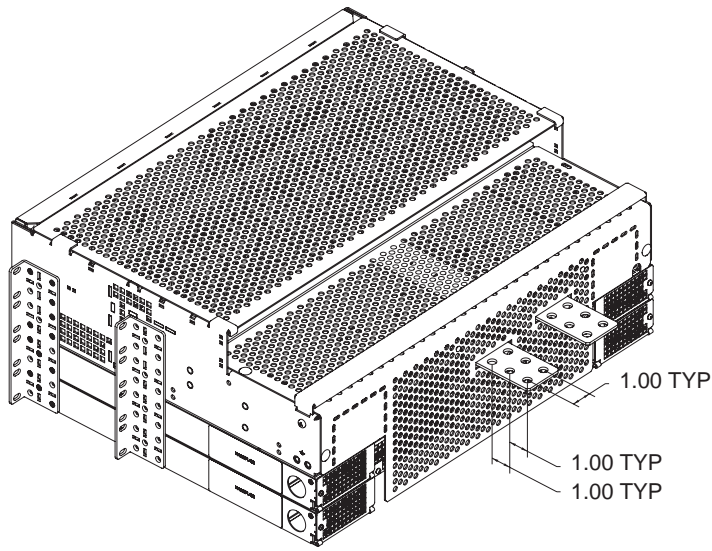

Figure 17: Battery landing busbar kit

## 5. Inspection

---

### 5.1 Packing materials

Alpha Technologies Ltd. is committed to providing products and services that meet our customers' needs and expectations in a sustainable manner, while complying with all relevant regulatory requirements. As such Alpha strives to follow our quality and environmental objectives from product supply and development through to the packaging for our products.

Rectifiers and batteries are shipped on individual pallets and are packaged according to the manufacturer's guidelines.

Almost all Alpha packaging material is from sustainable resources and or is recyclable.

### 5.2 Returns for service



#### NOTICE

**Alpha Technologies Ltd. is not responsible for damage caused by improper packaging of returned products.**

Save the original shipping container. If the product needs to be returned for service, it should be packaged in its original shipping container. If the original container is unavailable, make sure that the product is packed with at least three inches of shock-absorbing material to prevent shipping damage.

### 5.3 Check for damage

Before unpacking the product, note any damage to the shipping container. Unpack the product and inspect the exterior for damage. If any damage is observed, contact the carrier immediately. Continue the inspection for any internal damage. In the unlikely event of internal damage, inform the carrier and contact Alpha Technologies Ltd. for advice on the impact of any damage.

### 5.4 General receipt of shipment

The inventory included with your shipment depends on the options you have ordered. The options are clearly marked on the shipping container labels and bill of materials.

### 5.5 Miscellaneous small parts

Review the packing slip and bill of materials to determine the part number of the configuration kits included with your system. Review the bill of materials to verify that all the small parts are included. Contact us if you have any questions before you proceed.

## 6. Installation

---

Only qualified personnel should install and connect the power components within the power system. For the battery installation, refer primarily to the manufacturer's documentation.

Frequent reference is made to drawings located at the end of this document.

### 6.1 Safety precautions

Refer to the [Safety](#) section near the beginning of this document.

### 6.2 Tools required

Various insulated tools are essential for the installation. Use this list as a guide:

- Battery lifting apparatus if required
- Electric drill with hammer action, ½ inch capacity
- Various crimping tools and dies to match lugs used in installation
- Load bank of sufficient capacity to load largest rectifier to its current limit
- Digital voltmeter equipped with test leads
- Cable cutters
- Torque wrench: ¼ inch drive, 0 to 17 Nm (0 to 150 in-lb)
- Torque wrench: ⅜ inch drive, 0 to 135 Nm (0 to 100 ft-lb)
- Insulating canvases as required
- Various insulated hand tools including:
  - Combination wrenches
  - Ratchet and socket set
  - Various screwdrivers
  - Electricians knife
- Battery safety spill kit required for wet cells only
- Cutters and wire strippers 2.5 to 0.34 mm<sup>2</sup> (14 AWG to 22 AWG)

### 6.3 Installation of external batteries



#### WARNING

Follow the battery manufacturer's safety recommendations when working around battery systems and review the safety instructions provided in this document.

This information is provided as a guideline and is not meant to imply that batteries are part of this power system.

Batteries should be located in a temperature-controlled environment, regulated to approximately 25°C (77°F). Significantly lower temperatures reduce performance and higher temperatures decrease life expectancy.

Provide adequate ventilation. VRLA batteries, though not requiring the special ventilation requirements of a flooded battery, should not be installed in an airtight enclosure. Hydrogen gas can be emitted from a failed battery.

If applicable, clean the cells before assembly according to the battery manufacturer's recommendations. First neutralize any acid with a baking soda and water solution; then wipe the cells with a soft cotton cloth dampened with clean water and wipe dry.

### 6.3.1 Installing batteries

Verify that all battery breakers, DC circuit breakers, and fuses on the distribution panels are either in the OFF position or removed.

Apply a corrosion-inhibiting agent, such as NO-OX-ID® "A," on all battery terminal connections.

1. If required, assemble the battery rack and the cells or mono-blocks as per the installation instructions supplied with the batteries.
2. Ensure that the battery output cabling can reach the positive [+] and negative [-] terminals of the series battery string and that the batteries are oriented correctly for easy installation of the inter-unit series connectors.
3. Remove any NO-OX-ID® "A" grease from battery terminals.
4. Burnish the terminal posts with a non-metallic brush, polishing pad, or 3M Scotch-Brite® scouring pad.
5. Apply a light coating of NO-OX-ID® "A" grease to the terminal posts.
6. If lead plated inter-unit connectors are used, they should also be burnished and NO-OX-ID® "A" grease applied as above. Install the inter-unit connectors.
7. After all battery connections are completed, torque the connections as per the battery specifications typically 11.4 Nm (100 in-lb).

Refer to the system startup procedure before connecting the batteries online.





## 6.5 Power system assembly and mounting

The power system must be mounted in a clean and dry environment. Sufficient free space must be provided at the front and back of the power system. This is to meet the cooling requirements of the rectifiers and to allow easy access to the power system components.



### NOTICE

The power system requires at least 2RU (3.5 inches) of space above the distribution for tooling access to the load breaker ground connections. Ensure that at least 2RU of space is open in the relay rack above the power system distribution. Some of this space may be consumed by the clear plastic cover of the power system in higher ambient temperature environments.

### 6.5.1 Floor mounted systems

Secure the system to a concrete floor using either heavy duty anchors (1/2 inch × 2½ inch), or for wooden floors, heavy-duty lag screws (5/8 inch × 2½ inch). Use appropriately sized flat washers.

If required, use isolation kits to isolate system from the floor.

Secure the relay rack to the overhead cable tray. Alpha® does not supply the mechanical details necessary for overhead support.

### Weight and dimensions

The weight of the systems listed are approximate and exclude rectifiers:

System	Weight
Cordex® CXPS-E3 300 A edge power system 19-inch with one 2.4/3.0 kW shelf	15.9 kg (35.1 lb)
Cordex® CXPS-E3 300 A edge power system 23-inch with one 2.4/3.0 kW shelf	20.1 kg (44.4 lb)
Cordex® CXPS-E3 400 A edge power system 19-inch with two 2.4/3.0 kW shelves	18.2 kg (40 lb)
Cordex® CXPS-E3 400 A edge power system 19-inch with one 4.0/4.6 kW shelf	25.5 kg (56 lb)
Cordex® CXPS-E3 400 A edge power system 23-inch with two 2.4/3.0 kW shelves	26.4 kg (58 lb)
Cordex® CXPS-E3 400 A edge power system 23-inch with two 4.0/4.6 kW shelves	27.2 kg (60 lb)
Cordex® CXPS-E3 600 A edge power system 23-inch with two 2.4/3.0 kW shelves	27.2 kg (60 lb)
Cordex® CXPS-E3 900 A edge power system 23-inch with three 2.4/3.0 kW shelves	45.4 kg (100 lb)

Refer to the drawings at the end of this document for system dimensions.

Dimensions in [Figure 18](#) and [Figure 19](#) are in inches.

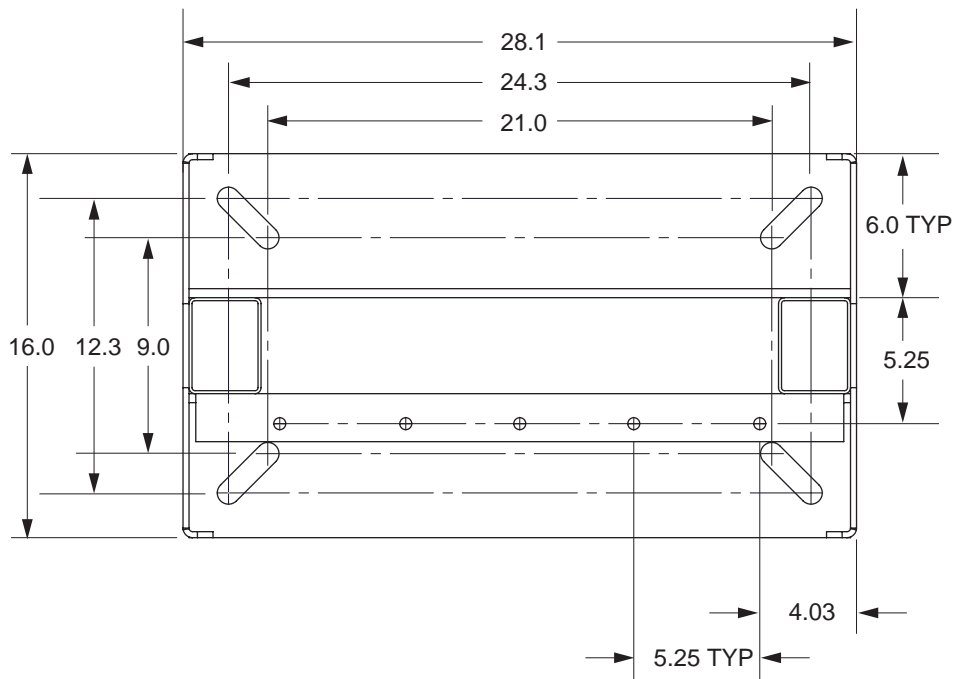

Figure 18: Rack mounting details (top view), welded rack

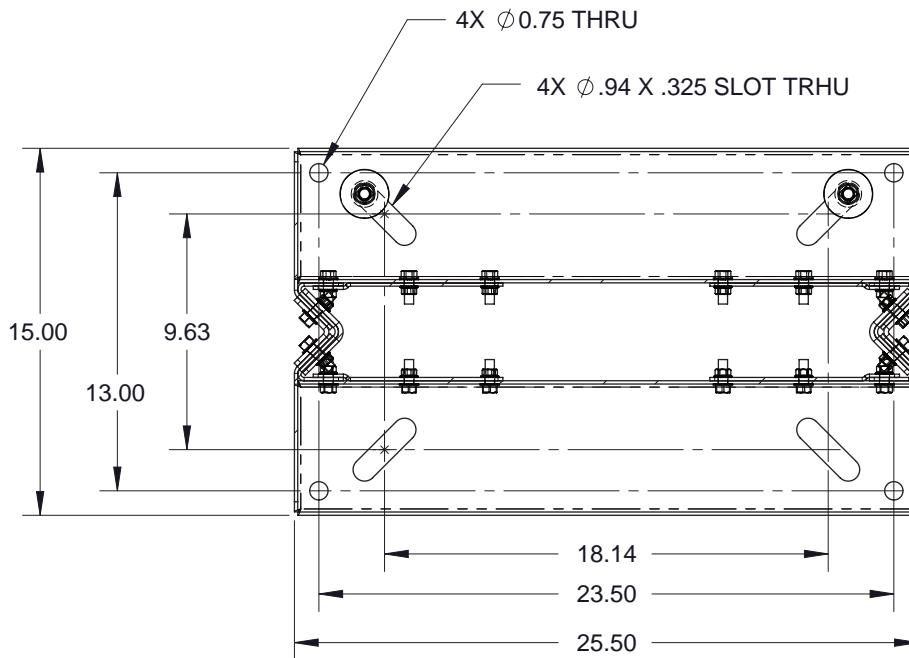

Figure 19: Rack mounting details (top view), bolted rack

## 6.5.2 Rack mounted systems

Attach the power system to the customer-provided relay rack using mounting screws and star washers to ensure an electrical bond between system chassis and relay rack.

19-inch and 23-inch power systems may be either flush or center mounted in the relay rack.

### 6.5.3 Systems mounted in outdoor enclosures operated above 40°C (104°F)

Attach the power system to the customer provided enclosure using mounting screws and star washers to ensure an electrical bond between system chassis and relay rack. 19-inch and 23-inch power systems may be either flush or center mounted in the enclosure.

If the system will be operated in ambient temperatures above 40°C (104°F), the following installation steps must also be followed:

1. The clear polycarbonate top cover must be removed, if applicable.
2. The enclosure design must prevent the operator from touching the output busbars/lug connections.
3. The battery breakers used must be rated 100A or lower, if applicable.
4. Air circulation within the enclosure must be sufficient to maintain the breaker bullets below 105°C (221°F) in all operation conditions.



#### NOTICE

With step 4, the air circulation required is considerably less than what is normally designed into an outdoor enclosure, therefore this should be met by standard designs. However, as cooling performance is very specific to the mechanical implementation, it is recommended to test for compliance under maximum load conditions (using battery discharge test).

## 6.6 Breaker installation

1. Ensure mid-trip breakers are used for load and series-trip breakers are used for battery connections.
2. Turn the breaker **OFF**.
3. Orient the breaker so that the actuator is down with the breaker in the **OFF** position.
4. Align the breaker terminals with the correct holes.
5. Carefully push the breaker into position.
6. Ensure that the breaker is fully inserted so that the flat face of the hexagonal nut is against the mounting surface.

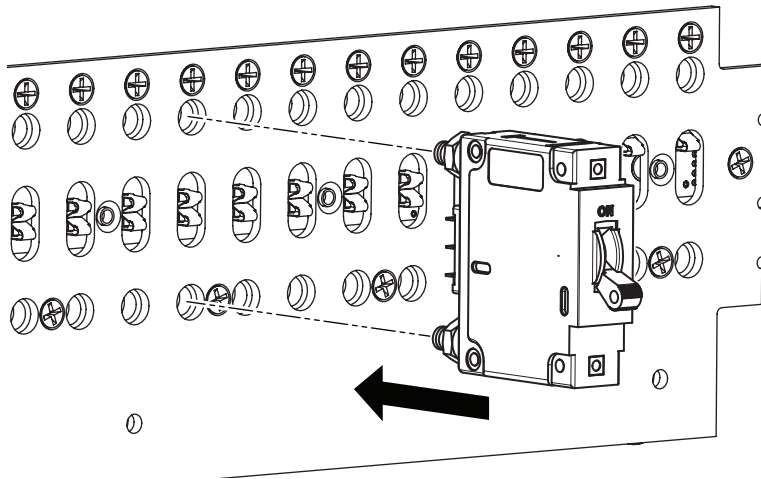

Figure 20: Breaker installation

### 6.6.1 Breaker removal

1. Turn breaker off.
2. Carefully pull the breaker out of position.

## 7. Wiring

This chapter provides cabling details and notes on cable sizing for DC applications with respect to the product.



### WARNING

Ensure that the power is switched off by switching off rectifiers and removing battery line fuses, turn off battery breakers before attempting work on the wiring. Use a voltmeter to verify the absence of a voltage. Clearly mark the correct polarity of the battery leads before starting work on DC connections.

### 7.1 Installation notes

Refer to the Installation section for safety precautions and tools required.



### ATTENTION

Cordex® CXPS-E3 edge power systems must be installed above a non-combustible surface.

#### 7.1.1 Calculating output wire size requirements

Although DC power wiring and cabling in telecommunication applications tend to exceed electrical code requirements, mostly due to the voltage drop requirements, all applicable electrical codes take precedence over the guidelines and procedures in the present chapter, wherever applicable.

Wire size is calculated by first determining the appropriate maximum voltage drop requirement. Use the following formula to calculate the circular mil area (CMA) wire size requirement. Determine the size and number of conductors required to satisfy the CMA requirement.

$$\text{CMA} = (\text{A} \times \text{LF} \times \text{K}) / \text{AVD}$$

**A = Ultimate drain in amps.**

**LF = Conductor loop feet.**

**K = 11.1 constant factor for commercial (TW type) copper wire.**

**AVD = Allowable voltage drop.**

Check again that the ampacity rating of the cable meets the requirement for the installation application. Consult local electrical codes (for example, National Electrical Code® and Canadian Electrical Code) for guidelines. If required, increase the size of the cable to meet the code.

Refer to [Table H](#) for cable size equivalents.

Table H — Cable size equivalents (AWG to Metric)

Cable size	Circular mils	Square millimeters	Equivalent metric cable
20 AWG	1020	0.519	1
18 AWG	1624	0.8232	1
16 AWG	2583	1.309	1.5
14 AWG	4107	2.081	2.5
12 AWG	6530	3.309	4
10 AWG	10380	5.261	6
8 AWG	16510	8.368	10
6 AWG	26250	13.30	16
4 AWG	41740	21.15	25
2 AWG	66370	33.63	35
0 AWG (or 1/0)	105600	53.48	50 or 70

Cable size	Circular mils	Square millimeters	Equivalent metric cable
00 AWG (or 2/0)	133100	67.42	70
0000 AWG (or 4/0)	211600	107.2	120
313 MCM (or kcmil)	313600	159	150 or 185
350 MCM (or kcmil)	350000	177.36	185
373 MCM (or kcmil)	373700	189	185 or 240
500 MCM (or kcmil)	500000	253.36	300
535 MCM (or kcmil)	535300	271	300
750 MCM (or kcmil)	750000	380.00	400
777 MCM (or kcmil)	777700	394	400

## 7.1.2 Required torque values

Table I lists the recommended torque values for connection to the power system with the following hardware:

- Clear hole connections (nut and bolt)
- PEM studs
- PEM threaded inserts
- Thread formed connections (in copper busbar)

Grade 5 rated hardware is required for these torque values.

Size	Torque value
1/4 inch	11.93 Nm (8.8 ft-lb)
3/8 inch	44.06 Nm (32.5 ft-lb)
1/2 inch	98.97 Nm (73 ft-lb)

## 7.2 Grounding

Connect the isolated power system battery return bus (BRB) to the building master ground bus (MGB), or floor ground bus (FGB) in a larger building. This acts as a system reference and as a low impedance path to the ground for surges, transients and noise. The MGB or FGB must have a direct low impedance path to the building grounding system.

The cable from the power system to the MGB or FGB must be sized to provide sufficient ampacity to clear the largest fuse or breaker on the power system, excluding the battery protection fuse or circuit breaker. This is the minimum requirement. Other factors including length of cable and special grounding requirements of the load must also be factored in. The insulated cable must be equipped with two-hole crimp type lugs and must not have any tight bends or kinks.

Power system ampacity	Recommended ground reference conductor size
<30 A	6 mm <sup>2</sup> (10 AWG)
30 A to 100 A	16 to 35 mm <sup>2</sup> (6 to 2 AWG)
100 A to 400 A	107 mm <sup>2</sup> (0000 AWG)
400 A to 800 A	185 mm <sup>2</sup> (350 MCM)
>800 A	400 mm <sup>2</sup> (750 MCM)

The power system frame must also be connected to the MGB or FGB. This is done for personnel safety and to meet many telecom grounding requirements. Each bay must have its own frame or site ground connection. Refer also to the customer connections drawing at the end of this document.

## 7.2.1 Frame ground

There are several options for connecting a frame ground to the power system (select just one option):

- The options highlighted on either side of the power system distribution.
- As highlighted in the Cordex® HP 2.4/3.0 kW Rectifier User Guide, a back connection on the side of the AC termination box.
- If the frame that the power system is installed into is grounded, then it can also be grounded as a final option through the mounting ears on the side of the power system through the frame.

### Connection to power system directly

Connect a cable (matched to maximum size breaker, usually 35 mm<sup>2</sup> (2 AWG) or less) between one of the side panels of the power system to the master ground bus (MGB) or floor ground bus (FGB). This connection can be made using a 1/4 inch × 5/8 inch lug and two 1/4 inch × 20 bolts into the PEM nuts indicated in the following drawing.

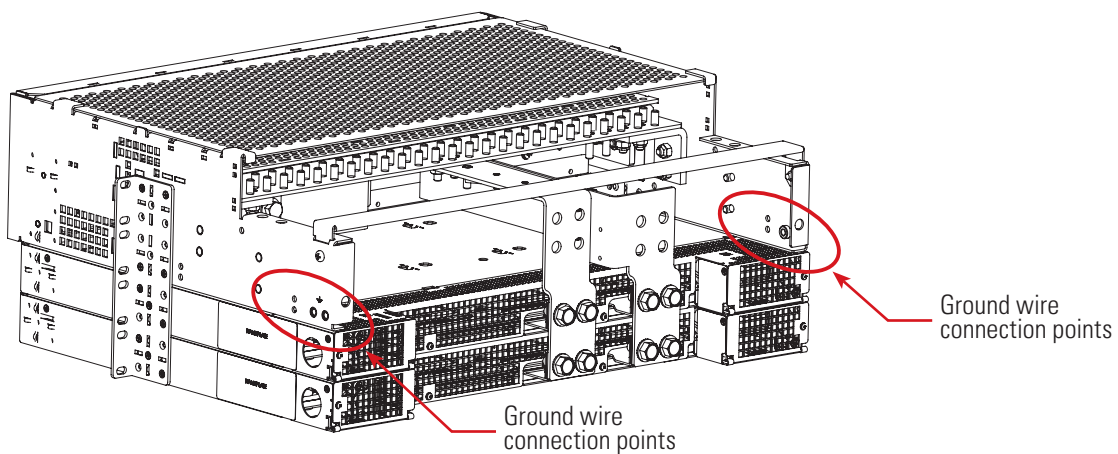

Figure 21: Connecting the frame ground to the power system

### Connection to overhead trays

Connect the power system to the frame using rails using 12-24 self-tapping screws. Ensure paint is removed to ensure a good electrical connection between power system and frame.

Connect a cable to the frame in which the power system is installed. The rack upper crossbar (Figure 22) has five 5/8 inch diameter holes to accommodate threaded rod attachment to the overhead trays. Connect the frame ground 3/8 inch on 1 inch centers and 1/4 inch on 5/8 inch centers. Remove paint in lug contact area to ensure a good electrical connection.

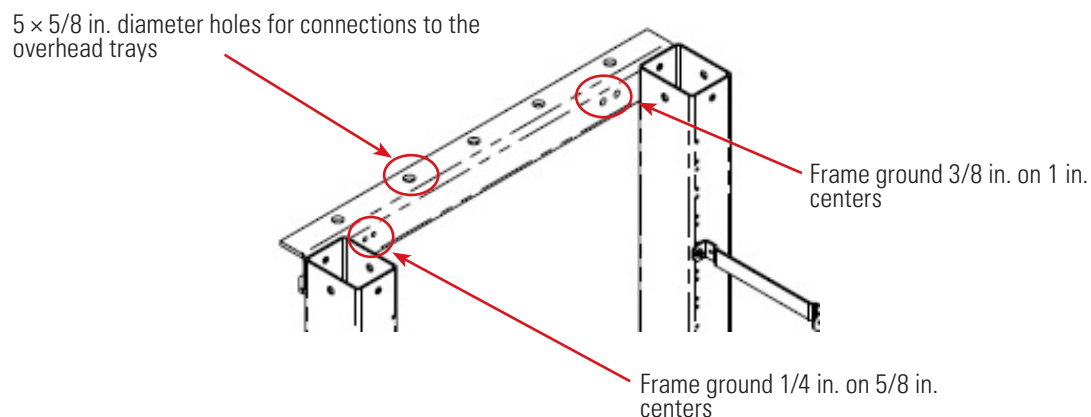

Figure 22: Connecting the frame ground to overhead trays

## 7.2.2 Reference ground

The reference ground should be connected between the building master ground bus (MGB) or floor ground bus (FGB) and the power system internal battery return bus (BRB) in **only one** location.



### ATTENTION

If the MGB or FGB is connected to the power system BRB in more than one location then load current will circulate through the reference ground bond, creating an unsafe condition known as ground loop.

Exact connection should be determined by the site engineer, but in general the recommended connection locations are:

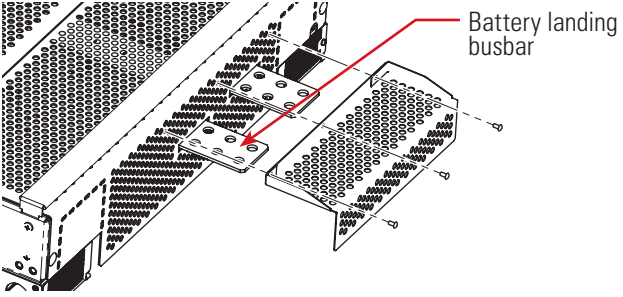
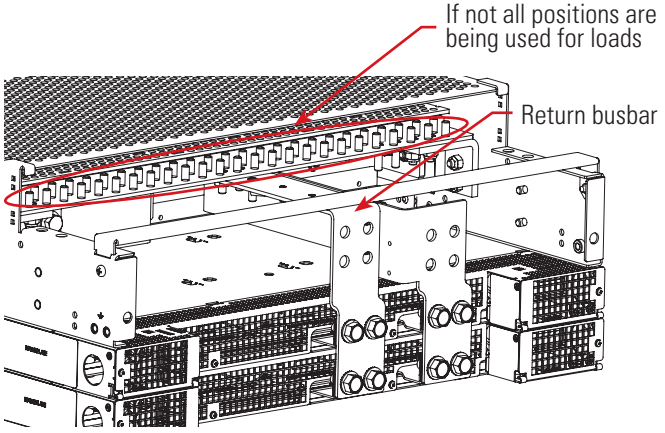
Order of precedence	System characteristic	Connection point
1	2V battery stacks	Battery termination bar
2	Connected to larger power system	Power system internal battery return bus
3	Battery landing busbar	If this option is included (extends out through back cover) 
4	Return bar location	



## 7.3 AC wiring

To ease future access issues, connect the AC circuits to all rectifier shelves at the time of initial installation.



### NOTICE

Verify NO rectifiers are installed in the rectifier shelves at this time.

### 7.3.1 AC feeder protection and sizing



### ATTENTION

To minimize EMI disturbances, route the AC input wires in flexible or rigid conduit and located as far away as possible from the DC power wires.

To maximize system reliability, each feed should have a dedicated protection feeder breaker located at the AC distribution panel. The feeder breaker can also act as the disconnect device for the connected modules.

### 7.3.2 AC wiring for 2.4/3.0 kW rectifier shelves

Cordex® HP 2.4/3.0 kW rectifier shelves used within power systems are 19-inches or 23-inches in width. The individual rectifier shelves are wired to the customer provided AC termination panel. The AC input is routed through a 3/4 inch trade size knockout on the side of the shelf for a direct connection. The AC wiring size can vary based on local electrical codes.

The recommended AC breaker and wire gauge sizes are as follows:

Rectifier shelf	Recommended AC breaker size	Recommended AC wire size
Single phase, 208Vac to 277Vac	23-inch breaker = two 40 A and one 20 A AC breakers	10 mm <sup>2</sup> (8 AWG) for 40 A breakers
	19-inch breakers = four 20 A AC breakers	4 mm <sup>2</sup> (12 AWG) for 20 A breakers



### CAUTION

Use care when removing or replacing the covers for the AC input connections. Never assume that an electrical connection or conductor is not energized.

Refer to the [Specifications in Section 3](#) for further details.

1. Ensure that all modules are removed from the shelf.
2. At the back of the shelf, remove screw and flip the cover down (two places) to access the AC input terminal blocks: each terminal pair corresponds to either two rectifiers or a single rectifier as shown in [Figure 23](#).
3. The wire way is designed for two customer-supplied, 3/4 inch conduit fittings for the AC supplies located one on each side of the shelf. Attach the conduit retainers to the wire way holes and route the AC cables through them.
4. Secure the wires to the AC input and AC ground terminals. Refer to the customer connection drawing at the end of the document.
5. Tighten the cable connector to the AC cable (conduit similar).
6. Replace back covers once all connections have been completed.

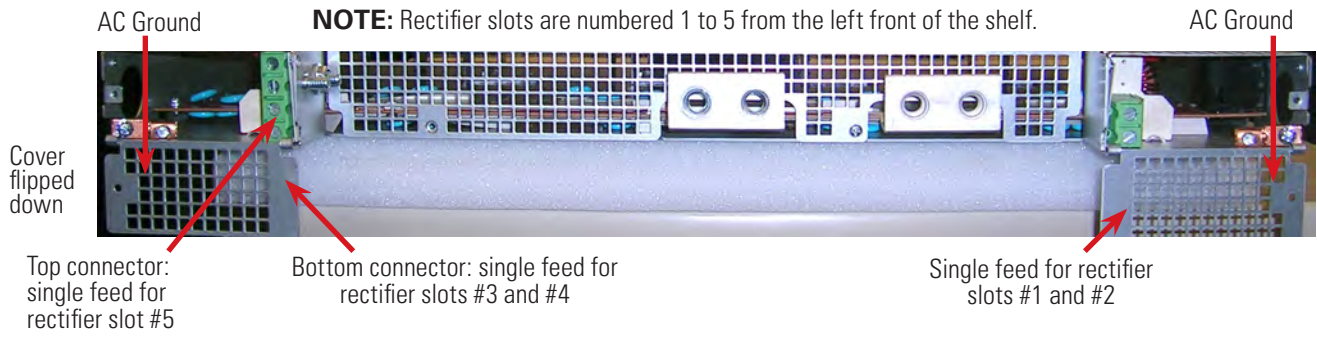

Figure 23: AC input and ground for 23-inch shelf

## 7.4.2 AC wiring for 4.0/4.6 kW rectifier shelves

Cordex® HP 4.0/4.6 kW rectifier shelves used within power systems are 19-inches or 23-inches in width. The individual rectifier shelves are wired to the customer provided AC termination panel. The AC input is routed through a 1-inch trade size knockout on the side of the shelf for a direct connection. The AC wiring size depends upon the rectifier shelf voltage configuration and the local electrical code.

The recommended AC breaker and wire gauge sizes are as follows:

Rectifier shelf	Recommended AC breaker size	Recommended AC wire size
Single phase, 208Vac to 277Vac	6 × 30 A AC breakers	6 mm <sup>2</sup> (10 AWG)
Three phase, 208Vac (without neutral)	2 × 50 A AC breakers	16 mm <sup>2</sup> (6 AWG)
Three phase, 277Vac/480Vac (with neutral)	2 × 30 A AC breakers	6 mm <sup>2</sup> (10 AWG)

## 7.4.3 AC wiring for 4.0 kW rectifier shelves

[Figure 24](#) shows the AC connections for one of the rectifier shelves. For other AC connection options (for example, single phase), refer to the rectifier shelf document that ships with your system.

Terminate flex conduit at rectifier shelves—one connection each side.

AC wireway 1.313 in. for  
1 in. conduit

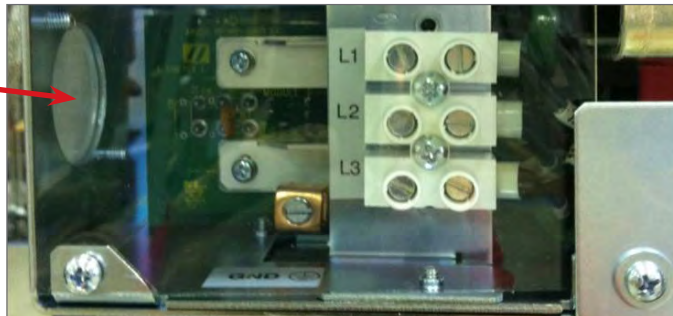

Figure 24: Shelf AC connection (three-phase, three-wire shown with back cover removed)

## 7.4 DC wiring



### CAUTION

Leave cables or busbars disconnected at the battery and verify the output polarity using a voltmeter. Make battery connections only after all other wiring is completed.

DC output wire must be UL approved XHHW or RHH/RHW (for Canadian users, RW90 Type). Control and sense wires must be UL approved Style 1015 (for Canadian users, TEW type).

The common output leg of the rectifier system must be connected to ground, typically at the battery return bus.

### 7.4.1 External battery bay output connections

Battery cables must be sized for a 0.25 volt drop from the battery to the power system at full load including anticipated growth. The cables must also meet ampacity requirements. Cables terminating directly on the battery posts or connection details must be secured so that there is no stress on the battery posts. Lead plated lugs and lead plated or stainless steel hardware must be used on all terminations at vented batteries to reduce corrosion.

1. Prepare, route, and connect cables from the power system to the battery termination details—connections are available for both hot and return.
2. Burnish the terminating points and apply a corrosion-inhibiting agent, such as NO-OX-ID "A," to all battery terminal connections.
3. Do not complete the final live connections to the battery. Leave open and insulate the final connections or remove the battery fuses. Switch off the battery contacts if used.

Refer to the system startup procedure before connecting the batteries online.

## 7.5 Distribution cabling

### 7.5.1 Load planning and breaker (fuse) spacing



#### CAUTION

For applications when the power system is subjected to ambient temperatures above 55°C (131°F) it must be installed inside equipment such that unintentional contact with the area of the side panels between the mid-mount bracket and the back of the unit is unlikely. For clarity this is the area marked with a "Caution - Hot" label.



#### NOTICE

Connect breaker returns before hot connections.

Because breakers and fuses generate most of the heat in a system, care must be taken in the layout of high current breakers and fuses. Specific guidelines are as follows:

#### For Cordex® CXPS-E3 300 A edge power systems

1. Any single pole over current protection device (OCPD) rated at 125 A can be mounted in pairs, but cannot have an OCPD installed on either side of the pair.
2. Any single pole OCPD rated at 100 A and below can be mounted in any position without spacing.
3. The highest rated bullet fuse that can be used is 125 A. The highest rated single pole breakers that can be used for a load is 100 A. The highest rated single pole breaker that can be used for batteries is 125 A at temperatures below 55°C (131°F) and 100 A for temperatures above 55°C (131°F).

While these guidelines require some planning, they do not limit achieving the maximum 300 A capacity for any breaker size combination (except if many small breakers are used).

#### For Cordex® CXPS-E3 400 A edge power systems

1. Any single pole over current protection device (OCPD) rated at 125 A can be mounted in pairs, but cannot have an OCPD installed on either side of the pair.
2. Any single pole OCPD rated at 100 A and below can be mounted in any position without spacing.
3. The highest rated bullet fuse that can be used is 125 A. The highest rated single pole breakers that can be used for a load is 100 A. The highest rated single pole breaker that can be used for batteries is 125 A at temperatures below 55°C (131°F) and 100 A for temperatures above 55°C (131°F).

While these guidelines require some planning, they do not limit achieving the maximum 400 A capacity for any breaker size combination (except if many small breakers are used).

#### For Cordex® CXPS-E3 600 A edge power systems

1. The highest rated single position fuse holder is 125 A.
2. The highest rated single pole breaker for a load is 100 A.
3. Any single pole breaker rated above 90 A must not have any over current protection device (OCPD) installed in the positions on either side of it.
4. Any single pole breaker rated 90 A and below can be mounted in any position without spacing.
5. The single position fuse holder can be mounted without spacing (except in reference to item 2).

#### For Cordex® CXPS-E3 900 A edge power systems

1. Any single pole over current protection device (OCPD) rated at 125 A can be mounted in pairs, but cannot have an OCPD installed on either side of the pair.
2. Any single pole OCPD rated at 100 A and below can be mounted in any position without spacing.

- The highest rated bullet fuse that can be used is 125 A. The highest rated single pole breakers that can be used for a load is 100 A. The highest rated single pole breaker that can be used for batteries is 125 A at temperatures below 55°C (131°F) and 100 A for temperatures above 55°C (131°F).

While these guidelines require some planning, they do not limit achieving the maximum 450 A capacity for any breaker size combination (except if many small breakers are used).

## 7.5.2 Load connections

For wire sizing refer to guidelines supplied with the load equipment.

Terminate distribution cabling with 1/4 inch to 5/8 inch center lugs for connecting to the power system distribution. Always make the return connection to the power system, and then verify the nut tightening torque before installing the hot connection as once the hot connection is in place it is difficult to access the return connection.

Always use the supplied hardware (nuts) for attaching the lugs. The supplied nuts have a serrated flange which eliminates the need for a second lock washer both allowing more threads to show after a completed connection and avoiding thin hardware which can fall through small gaps in the equipment covers.

### Load and battery breaker return connections

- Secure cables with two hole lugs to the 1/4 inch studs on 5/8 inch centers using the supplied hardware.
- Run cables directly out the back of the distribution panel.

### Load and battery breaker hot connections

- Secure cables with two hole lugs to the 1/4 inch studs on 5/8 inch centers using the supplied hardware.
- Run cables directly out the back of the distribution panel above the breaker return cables.

## 7.6 Alarm and signal connection

The I/O capabilities of the power system allow the user to extend various alarm or control signals to an external site monitor via output relays or monitor various analog and digital signals via analog and digital inputs.

For terminal block connections, the recommended wire sizes are 0.14 to 1.50 mm<sup>2</sup> (26 to 16 AWG) for the temperature range of 0°C to 75°C (32°F to 167°F) as per UL/CSA.



### CAUTION

To reduce risk of fire, use only 0.14 mm<sup>2</sup> (26 AWG) or larger wire.

Route via wire-ways and use existing cable clamps or lances to secure to existing (factory) wire harness along with customer run signal wires. Ensure signal wires are routed along hinge point of front door so door opening and closing won't require excess wire slack.

Terminal block connections for the ADIO peripheral should be routed along the left side of the power system (looking at unit from front). Connections to the controller and ADIO peripheral should be routed along the right hand side of the power system. Refer to the customer connections (-08) drawing at the end of this document for details on terminal block assignments.

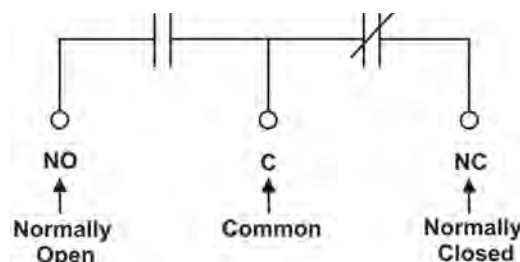

Figure 25: Alarm (relay) connections

### 7.6.1 Alarm (relay) outputs

Terminals provide contacts for extending various alarm or control signals. Each relay output can be wired for normally open (NO) or normally closed (NC) operation during an alarm or control condition. Relays can be programmed to energize or de-energize during an alarm condition. See the controller software manual for programming.

### 7.6.2 Digital inputs

The digital input channels are used to monitor various alarm and control signals. All input channels are voltage activated and accept a bipolar (that is, negative or positive) DC signal directly.

### 7.6.3 Connection method

Typical Alpha® systems use the reset with Hot and trigger with Ground connection. The digital input is wired in such a way that the Hot is wired directly into one of the input terminals; for example, negative input for 48V systems. The other input terminal is wired to the Ground (common) of the system through a relay (dry contact – usually located on the equipment requiring monitoring). This method (see [Figure 26](#)) allows the digital input to receive (or not receive) a Ground signal on an alarm.

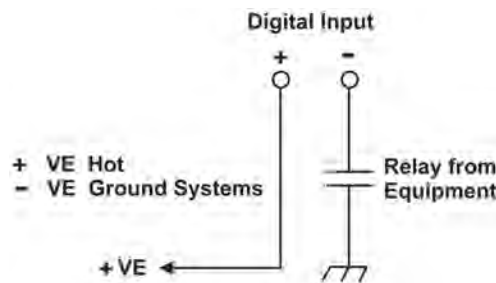

Figure 26: Digital input connection method

Table K — Voltage level definitions for digital inputs

Voltage range (Vdc)	Voltage level (Vdc) considered as "0" (Off)	Voltage level (Vdc) considered As "1" (On)
-60 to +60 (system voltage setting)	-1 to +1	(-60 to-5) or +5 to +60)



## 7.6.4 Programming the digital input

The digital input channels can be programmed for active high or active low. Active high indicates alarm on the presence of a ground signal and active low indicates alarm on the removal of a ground signal. See the controller software manual for detailed instruction on programming.



### ATTENTION

Ensure that the correct polarity is used for all input cable terminations.

## 7.6.5 Analog inputs

The analog input channels are used to monitor various types of electrical signals. The analog channels are labeled to receive specific signals. The input cables should be bundled together and routed through the entry holes.

Default configurations and terminal numbers described in this chapter have been summarized in the drawings located at the end of this document.

## 7.7 Network and remote communication

The system can be set up, monitored and tested via an Ethernet IEEE 10/100 BASE-T serial data connection and accessed via the controller or a web interface. Pin-outs are shown in the customer connections drawing.

Some standard scenarios are described:

- **Network connection:** The Ethernet port is designed to connect the controller to a user supplied network (TCP/IP supplied by the user) via a front panel RJ45 port. Use a standard network cable for this connection.
- **Local connection:** The Ethernet port can also be used for local access such as using a laptop computer. Use a standard Ethernet cable for this connection.

## 7.8 Connecting battery temperature sensor

1. Locate the battery temperature sensors from the ADIO peripheral coiled below the distribution panel.
2. Uncoil and connect the temperature sensors to a battery termination post negative in each battery tray.

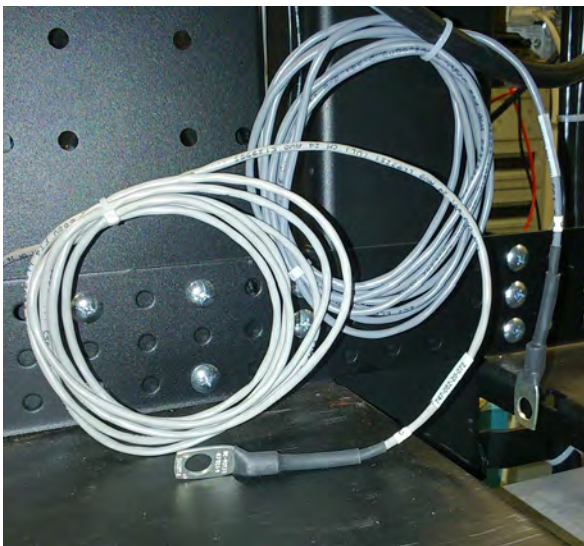

Figure 27: Battery temperature sensor



Figure 28: Battery temperature sensor, battery bay

### 7.8.1 Load distribution

Refer to guidelines supplied with the load equipment. Typically, distribution cables are sized to provide a 0.5 volt loop drop at full load and meet the ampacity requirements of the protection fuse or circuit breaker.

## 7.9 Signal wiring

1. Use the Form C relay contacts on the ADIO peripheral to extend various alarm or control signals to an external site monitor. [Figure 30](#) shows the peripheral alarm relay pinouts. [Table L](#) lists the factory default settings.
2. Use 0.14 mm<sup>2</sup> (26 AWG) or larger wire.
3. Bundle signal wires together and route through the top of the bay.

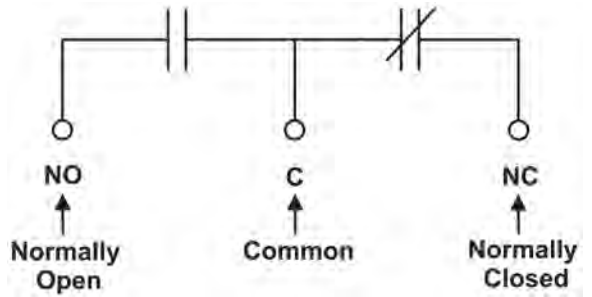

Figure 29: Relay connections, not energized state

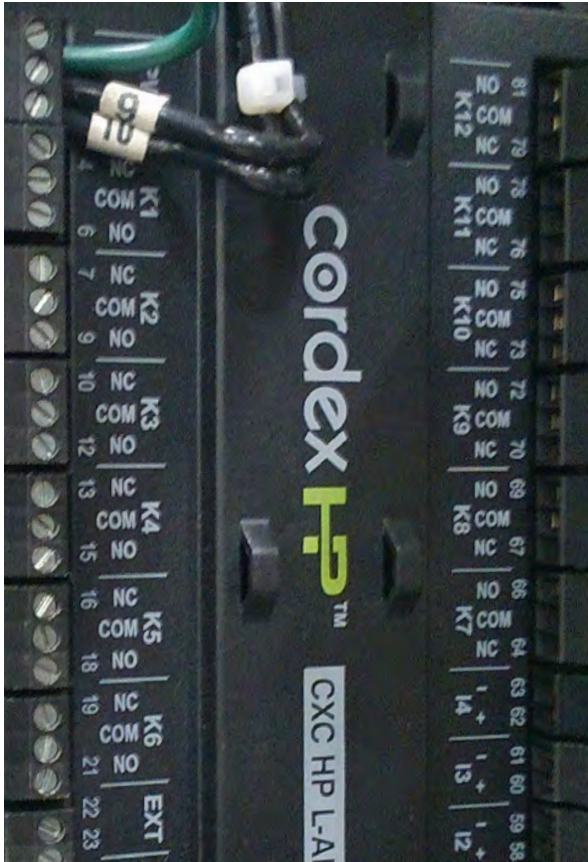

Figure 30: Alarm relay pinouts

Channel description	Factory default designation
LCD fail alarm	Not configurable
Relay K1 to K5	LVD1 or not used
Relay K6 to K8	User configurable
Relay K9	AC MAINS HIGH/LOW alarm
Relay K10	SYSTEM MINOR alarm
Relay K11	SYSTEM MAJOR alarm
Relay K12	SYSTEM CRITICAL alarm

### 7.9.1 Relays

Relays can be programmed to be energized or not energized during an alarm condition. See the controller software manual for programming. Relays can be reassigned in the **Relays** table. From the controller's main **Dashboard** go to **Modules**. In the **CAN Modules** table, select the module and select the **GOTO** button.

For more information, refer to the ADIO maintenance section of the Cordex® CXC HP System Controller Software Manual (User Guide ID: 0350058-J0).



## 8. System startup

---

After completing the system installation and power system wiring, perform the following startup and test procedure to ensure proper operation.

1. Visually inspect the installation thoroughly.
2. Verify:
  - AC input power is off.
  - Batteries are disconnected.
  - All breakers are off and no GMT fuses installed if any loads are connected.
  - All power modules are removed from the shelf.
3. Triple-check the polarity of all connections.
4. Install one rectifier module into the front left-most position using the side of the shelf as a guide.
  - Place the rectifier module on the shelf.
  - Slide the module into the back connector inside the shelf.
  - Apply pressure on the module front panel to engage the back connector in the shelf receptacle.
5. Verify that the AC input voltage is correct and that the breaker switch for the corresponding feeder breaker is **ON**. The power module OK LED will illuminate after a preset start delay.
6. Test the functionality of various module alarms and controls using the controller's built-in display or web interface.
7. Verify the correct battery polarity using a voltmeter. Ensure that no cells or batteries are reversed.
8. Connect the batteries to the output of the system.
9. Install the remaining power modules.
10. Configure the battery parameters according to the battery manufacturers recommendations. See the controller software manual for detailed instructions on how to configure the batteries.
11. From the **Systems > DC System > System Functions > Equalize & Boost** menu of the controller, set the float and equalize voltage to the levels specified by the battery manufacturer.
12. Use the controller to test the functionality of various module alarms and controls especially the battery breaker alarm test. Verify alarms are transmitted to site monitor.
13. Perform a load test with the system using a resistive load box.
14. Enable the temperature compensation feature in the **Systems > DC System > System Functions > Temperature Compensation** menu. Program the settings for slope and breakpoints (upper and lower) with respect to the specific batteries used.

## 8.9.1 Factory ranges and default values

[Table M](#) lists the rectifier settings, ranges, and default values. Changes are made through the controller interface.

Table M — Rectifier factory ranges and default values		
Setting	Range (minimum to maximum)	Default
Float (FL) voltage	47.5 to 58.2V	54V
Equalize (EQ) voltage	49.8 to 60.2V	55V
Battery test (BT) voltage	44 to 52V	46V
Over voltage protection (OVP) <sup>1</sup>	63V	63V
Current limit (CL)	23 to 100%	100%
Power limit (PL)	0 to 100%	100%
Module start delay	0 to 250s	1s
System start delay	0 to 600s	0s
Low voltage alarm (LVA)	42 to 52V	44V
High voltage alarm (HVA)	52 to 63V	55.5V
EQ timeout	1 to 2399h	30h
BT timeout	1 to 250h	8h
Softstart ramp-rate	Normal/Fast	Normal
CL/PL alarm	Enable/Disable	Enable
Remote shutdown	Enable/Disable	Enable
Ramp test	Enable/Disable	Enable

<sup>1</sup> The OVP cannot be set below the present system/FL/EQ/BT voltage setting or the safe mode voltage of 51.4V.

## 9. Maintenance

Although very little maintenance is required with Cordex® power systems, routine checks and adjustments are recommended to ensure optimum system performance. Qualified service personnel should do the repairs. The following table lists a few maintenance procedures for this system. These procedures should be performed at least once a year.

To order more breakers refer to the options listed in the specifications. Always replace circuit breakers with the same type and rating.

Consult support or sales for all replacement parts.



### WARNING

Use extreme care when working inside the unit while the system is energized. Do not make contact with live components or parts.



### ATTENTION

Circuit cards, including semiconductor devices, can be damaged by static electricity. Always wear a grounded wrist strap when handling or installing circuit cards.



### ATTENTION

Ensure redundant modules or batteries are used to eliminate the threat of service interruptions while performing maintenance on the system's alarms and control settings.

Table N — Sample maintenance log

Procedure	Date completed
Inspect all system connections. Re-torque if necessary.	
Verify alarm/control settings.	
Verify alarm relay operation.	
Clean ventilation openings of the rectifiers and converters.	

## 9.1 Controller lithium battery replacement

A removable CR2032 lithium battery is located at the top of the controller it is designed to be field replaceable and can be easily removed with no tools. The battery life is rated up to three years, but should be replaced if the panel does not maintain date and time during power interruption. It is also recommended to replace when the lithium battery voltage is less than 2.6Vdc.

Depress the two front panel latches and tilt the front panel forward and down. Remove the battery from the slot and replace with the same type of battery observing the correct polarity.



### NOTICE

If the controller is powered off when the battery is replaced, time will be lost. Once the controller is powered on, reset the time.



Figure 31: Controller battery replacement

## 9.2 300 A and 400 A LVD override operation



### ATTENTION

Before removing a controller from a live system or performing controller maintenance, an external LVD override is required to avoid a disruption of service.

The LVD control functions are hardwired directly from the assigned relay output to an optional LVD override control located in the power system distribution panel below the breakers. The override bypasses the LVD auto control function. The LVD override board has three indicators:

1. **BUS PWR:** On (green LED) if voltage is present on the bus which powers the LVD coil.
2. **COIL PWR:** On (green LED) if the coil is powered (and LVD is closed). If the LVD override switch is in the **NORMAL** position, a green LED indicates that the controller has activated the LVD.
3. **Override:** On (yellow LED) confirms that the LVD override switch is on. The status of the LVD override switch is also available through the controller when present.

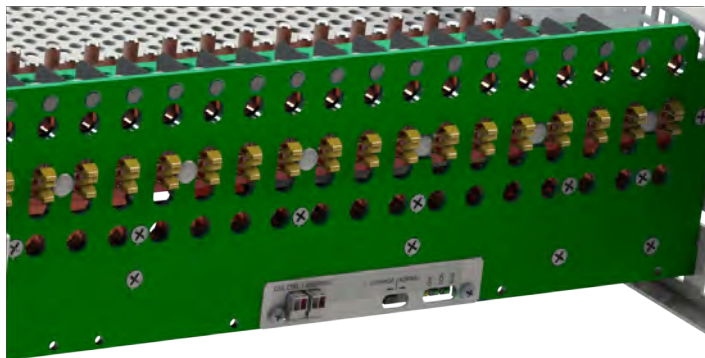

Place the LVD control switch to the **OVERRIDE** position to keep the LVD contactor engaged.

To allow the controller to resume automatic control of the LVD contactor, check that the **AUTO IN** (green) LED is lit confirming that the controller will keep the LVD contactor engaged. Then you can return the LVD control switch to the **NORMAL** position.

## 9.3 600 A LVD override operation

Refer to [4.11 600A LVD override on page 28](#) for more information.



### ATTENTION

Do not leave the switch in the **OVERRIDE** position. Doing so may result in a complete discharge of the batteries during a power failure situation.

## 10. Acronyms and definitions

<b>AC</b>	Alternating current
<b>ANSI®</b>	American National Standards Institute
<b>AWG</b>	American Wire Gauge
<b>BTU</b>	British thermal unit
<b>CAN</b>	Controller area network
<b>CEC</b>	Canadian Electrical Code
<b>CSA®</b>	Canadian Standards Association
<b>CX</b>	Cordex® series; CXC for Cordex system controller
<b>DC</b>	Direct current
<b>DHCP</b>	Dynamic Host Configuration Protocol
<b>EIA</b>	Electronic Industries Alliance
<b>EMC</b>	Electromagnetic compatibility
<b>EMI</b>	Electromagnetic interference
<b>ERM</b>	Electromagnetic Compatibility and Radio Spectrum Matters
<b>ESD</b>	Electrostatic Discharge
<b>FCC</b>	Federal Communications Commission (for the US)
<b>HVSD</b>	High voltage shutdown
<b>IEC®</b>	International Electrotechnical Commission
<b>IEEE®</b>	The Institute of Electrical and Electronics Engineers, Inc.
<b>IP</b>	Internet Protocol
<b>LED</b>	Light emitting diode
<b>LVD</b>	Low voltage disconnect
<b>LVBD</b>	Low voltage battery disconnect
<b>MIL</b>	One thousandth of an inch; used in expressing wire cross sectional area
<b>MOV</b>	Metal oxide varistor
<b>MUX</b>	Multiplexer
<b>MTBF</b>	Mean time between failures
<b>NC</b>	Normally closed
<b>NEC®</b>	National Electrical Code® (for the US)
<b>NO</b>	Normally open
<b>OSHA</b>	Occupational Safety & Health Administration
<b>OSP</b>	Outside Plant
<b>OVP</b>	Over voltage protection
<b>RU</b>	Rack unit (44.45 mm; 1.75 in.)
<b>TCP/IP</b>	Transmission Control Protocol / Internet Protocol
<b>THD</b>	Total harmonic distortion
<b>TVSS</b>	Transient Voltage Surge Suppressor
<b>UL®</b>	Underwriters Laboratories®
<b>UATS</b>	Universal Automatic Transfer Switch
<b>VRLA</b>	Valve regulated lead acid

CORDEX® CXPS-E3 900A EDGE POWER SYSTEM  
CUSTOMER CONNECTIONS

BREAKER RETURNS 36 & 37 ARE BLOCKED.  
SEE DETAIL B FOR ALTERNATIVE RETURN LANDINGS

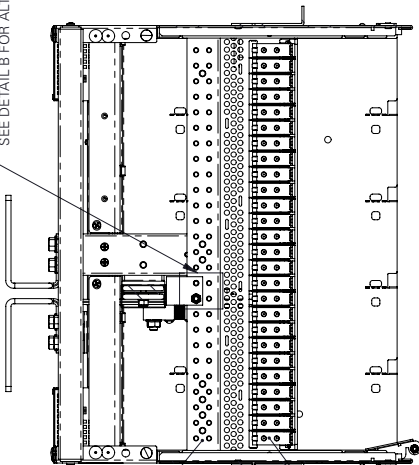

BREAKER RETURNS  
1/4-20 HARDWARE ON 5/8" CENTERS

BREAKER OUTPUTS  
1/4-20 HARDWARE ON 5/8" CENTERS

RETURN LANDING FOR 4 X 4/0 BATTERY  
LUGS, Ø0.406 HOLES ON 1" CENTERS,  
& 6 X 2AWG BATTERY LUGS  
Ø0.302 HOLES ON 5/16" CENTERS.

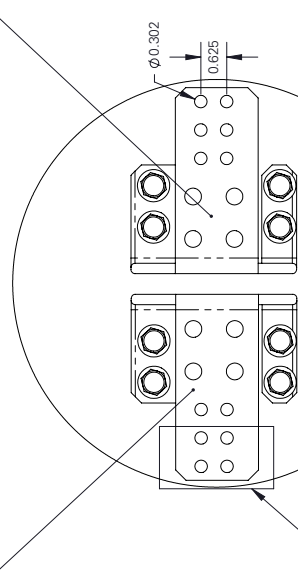

SECTION A-A

2X ALTERNATE BREAKER RETURN LANDINGS

LOAD BREAKERS 1-26

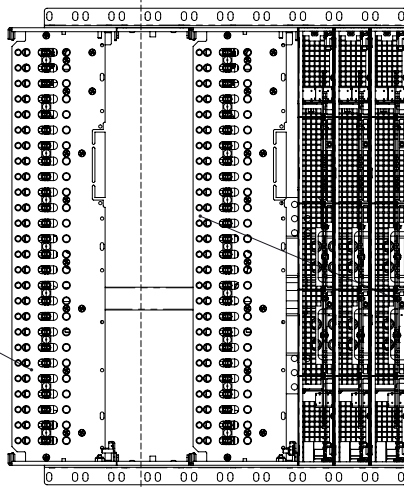

LOAD BREAKERS 27-52

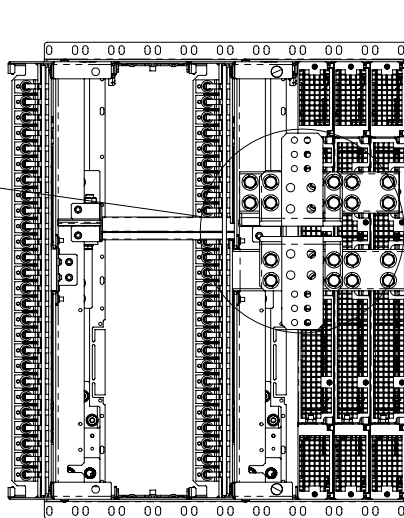
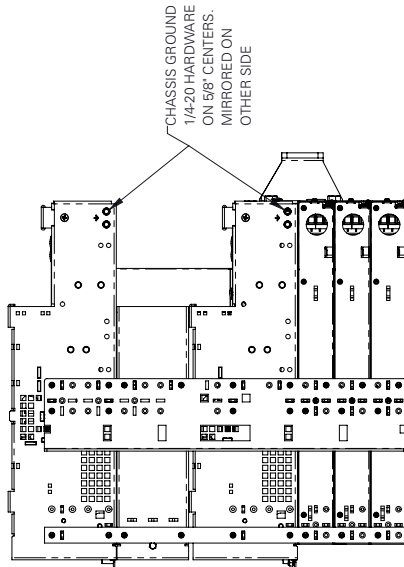

DETAIL B

CORDEX® CXC-HP L-RADIO MODULE  
(SHEET 3)

CORDEX® CXC-HP CONTROLLER

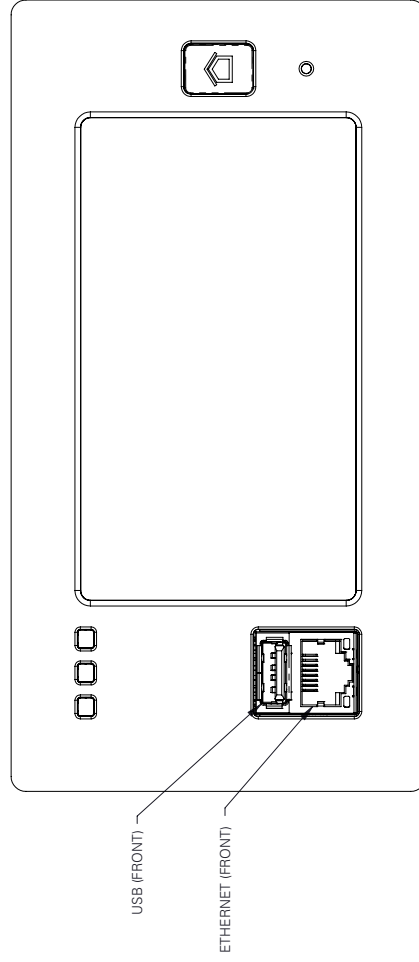
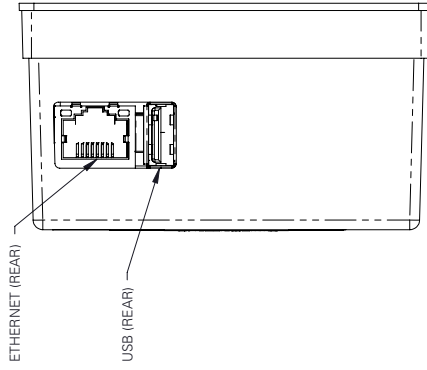
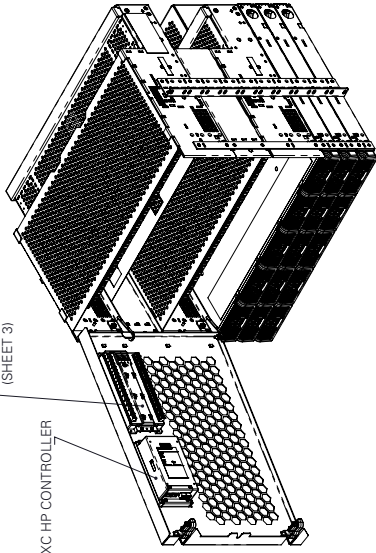

CORDEX® CXC-HP CONTROLLER

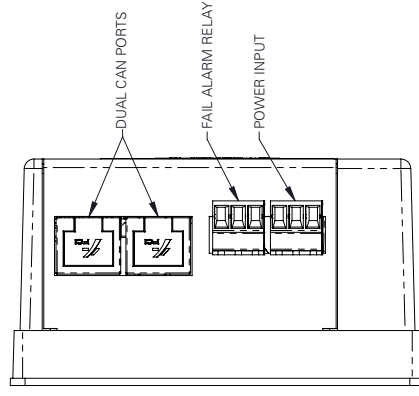



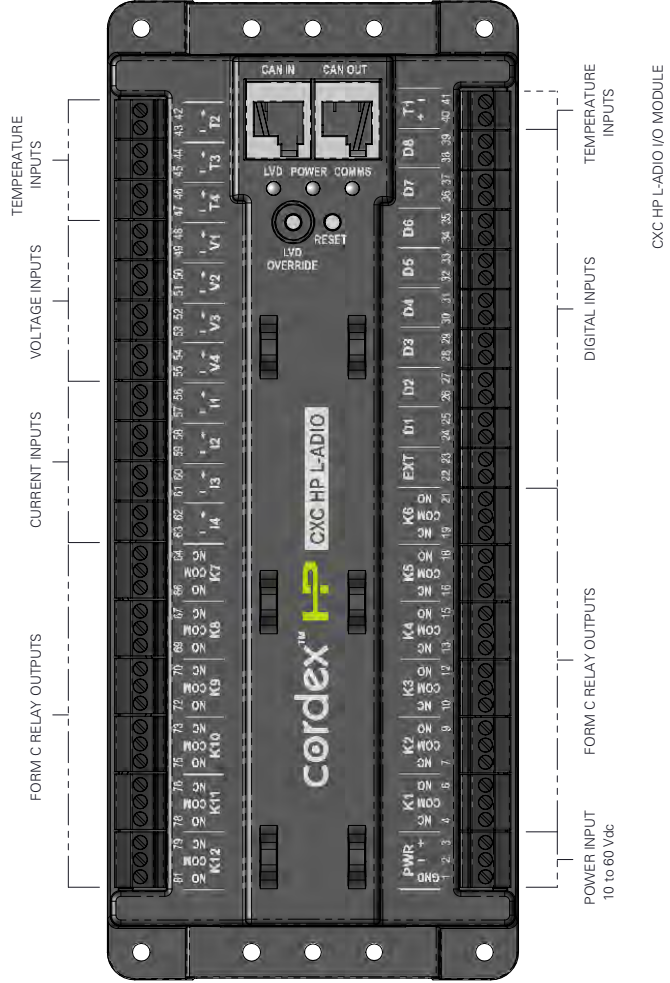
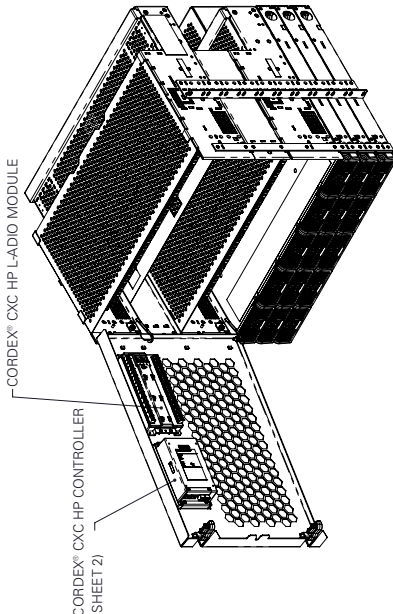

CORDEX® CXPS-E3 900A EDGE POWER SYSTEM  
OUTLINE

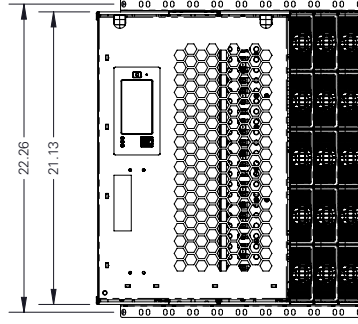
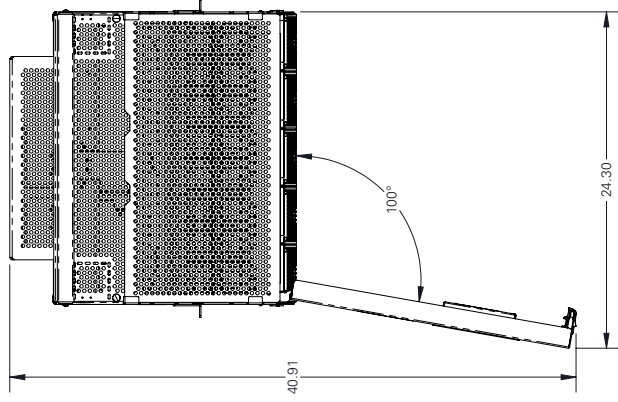

0250042-002 INDOOR

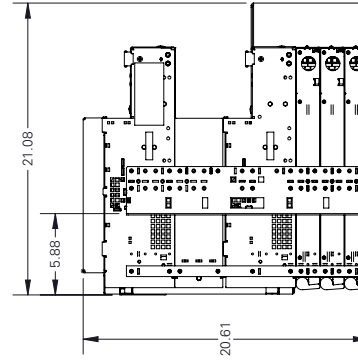
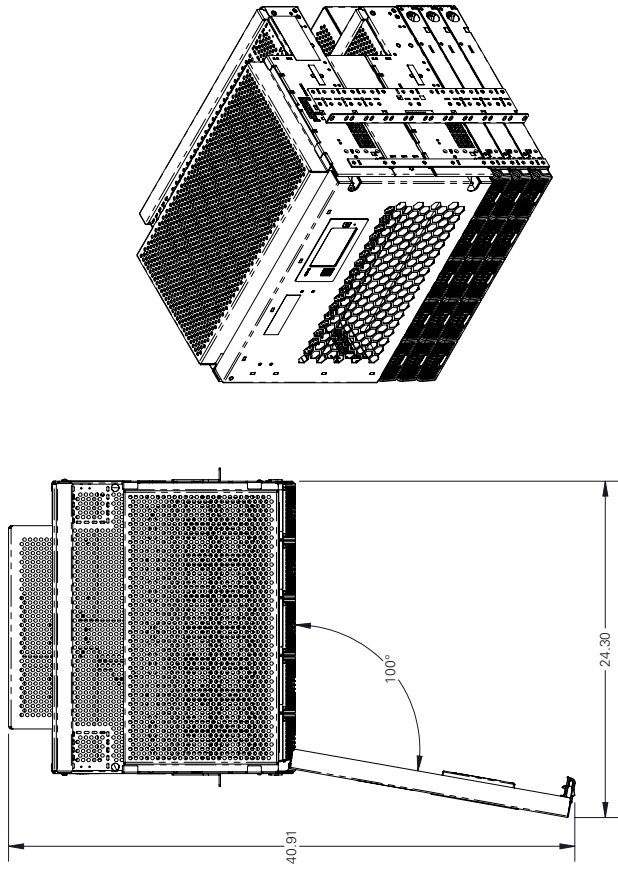

0250042-001 OUTDOOR

CORDEX® CXPS-E3 / CXDM-E3  
 OUTLINE DRAWING

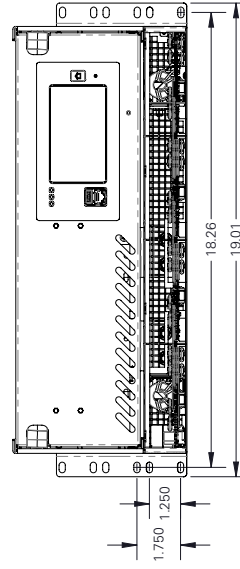
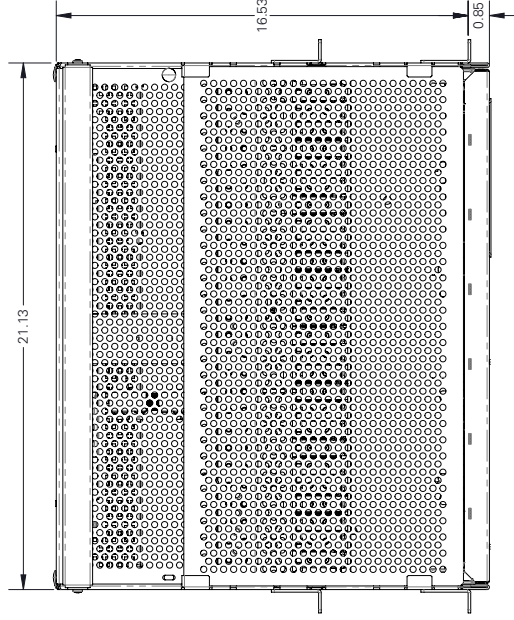
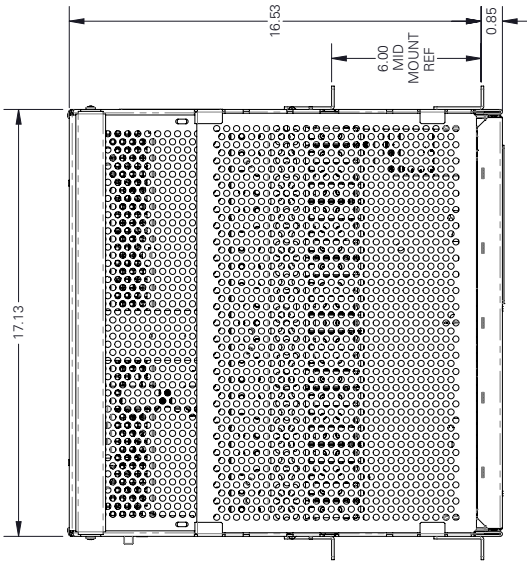

0250030-009  
 0250030-010  
 0250030-011  
 0250030-012

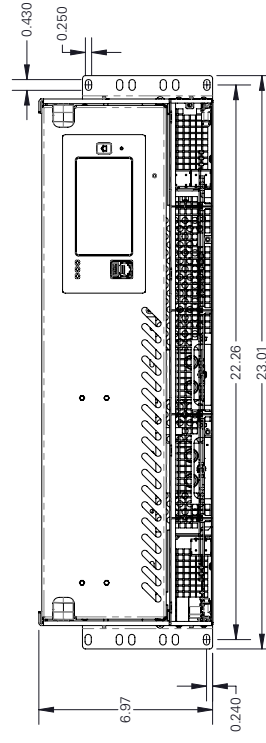

0250030-001  
 0250030-002  
 0250030-003  
 0250030-004

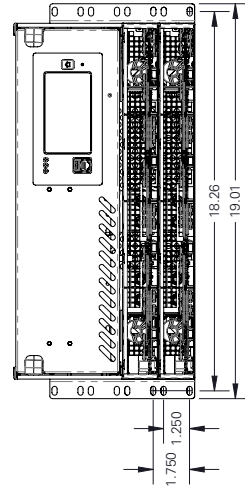
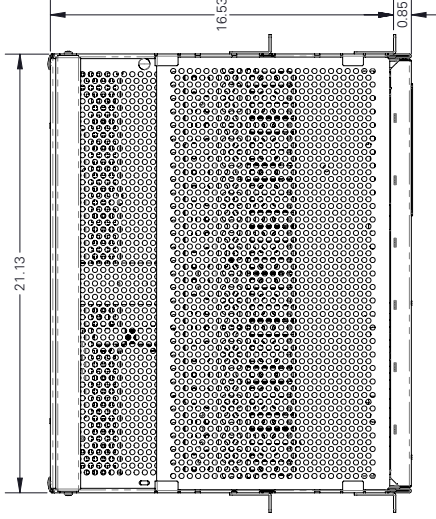
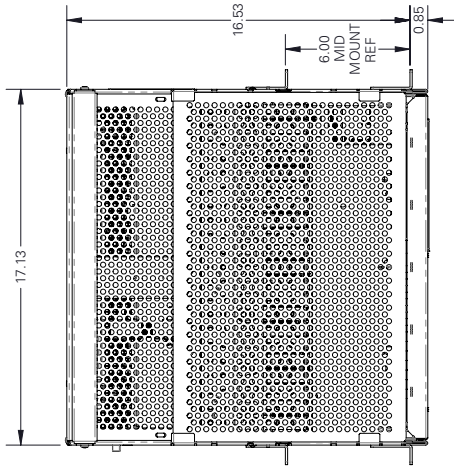

0250030-013  
 0250030-014  
 0250030-015  
 0250030-016

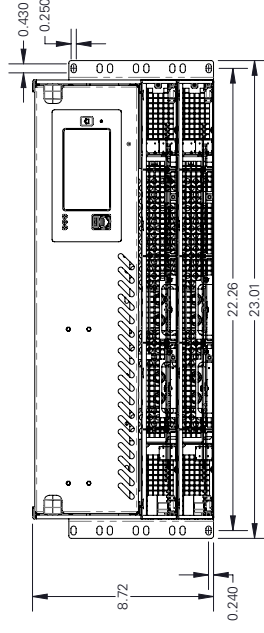

0250030-005  
 0250030-006  
 0250030-007  
 0250030-008

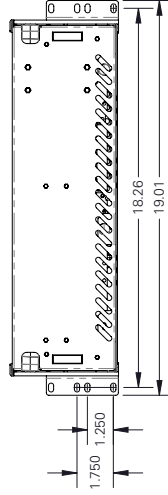
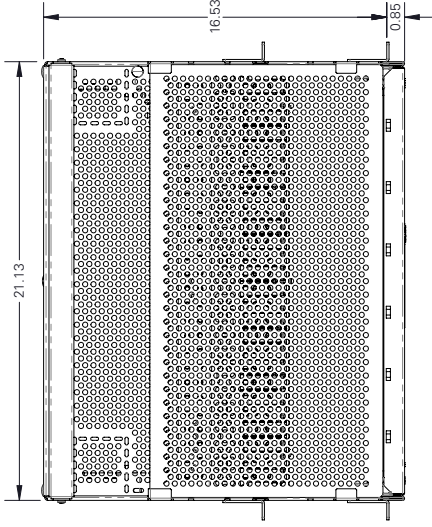
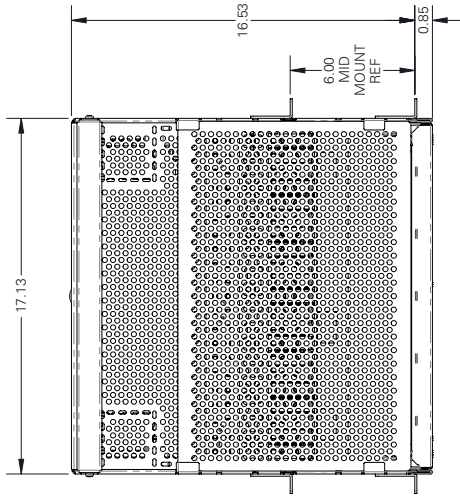

0250030-018  
 0250030-020

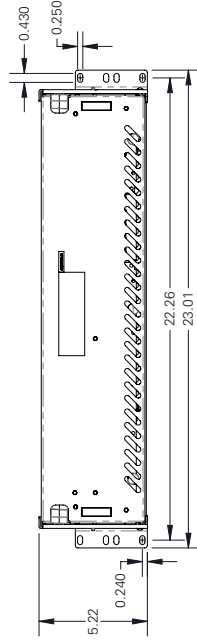

0250030-017  
 0250030-019



CORDEX® CXPS-E3 / CXDM-E3  
OUTLINE DRAWING

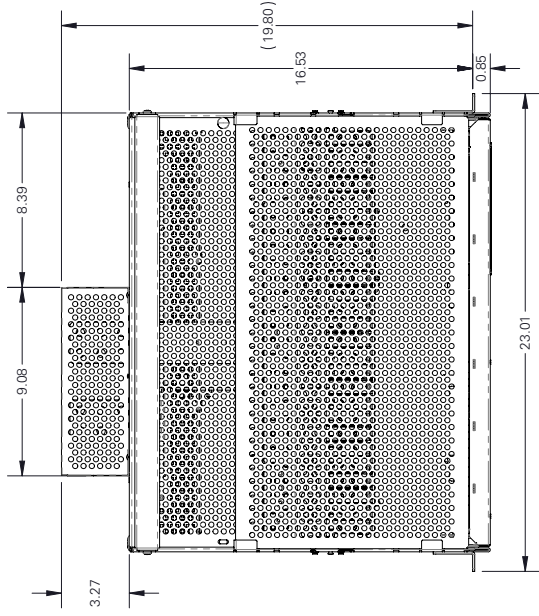
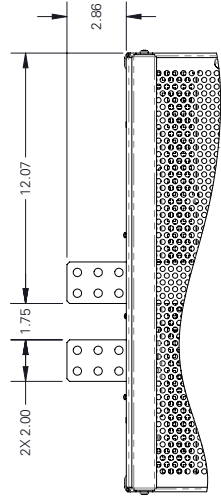

0250030-750  
23-inch

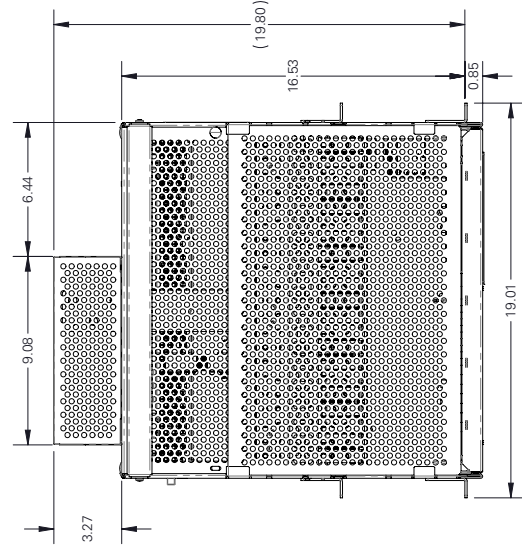
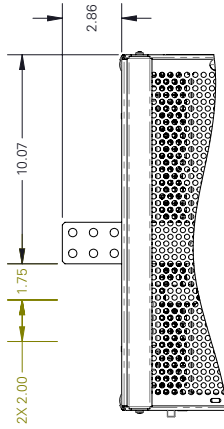

0250030-750  
19-inch

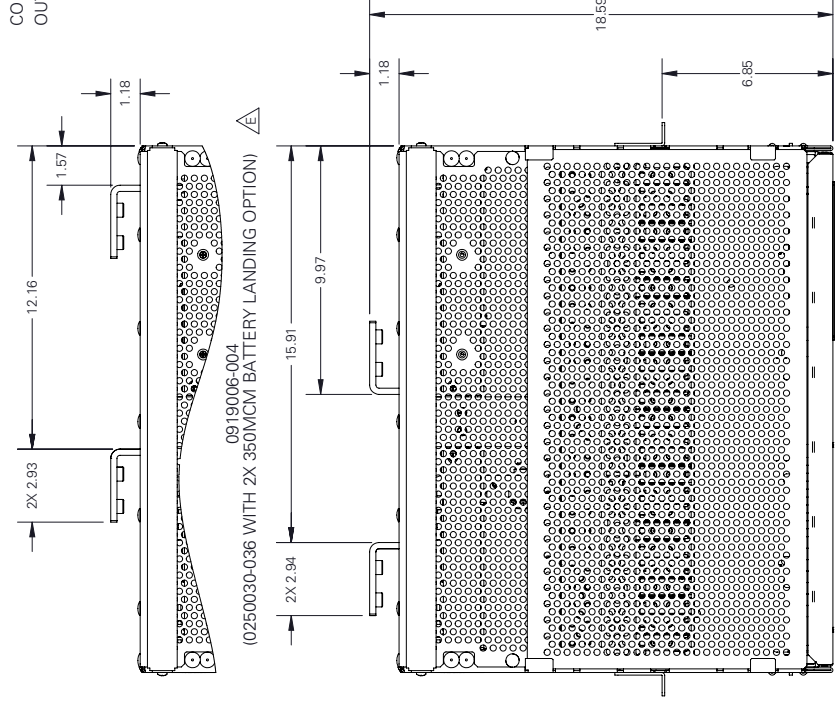
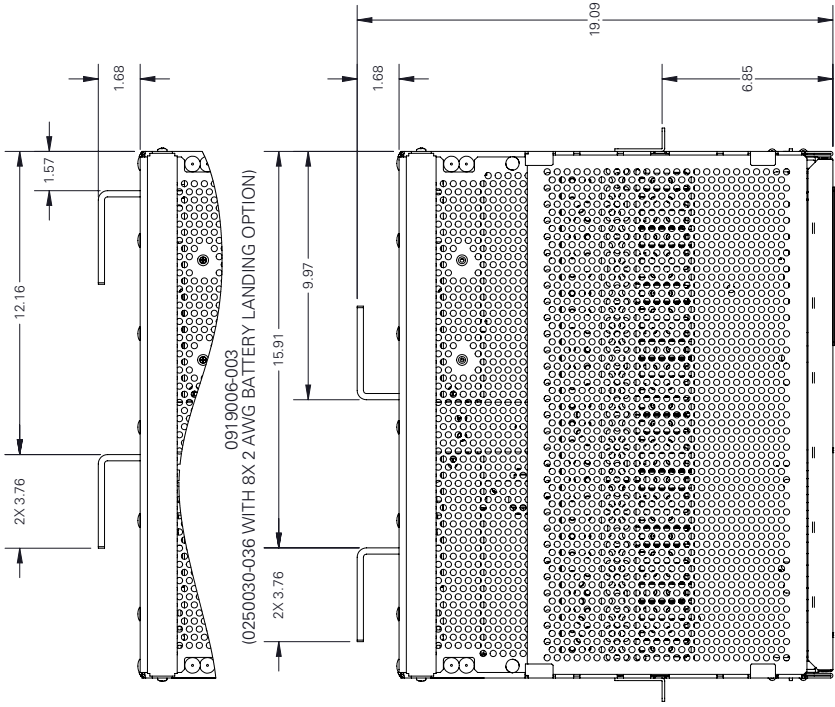

0919007-003  
(0250036-037 WITH 8X 2 AWG BATTERY LANDING OPTION)

0919007-004  
(0250036-037 WITH 2X 350MCM BATTERY LANDING OPTION)

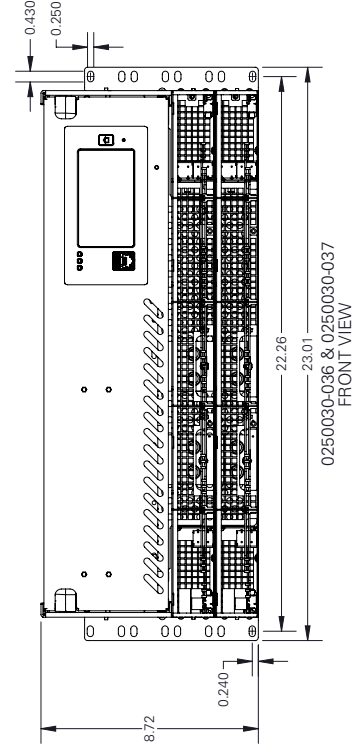

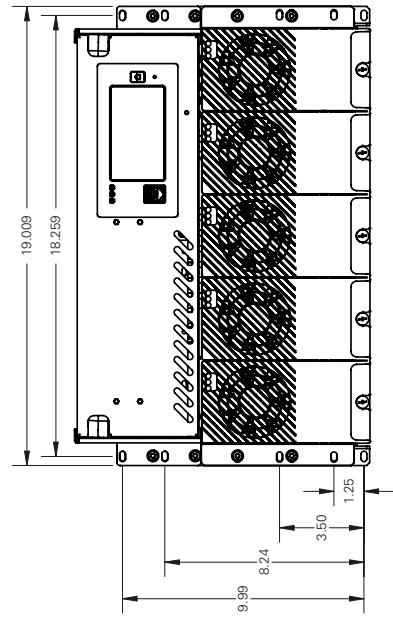
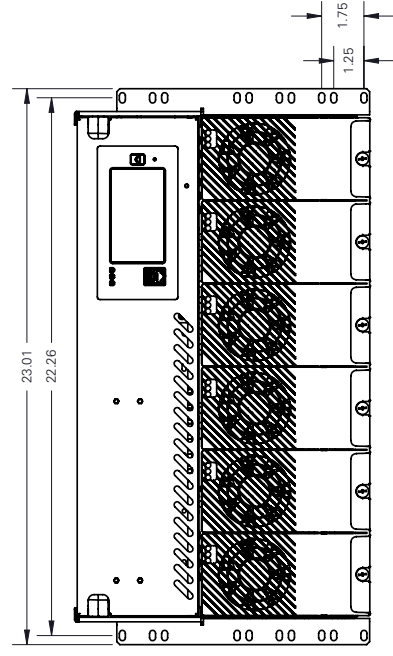
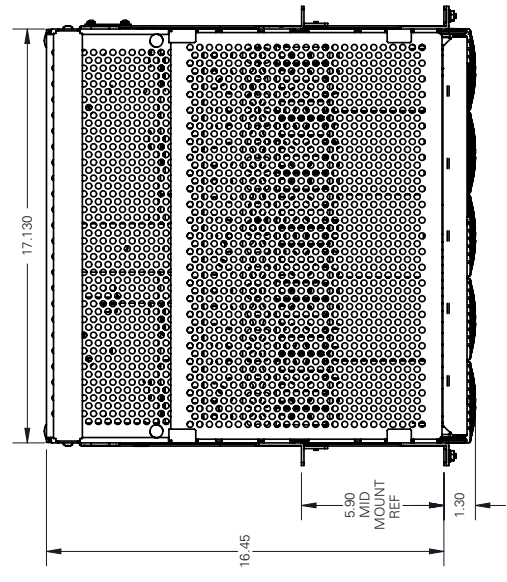
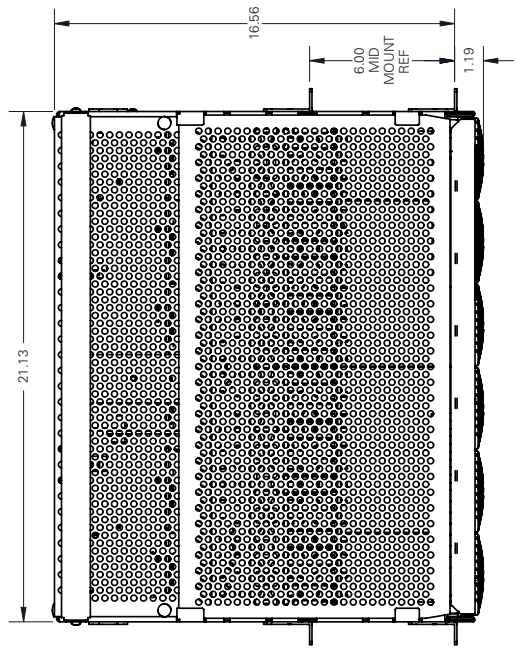

- 0250029-001
- 0250029-003
- 0250029-005
- 0250029-006
- 0250029-007
- 0250029-008

- 0250029-002
- 0250029-004



CORDEX® CXPS-E3 (4KW)  
CUSTOMER CONNECTIONS

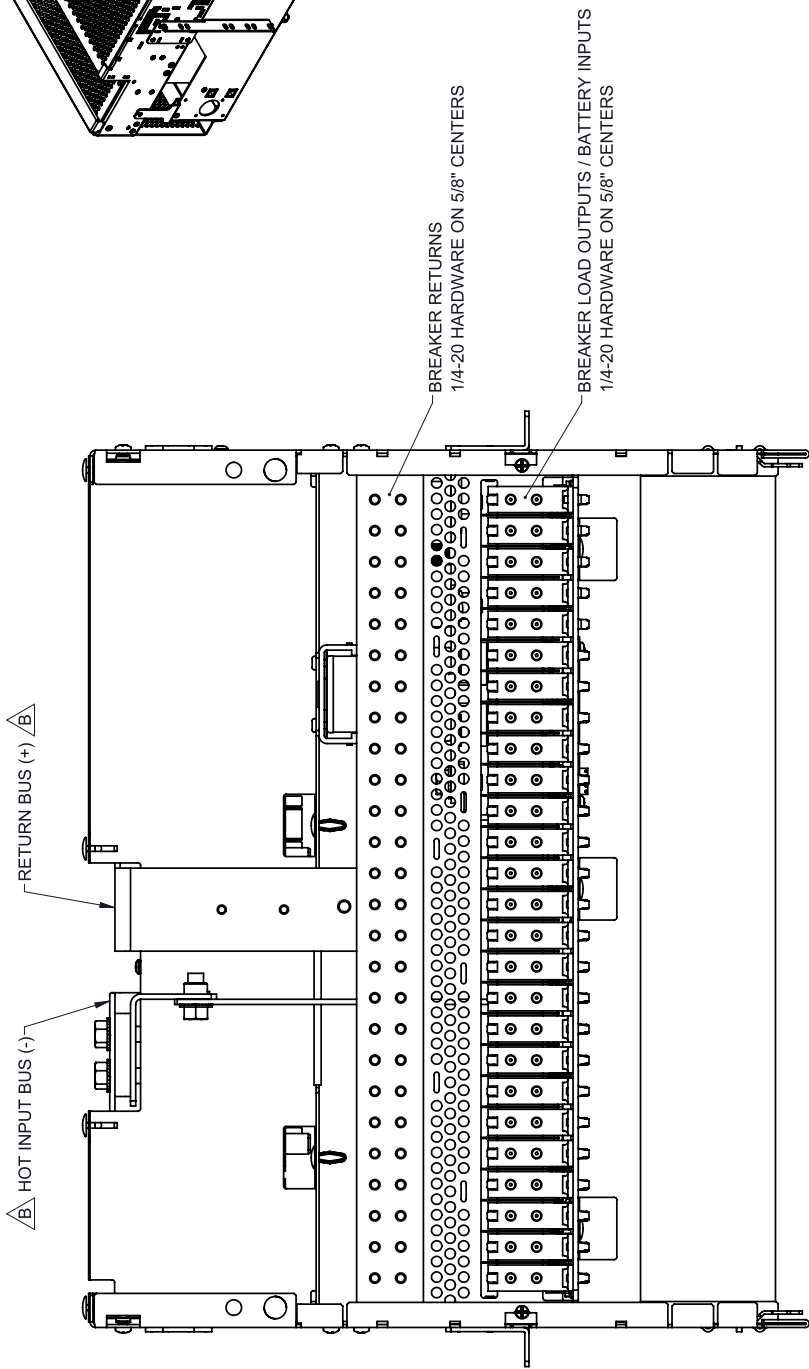
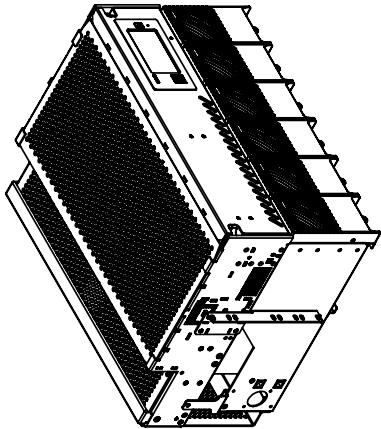

TOP VIEW  
DOOR, COVER AND DRESSER BAR REMOVED

CORDEX® CXPS-E3 (4KW)  
CUSTOMER CONNECTIONS

BATTERY & LOAD BREAKERS  
WHERE APPLICABLE (5 POSITIONS)

LOAD BREAKERS (21 / 16 POSITIONS)

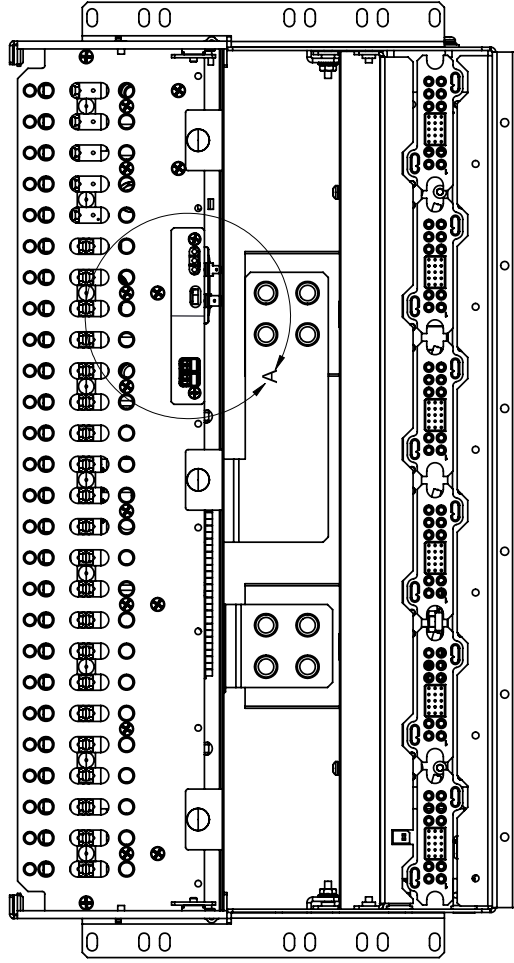

FRONT VIEW WITH DOOR REMOVED

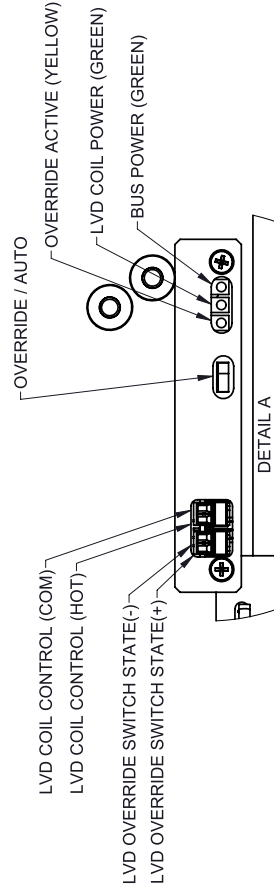
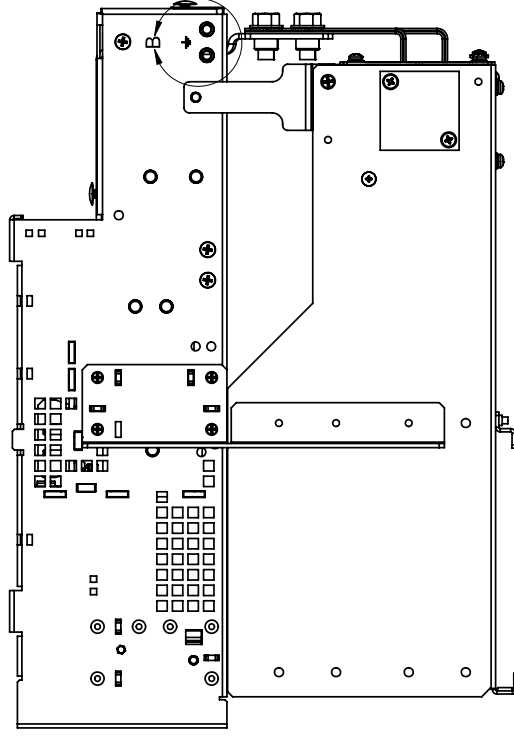

DETAIL A

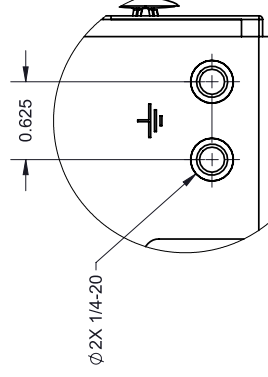

DETAIL B

CORDEX® CXP5-E3 (19- and 23-inch)  
CUSTOMER CONNECTIONS

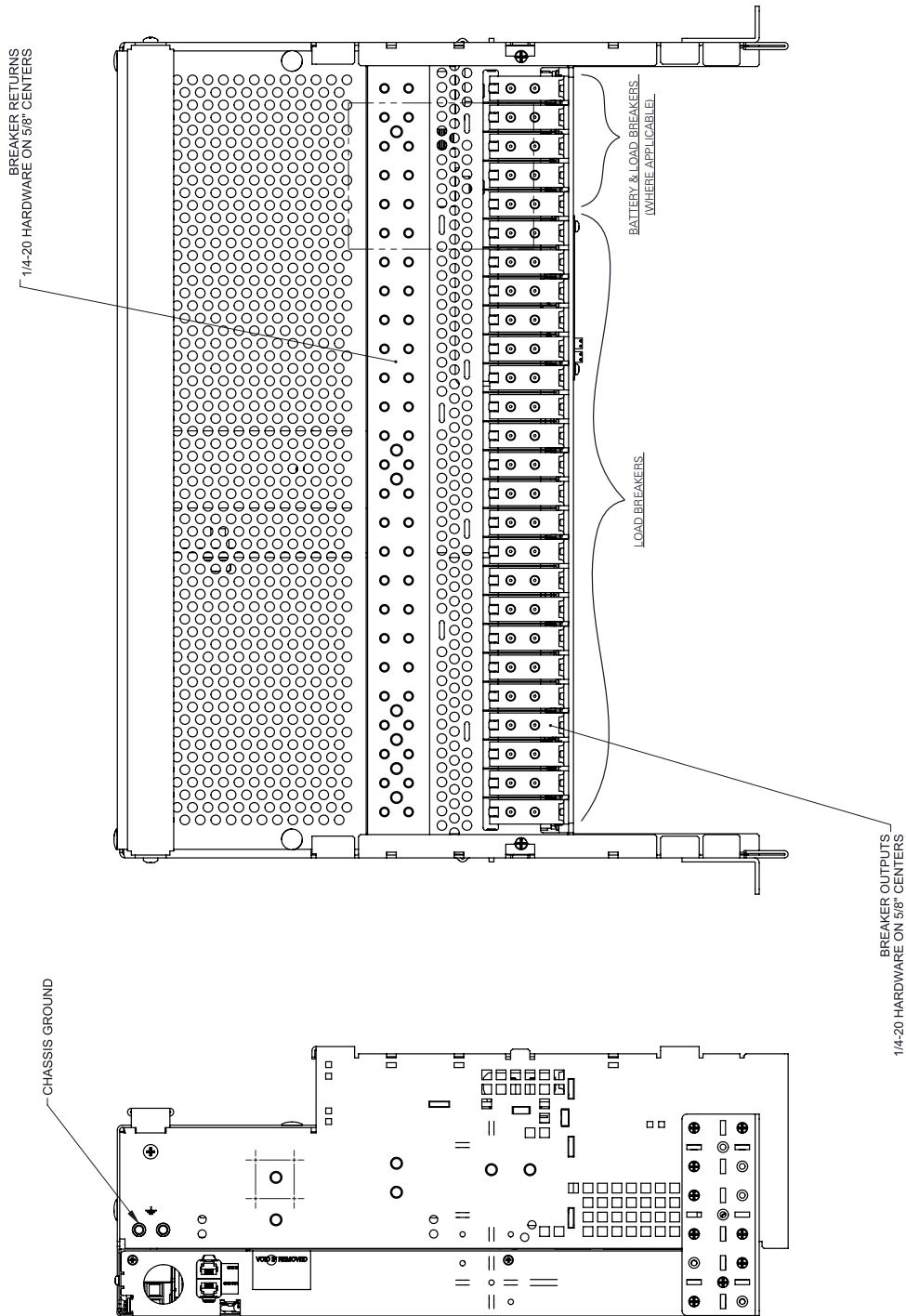

**LVD OVERRIDE BOARD**

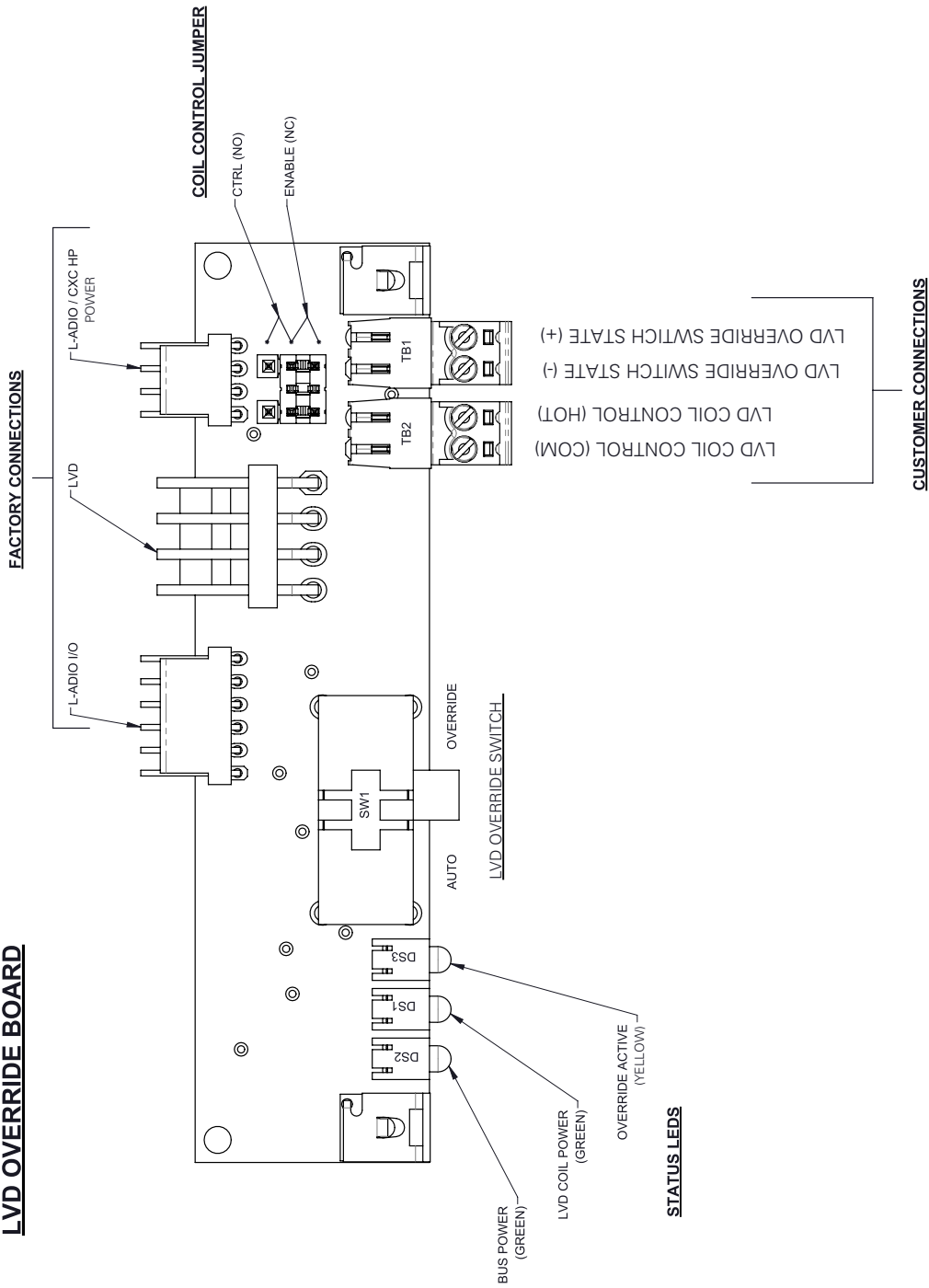

CORDEX® CXPS-E3 (19- and 23-inch)  
CUSTOMER CONNECTIONS

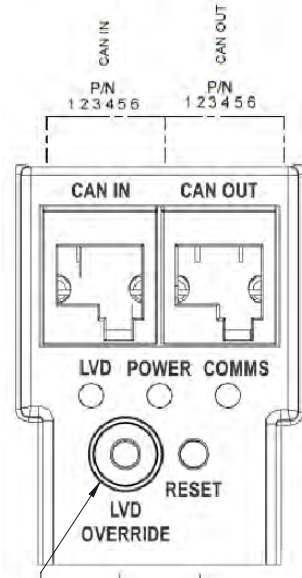

DO NOT USE.  
SEE MANUAL FOR LVD  
OVERRIDE INSTRUCTIONS

SOFTWARE  
LVD-OVERRIDE  
FUNCTION

SOFT-RESET



NOTES:

1. RELAY K1 RESERVED FOR LVD CONTROL (IF EQUIPPED).
2. RELAY K2 RESERVED FOR OPEN PANEL BREAKER / FUSE ALARMS.
3. RELAY K3 RESERVED FOR OPEN ALARM IF EQUIPPED.
4. RELAY K4 RESERVED FOR BATTERY / LOAD VOLTAGE MONITORING.
5. RELAY K5 RESERVED FOR BATTERY / LOAD SHUNT MONITORING.

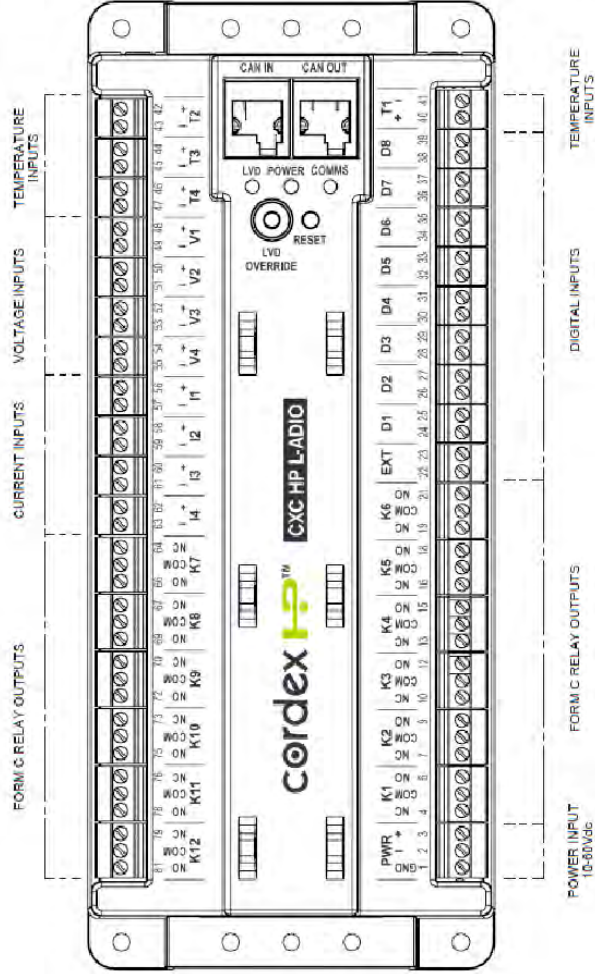

CXC-HP L-RADIO I/O MODULE

CORDEX® CXPS-E3 (19- and 23-inch)  
CUSTOMER CONNECTIONS

CXC HP CONTROLLER

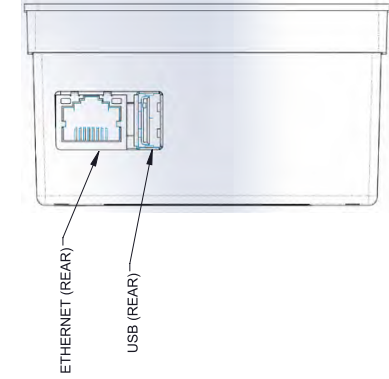
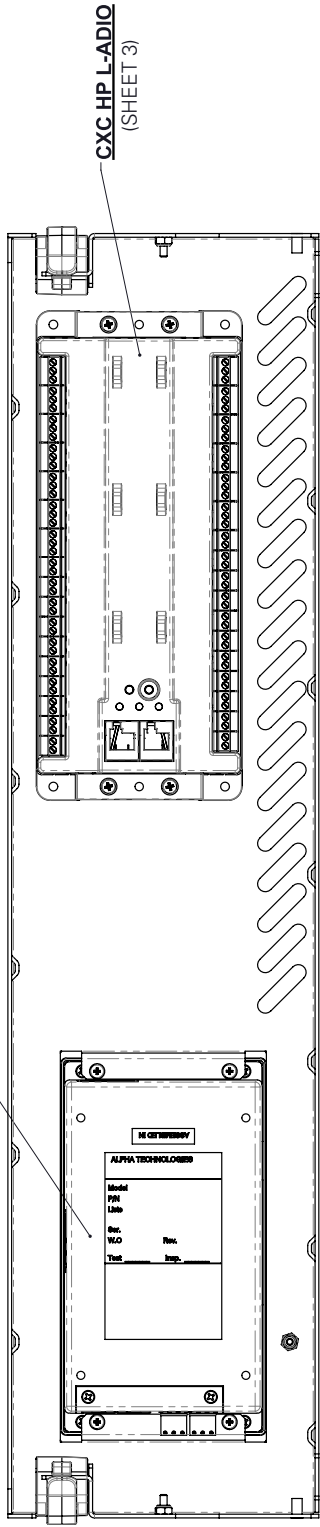

CXC HP CONTROLLER  
(LEFT SIDE)



CXC HP CONTROLLER  
(FRONT)

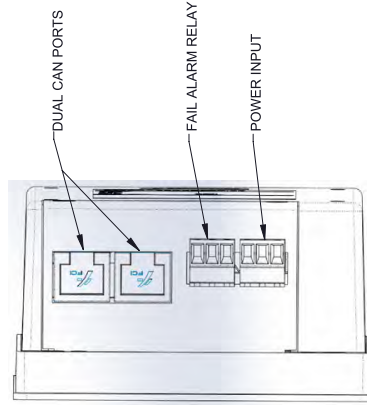

CXC HP CONTROLLER  
(RIGHT SIDE)





Alpha Technologies Ltd. | 7700 Riverfront Gate, Burnaby, BC V5J 5M4 Canada  
Toll Free North America: +1 800-667-8743 | Outside North America +1 604-436-5547 | Technical Support +1 888-462-7487  
For more information visit our website at [www.enersys.com](http://www.enersys.com)

© 2023 Alpha Technologies Ltd., an EnerSys company. All Rights Reserved. Trademarks and logos are the property of EnerSys and its affiliates except for ANSI®, CSA®, IEC®, IEEE®, NEC®, National Electrical Code®, NO-OX-ID®, Scotch-Brite®, UL®, and Underwriters Laboratories®, which are not the property of EnerSys. Subject to revisions without prior notice. E. & O.E.