



| an EnerSys® company

# Alpha Micro 100 UPS

Technical Guide: 017-220-J0

Effective: 09/2020





# Alpha<sup>®</sup> Micro 100 UPS

## Installation and Operation Manual

 **NOTE:**

---

**Photographs contained in this manual are for illustrative purposes only. These photographs may not match your installation.**

 **NOTE:**

---

**Operator is cautioned to review the drawings and illustrations contained in this manual before proceeding. If there are questions regarding the safe operation of this powering system, contact Alpha Technologies or your nearest Alpha representative.**

 **NOTE:**

---

**Alpha shall not be held liable for any damage or injury involving its enclosures, power supplies, generators, batteries, or other hardware if used or operated in any manner or subject to any condition inconsistent with its intended purpose, or if installed or operated in an unapproved manner, or improperly maintained.**

For technical support, contact Alpha Technologies:

Canada and USA: **1-888-462-7487**

International: **+1-604-436-5547**

## Copyright

Copyright © 2020 Alpha Technologies Ltd. All rights reserved. Alpha is a registered trademark of Alpha Technologies Services, Inc.

No part of this documentation shall be reproduced, stored in a retrieval system, translated, transcribed, or transmitted in any form or by any means manual, electric, electronic, electromechanical, chemical, optical, or otherwise without prior explicit written permission from Alpha Technologies.

This document, the software it describes, and the information and know-how they contain constitute the proprietary, confidential and valuable trade secret information of Alpha Technologies, and may not be used for any unauthorized purpose, or disclosed to others without the prior written permission of Alpha Technologies.

The material contained in this document is for information only and is subject to change without notice. While reasonable efforts have been made in the preparation of this document to assure its accuracy, Alpha Technologies assumes no liability resulting from errors or omissions in this document, or from the use of the information contained herein. Alpha Technologies reserves the right to make changes in the product design without reservation and without notification to its users.

# Table of Contents

1. Safety.....	7
1.1 Safety Symbols .....	7
1.2 Electrical Safety .....	8
1.3 General Warnings and Cautions .....	8
1.4 Certifications and Compliance .....	9
2. Introduction .....	10
2.1 Product Overview.....	10
3. Specifications.....	12
4. Site Planning.....	14
4.1 Safety Precautions .....	14
4.2 Electromagnetic Compatibility (EMC) Requirements .....	14
4.3 Mounting Options for the Alpha Micro 100 .....	14
5. Inspection.....	15
5.1 Packing Materials.....	15
5.2 Check for Damage .....	15
5.3 General Receipt of Shipment.....	15
6. Unpacking the Alpha® Micro 100.....	16
7. Installation.....	17
7.1 Transporting and Lifting.....	17
7.2 Mounting Options .....	17
7.3 Wiring the Alpha® Micro 100.....	21
7.4 Installing and Wiring the Batteries.....	22
8. Theory of Operation .....	27
8.1 Block Diagram.....	27
8.2 Modes of Operation.....	27
9. Operating the Alpha® Micro 100.....	31
9.1 Switching the Alpha Micro 100 On and Off .....	31
9.2 Operating Modes.....	32
9.3 Control Parameters .....	32

9.4	Battery Charging Options.....	34
9.5	Operating via the Communication Module (Intranet or Internet).....	37
9.6	Alpha UPS Monitor Interface: Communication via USB.....	58
9.7	HyperTerminal Interface.....	61
10.	Peukert Number.....	73
10.1	Introduction.....	73
10.2	Determining the Peukert Number.....	73
10.3	Using the Equation.....	74
10.4	Using the Spreadsheet.....	75
11.	Maintenance.....	76
11.1	Updating the Micro 100 Firmware (no Communication Module).....	76
11.2	Testing and Replacing the Batteries.....	78
11.3	Preventative Maintenance.....	80
12.	Troubleshooting.....	81
13.	Warranty and Service Information.....	82
13.1	Technical Support.....	82
13.2	Warranty Statement.....	82
13.3	Limited Hardware Warranty.....	82
13.4	Battery Warranty.....	82
13.5	Warranty Claims.....	82
13.6	Service Centers.....	82
14.	Emergency Shutdown Procedure.....	83

# List of Figures

- Figure 1 — Alpha Micro 100, Front View (Without Door) ..... 10
- Figure 2 — Output Connectors and Monitoring LEDs (Bottom View) ..... 10
- Figure 3 — Front Panel.....11
- Figure 4 — Wall mounting template ..... 18
- Figure 5 — Mounting to a wooden pole ..... 19
- Figure 6 — Mounting to a steel or concrete pole ..... 20
- Figure 7 — Wiring the Alpha Micro 100 ..... 22
- Figure 8 — Battery Locations and Wiring ..... 23
- Figure 9 — Micro 100 block diagram ..... 27
- Figure 10 — Battery charging in utility mode ..... 29
- Figure 11 — Back up power from batteries ..... 29
- Figure 12 — LED status Indicators ..... 30
- Figure 13 — Bulk Charging Parameters ..... 34
- Figure 14 — Web Interface: Bulk Charging Menus..... 35
- Figure 15 — Web Interface: Bulk Charging Menus..... 36
- Figure 16 — Web Interface: UPS Specification Screen shown ..... 37
- Figure 17 — Communications Screen ..... 38
- Figure 18 — UPS Specification Screen ..... 39
- Figure 19 — UPS Monitoring: Input and Output Screen ..... 40
- Figure 20 — UPS Monitoring: Battery and Inverter Screen—Standard Charging ..... 40
- Figure 21 — Web GUI: Relay and Load Shed screen ..... 41
- Figure 22 — UPS Monitoring: Power Outages ..... 41
- Figure 23 — UPS Maintenance: Unit Configuration screen..... 42
- Figure 24 — Restore all default commands..... 42
- Figure 25 — UPS Maintenance: Battery Screen..... 44
- Figure 26 — UPS Maintenance: Inverter Screen..... 45
- Figure 27 — UPS Maintenance: Relay and Load Shed Screen ..... 46
- Figure 28 — Programmable Timer Operation ..... 47
- Figure 29 — Time Of Day Action Operation..... 47

Figure 30 — Time Of Day Configuration .....	48
Figure 31 — Time Of Day Action Status .....	48
Figure 32 — UPS Maintenance: Time and Date Screen.....	49
Figure 33 — UPS Maintenance: Password Screen .....	49
Figure 34 — Power Outage Configuration.....	50
Figure 35 — Alarms and Faults Screen .....	51
Figure 36 — Event History Screen.....	51
Figure 37 — Event Manager > All Events .....	52
Figure 38 — Event Manager > Export Events .....	52
Figure 39 — Alpha Web Interface: Upgrade Firmware .....	53
Figure 40 — Upgrade Communication Module.....	53
Figure 41 — Site Information .....	53
Figure 42 — Configure SNMP Screen .....	54
Figure 43 — Email Notification Screen .....	54
Figure 44 — Test Email Feature .....	55
Figure 45 — Keep Alive Feature .....	56
Figure 46 — Alpha UPS Monitor (UPS Specification Screen shown).....	58
Figure 47 — Add or Remove Programs Window .....	59
Figure 48 — Event Log Monitor, Open Event File window.....	60
Figure 49 — Sample Event Log, Displayed in the UPS Monitor.....	60
Figure 50 — HyperTerminal Communication Parameters.....	61
Figure 51 — Main Menu Screen .....	62
Figure 52 — Menu Tree .....	63
Figure 53 — Battery String Example.....	74
Figure 54 — Typical Discharge Characteristics for Lead Acid Batteries .....	78

# 1. Safety

---

**SAVE THESE INSTRUCTIONS:** This manual contains important safety instructions that must be followed during the installation, servicing, and maintenance of the product. Keep it in a safe place. Review the drawings and illustrations contained in this manual before proceeding. If there are any questions regarding the safe installation or operation of this product, contact Alpha Technologies or the nearest Alpha representative. Save this document for future reference.

## 1.1 Safety Symbols

To reduce the risk of injury or death, and to ensure the continued safe operation of this product, the following symbols have been placed throughout this manual. Where these symbols appear, use extra care and attention.

The use of ATTENTION indicates specific regulatory/code requirements that may affect the placement of equipment and /or installation procedures.



### NOTE:

**A NOTE provides additional information to help complete a specific task or procedure. Notes are designated with a check mark, the word NOTE, and a rule beneath which the information appears.**



### CAUTION!

**CAUTION indicates safety information intended to PREVENT DAMAGE to material or equipment. Cautions are designated with a yellow warning triangle, the word CAUTION, and a rule beneath which the information appears.**



### WARNING!

**WARNING presents safety information to PREVENT INJURY OR DEATH to personnel. Warnings are indicated by a shock hazard icon, the word WARNING, and a rule beneath which the information appears.**



### HOT!

**The use of HOT presents safety information to PREVENT BURNS to the technician or user.**



### HOT!

**The use of HOT symbol (ISO 8005) on the product indicates a potential burn hazard to the technician or to the user.**



## 1.2 Electrical Safety



### WARNING!

**WARNING: Risk of electric shock. Hazardous live parts inside this UPS are energized from the battery supply even when input AC power is disconnected. Do not remove cover. No user serviceable parts inside. Refer servicing to qualified service personnel. Use only the supplied batteries with the unit.**

- To be installed by qualified service personnel only, in accordance with applicable local and/or state electrical codes, including consideration of a dedicated grounding rod.
- CAUTION: Use wires suitable for at least 90° C.
- In order to comply with the Canadian electrical code part 1, the UPS must receive power from a disconnect marked suitable for use as service equipment.
- This equipment has been evaluated to Over Voltage Category (OVC) CAT II. If the equipment is intended to be used in areas where the OVC can exceed the design, then additional protection is to be provided external to the equipment in the end installation

## 1.3 General Warnings and Cautions

You must read and understand the following warnings before installing the Alpha Micro 100 and its components. Failure to do so could result in personal injury or death.

- Read and follow all instructions included in this manual.
- Do not work alone under hazardous conditions.
- Only qualified personnel are allowed to install, operate and service this system and its components.
- Use proper lifting techniques whenever handling equipment, parts, or batteries.
- Always assume electrical connections or conductors are live. Switch off all circuit breakers and double-check connections with a voltmeter before performing installation or maintenance.
- Place warning label(s) on the utility panel to tell emergency personnel a UPS is installed.
- The Alpha Micro 100 uses more than one live circuit. AC power may be present at the outputs even if the system is disconnected from line or battery power.
- Battery installation and servicing should be done or supervised by personnel knowledgeable about batteries and their safety procedures.
- Be extra cautious when connecting or adjusting battery cabling. An improperly connected battery cable or an unconnected battery cable can result in arcing, fire, or explosion.
- Use new batteries when installing a new unit. Verify that all batteries are the same type with identical date codes.
- Always replace batteries with ones of identical number, type and rating. Never install old or untested batteries. One sealed lead-acid battery is rated to a maximum voltage of 12Vdc.
- A battery that shows signs of cracking, leaking or swelling must be replaced immediately by authorized personnel using a battery of identical type and rating.
- Keep tools away from walk areas where you or others could fall over them.
- Wear safety glasses when working under any conditions that might be hazardous to your eyes.
- Do not work on the unit or connect or disconnect cables during periods of lightning activity.
- Do not smoke or introduce sparks in the vicinity of a battery.
- Never open or damage the batteries. Released electrolyte is harmful to the skin and eyes. It may be toxic and hazardous to the environment.

- A battery can present a risk of electrical shock and high short-circuit current. The following precautions should be observed when working on batteries:
  - a. Remove watches, rings, or other metal objects.
  - b. Use tools with insulated handles.
  - c. Wear rubber gloves and boots.
  - d. Do not lay tools or metal parts on top of batteries.
  - e. Disconnect the charging source before connecting or disconnecting battery terminals.
  - f. Determine if the battery is inadvertently grounded. If inadvertently grounded, remove the source from the ground. Contact with any part of a grounded battery can result in electrical shock. The likelihood of such shock can be reduced if the grounds are removed during installation and maintenance (applicable to equipment and remote battery supplies not having a grounded supply circuit).
- Never let live battery wires touch the Alpha Micro 100 enclosure or any other metal objects. This can cause a fire or explosion.
- Never dispose of batteries in a fire. The batteries may explode. Follow the manufacturer's directions and check with your local jurisdictions for safe battery disposal.
- Before attaching the batteries to the Alpha Micro 100 make sure that the polarity is correct.
- If the batteries have been in storage for more than six months at 25°C, recharge them for at least 24 hours and then test them with a load before installation.
- Each battery has a date code, found on the warning label, which must be recorded in the maintenance log. If non-Alpha batteries are used, see the manufacturer's documentation for date code type and placement.

## 1.4 Certifications and Compliance

The Alpha Micro 100 has been designed, manufactured, and tested to the requirements of the following national and international safety standards:

Safety:	UL 1778; CSA C22.2 107.3; EN 62040-1* (*applies to 230Vac units only)
EMC:	FCC Part 15, Subpart B Class A; ICES-003 Class A; EN 62040-2 Class A* (*applies to 230Vac units only)

This equipment has been tested and found to comply with the limits for a Class A digital device pursuant to part 15 of the FCC Rules. These limits are designed to provide reasonable protection against harmful interference when the equipment is operated in a commercial environment. This equipment generates, uses, and can radiate radio frequency energy and, if not installed and used in accordance with the instruction manual, may cause harmful interference to radio communications. Operation of this equipment in a residential area is likely to cause harmful interference in which case the user will be required to correct the interference at his own expense.

## 2. Introduction

### 2.1 Product Overview

The Alpha<sup>®</sup> Micro 100 UPS is designed to provide up to 100W of uninterrupted AC power to the load.

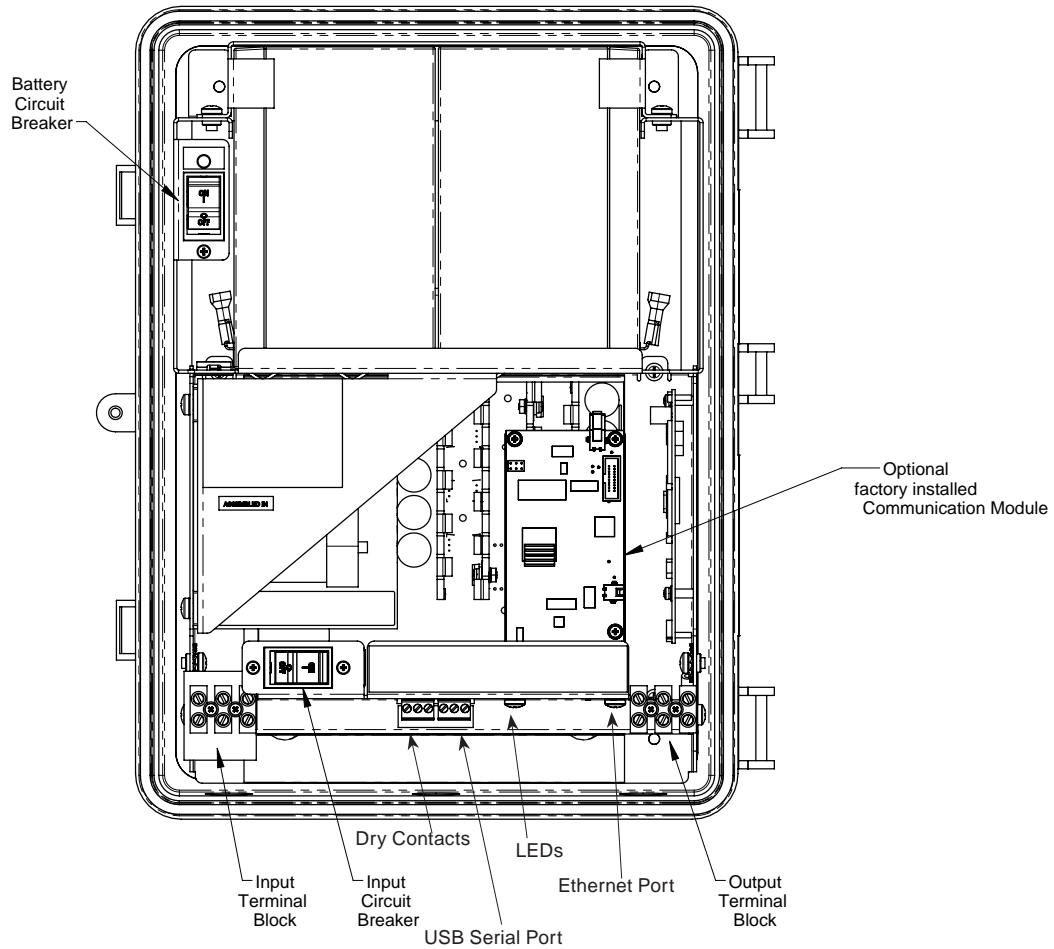

Figure 1 — Alpha Micro 100, Front View (Without Door)

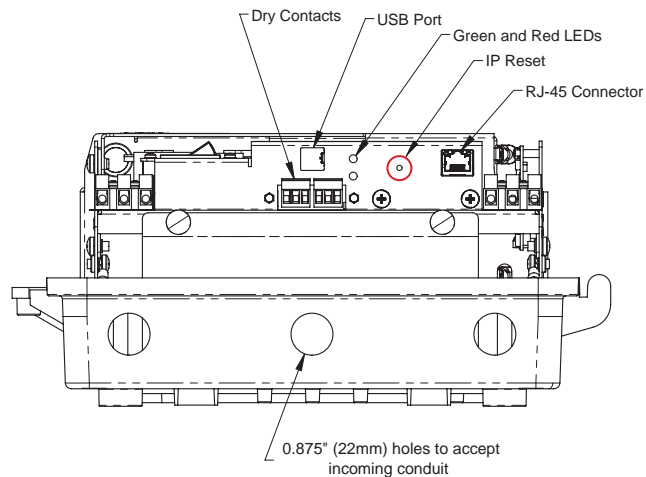
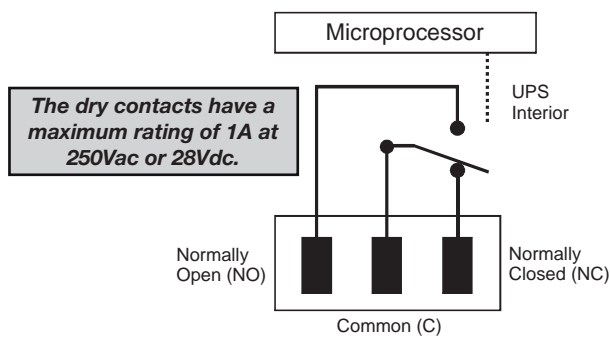
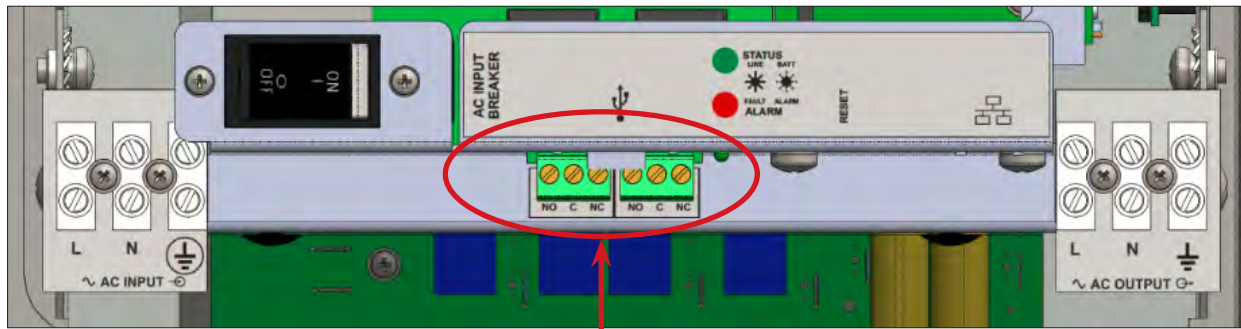

Figure 2 — Output Connectors and Monitoring LEDs (Bottom View)

The Alpha Micro 100 conditions the utility input to provide regulated AC voltage at the output. While the utility is present, the Alpha Micro 100 keeps the batteries fully charged. In the event of a utility failure, the Alpha Micro 100 continues to power the loads using the energy stored in the batteries until they are depleted to low battery disconnect level.

The Alpha Micro 100 comes standard with a USB-B serial port for on site communications. The unit configuration and be modified and operating conditions monitored.

The front panel contains two status LEDs and two dry contacts for external status monitoring. The Alpha Micro 100 also comes with an optional communications module for remote monitoring.



- C1 is the “On Batt” contact, triggered when the UPS is in Backup mode and battery power is provided to the load.
- C2 is the “Low Batt” contact, triggered when the battery voltage falls below a pre-programmed setting.
- The functionality of these contacts can be changed from these factory defaults, see "Table Q — Dry Contact Configuration Settings" on page 67. for more details.

Figure 3 — Front Panel

### 3. Specifications

<b>Table A — Mechanical Specifications</b>	
<b>Parameter</b>	<b>Value</b>
<b>Dimensions H x W x D mm (in)</b>	Std: 381 (15) x 305 (12) x 153 (6)
<b>Weight kg (lb)</b>	22.7 (50) with 4 batteries 11.3 (25) without batteries
<b>Mounting</b>	Wall or pole (with optional bracket Alpha Kit # 740-751-21)
<b>Humidity</b>	Operating: non-condensing up to 95% RH Storage: up to 95% RH
<b>Temperature, °C Operating Storage</b>	–40 to 50°C (–40 to 122°F) –40 to 75°C (–40 to 167°F)
<b>Altitude, m (ft) Operating Storage</b>	Up to 3700 (12,000) Up to 4600 (15,000)
<b>AC input and output connectors</b>	3-position terminal block (maximum 12 AWG)
<b>Dry contact ATC connectors</b>	Terminal block, mating plug JITE p/n PTB750B-03-1-03-3 or equivalent (max 16 AWG)
<b>USB connector</b>	USB B
<b>Ethernet connector</b>	Optional, factory installed RJ-45
<b>Dry contacts</b>	Two programmable dry, single pole double-throw relays (C, NO/NC). Contacts are rated at 28Vdc or 250Vac, 1A. The factory default settings are: C1: On battery, C2: Low battery
<b>Displays</b>	Two LEDs (1 red and 1 green) via dry contact board
<b>Enclosure Environmental Protection Rating</b>	Type 3R Enclosure (Equivalent to IP53)

<b>Table B — Electrical Specifications</b>	
<b>Parameter</b>	<b>Value</b>
<b>Input</b>	
<b>Voltage (nominal), Vac</b>	120 or 230
<b>Frequency, Hz, ±3 Hz</b>	60/50 (auto-frequency)
<b>Current, A</b>	2.0 @ 120Vac 1.0 @ 220/230Vac
<b>Input circuit breaker</b>	3.0A, 125Vac 1.5A, 230Vac
<b>Output</b>	
<b>Voltage (nominal), Vac</b>	120 or 230 (± 10% on line mode, ± 2% on inverter mode)
<b>Frequency, Hz, ±5%</b>	60/50 (auto-frequency)
<b>Current, A</b>	0.83 @ 120Vac 0.43 @ 230Vac
<b>Power, W/VA</b>	100
<b>Waveform</b>	Sine wave
<b>Load Crest Factor</b>	3:1 (load dependent)
<b>Output Voltage Distortion</b>	< 3% THD (resistive load)
<b>Efficiency Utility Mode Backup (Inverter) Mode</b>	> 85% > 75%

<b>Table B – Electrical Specifications</b>	
<b>Parameter</b>	<b>Value</b>
<b>Transfer Time, ms</b> <b>AVR to Backup</b> <b>Backup to AVR</b>	5 (Typical) 3 (Typical)
<b>Line Qualification Time, s</b>	3 (default)
<b>Battery String Voltage</b>	24
<b>Battery Charger Current</b> <b>(Factory default, A)</b>	3
<b>Battery Charger Temperature Compensation</b>	-5mV / °C / Cell (factory default), user adjustable to -2.5, -4, -5 and -6mV / °C / Cell
<b>Battery size</b>	4x 12Vdc (7.2Ah or 9Ah)
<b>Other</b>	
<b>Battery circuit breaker</b>	10A

<b>Table C – Boost/Buck/Line Transfer Thresholds</b>		
<b>Parameter</b>	<b>Value</b>	
	<b>Alpha Micro 100</b>	
	<b>120 VAC Units</b>	<b>230 VAC Units</b>
<b>Buck 1 to INV</b> <b>INV to Buck 1</b>	151 VAC 146 VAC	N/A N/A
<b>Buck 2 to INV</b> <b>INV to Buck 2</b>	N/A N/A	325 VAC 314 VAC
<b>Buck 1 to Buck 2</b> <b>Buck 2 to Buck 1</b>	N/A N/A	281 VAC 275 VAC
<b>Line to Buck 1</b> <b>Buck 1 to Line</b>	131 VAC 126 VAC	250 VAC 244 VAC
<b>Boost 1 to Line</b> <b>Line to Boost 1</b>	116 VAC 112 VAC	214 VAC 209 VAC
<b>Boost 2 to Boost 1</b> <b>Boost 1 to Boost 2</b>	102 VAC 98 VAC	186 VAC 180 VAC
<b>INV to Boost 2</b> <b>Boost 2 to INV</b>	92 VAC 87 VAC	163 VAC 158 VAC

<b>Table D – Regulatory</b>	
<b>Parameter</b>	<b>Value</b>
<b>Electrical Safety</b>	UL 1778, CSA 22.2 107.3, EN62040-1
<b>Emission</b>	FCC Part 15, Subpart B, Class A, ICE-003, Class A EN62042-2* (* 230V models only)
<b>Marks</b>	cCSAus (120V models), CE (230V models)
<b>Packaging</b>	Designed to meet requirements for ISTA program.
<b>RoHS</b>	Yes, *Batteries exempt as per Directive 2006/66/EC

## Radio Frequencies

The Alpha Micro 100 generates, uses and radiates radio frequencies if not installed and tested in accordance with the instructions in this manual. It has been tested and found to comply with the limits established for a Class A computing device pursuant to part 15 of FCC rules and CISPR 22 when it is operated alone. It also complies with the radio interference regulations of DOC which are designed to provide reasonable protection against such interference to radio to TV reception, which is determined by switching it on and off, relocate the equipment or use an electrical circuit other than the one used by the Alpha Micro 100.

## 4. Site Planning

---



### WARNING!

The Alpha® Micro 100 must be installed in a restricted access area accessible only by qualified service personnel.

The Alpha Micro 100 must be correctly grounded for proper operation according to local and national electrical code.

The utility line attached to the Alpha Micro 100 input **MUST** be protected by a circuit breaker certified for this use in accordance with the local electrical code.

The AC input and AC output must each have a disconnect device attached. This device can be a listed branch circuit protection device or a disconnect switch used on AC Line only. Neutral or ground must never be disconnected by the user except during installation or maintenance.

### 4.1 Safety Precautions

Install the Alpha Micro 100 in a restricted access location, and on a structure that supports the total weight.

### 4.2 Electromagnetic Compatibility (EMC) Requirements

Observe the following EMC requirements when setting up the Alpha Micro 100 and its internal equipment:

- All AC wiring, Ethernet and dry contact cables must be rated for outdoor application as specified by local, national, and/or other applicable government codes and regulations.
- The customer facilities must provide suitable surge protection.
- Liquid tight fitting for AC input/output is for cable with outside diameter range 6.6 - 13.8mm (0.26" - 0.545").
- Liquid tight fitting for network/dry contacts cable can accommodate maximum 3 cables, outside diameter range 4 -6.5mm (0.16" - 0.255").

### 4.3 Mounting Options for the Alpha Micro 100

Choose from the following options for mounting the Alpha Micro 100:

- Mounting to a wall, see "7.2.1 Mounting to a Wall" on page 18.
- Mounting to a wooden pole, see "7.2.2 Mounting to a Wooden Pole (optional)" on page 19.
- Mounting to a steel or concrete pole, see "7.2.3 Mounting to a Steel or Concrete Pole" on page 20.

# 5. Inspection







## 5.1 Packing Materials

Alpha is committed to providing products and services that meet our customers' needs and expectations in a sustainable manner, while complying with all relevant regulatory requirements. As such Alpha strives to follow our quality and environmental objectives from product supply and development through to the packaging for our products.

Rectifiers and batteries are shipped on individual pallets and are packaged according to the manufacturer's guidelines.

Almost all of Alpha's packaging material is from sustainable resources and/or is recyclable. See the following table for the material and its environmental codes.

### 5.1.1 Returns for Service

 PAP/PCB	 PET	 PE-LD	 PS	 FE	 ALU	 NW
<b>Cardboard</b>	<b>Polyethylene Terephthalate</b>	<b>Low Density Polyethylene</b>	<b>Polystyrene</b>	<b>Steel</b>	<b>Aluminum</b>	<b>Wood</b>
Packing boxes Caps	Flexible film Packaging	Bubble wrap Shrink wrap Plastic bags	Foam	Strapping on pallets	Strapping on pallets	Pallets Lumber

Save the original shipping container. If the product needs to be returned for service, it should be packaged in its original shipping container. If the original container is unavailable, make sure that the product is packed with at least three inches of shock-absorbing material to prevent shipping damage.

Alpha Technologies is not responsible for damage caused by improper packaging of returned products.

## 5.2 Check for Damage

Before unpacking the product, note any damage to the shipping container. Unpack the product and inspect the exterior for damage. If any damage is observed, contact the carrier immediately.

Continue the inspection for any internal damage. In the unlikely event of internal damage, inform the carrier and contact Alpha Technologies for advice on the impact of any damage.

## 5.3 General Receipt of Shipment

The inventory included with your shipment depends on the options you have ordered. The options are clearly marked on the shipping container labels and bill of materials.

Call Alpha Technologies if you have any questions before you proceed: 1 888 462-7487.



# 6. Unpacking the Alpha<sup>®</sup> Micro 100

Follow these guidelines for unpacking the Alpha Micro 100.



## WARNING!

**The Alpha Micro 100 is heavy, more than 22.7 kg (50 lb) with batteries. Use proper lifting techniques. The lifting and moving should be done by at least two people to avoid injury.**

1. Select a suitable area for unpacking.
2. Store all the packing material and boxes for possible equipment returns.
3. Check the contents in your product package.
4. Compare the packing slip and the list of parts with the items you received. If the list of parts on your packing slip does not match the items you received, or any items appear damaged, immediately notify your carrier agent and the supplier who prepared your shipment.

### 6.3.1 Checking the Package Contents

Before starting the installation, inspect the package contents and make sure the following standard items as well as purchased options are included.

Quantity	Item
1	Alpha Micro 100 UPS module
1	Alpha Micro 100 mounting Kit (includes 2X screws and 2X nuts)
4	Batteries
4	Phillips head wood screws
2	Battery Interconnect kit
3	Liquid tight fittings
1	Alpha Micro 100 Installation and Operation Manual

Quantity	Item
1	Alpha Micro 100 pole/wall mounting kit

Call Alpha Technologies if you have any questions before you proceed: 1-888-462-7487.

# 7. Installation

---

The Alpha® Micro 100 can be installed on a wall or a pole. Once this decision is made, additional mounting accessories may be needed to proceed with your installation.

Once the installation location has been planned and prepared. There are three steps to installing the Alpha Micro 100.

1. Mounting the Alpha Micro 100.
2. Wiring the Alpha Micro 100.
3. Installing and wiring the batteries.

## 7.1 Transporting and Lifting



### WARNING!

**To avoid personal injury or damage to the equipment, always use at least two installation personnel to remove the unit from its container.**

**Batteries must not be installed until the Alpha Micro 100 enclosure has been securely set in place at its permanent location. Transporting the unit with batteries installed may cause a short circuit, fire, explosion, and/or damage to the battery pack, enclosure and installed equipment. Damage caused by improper shipping or transporting a unit with batteries installed is not covered by the warranty.**

## 7.2 Mounting Options

Choose any of the three mounting options:

- Mounting to a wall
- Mounting to a wooden pole
- Mounting to a steel/concrete pole

## 7.2.1 Mounting to a Wall

The Alpha Micro 100 can be mounted to a wall or to wall studs. The wall or studs should be able to hold a weight of at least 22.7 kg (50 lb). Use appropriate tools to ensure that the Alpha Micro 100 is installed level to the floor 2 pole/wall.

Using the Alpha Micro 100 case as a template, secure the case to the wall with the four Phillips-head wood screws supplied with the unit. If mounting on a concrete wall use surface appropriate hardware.

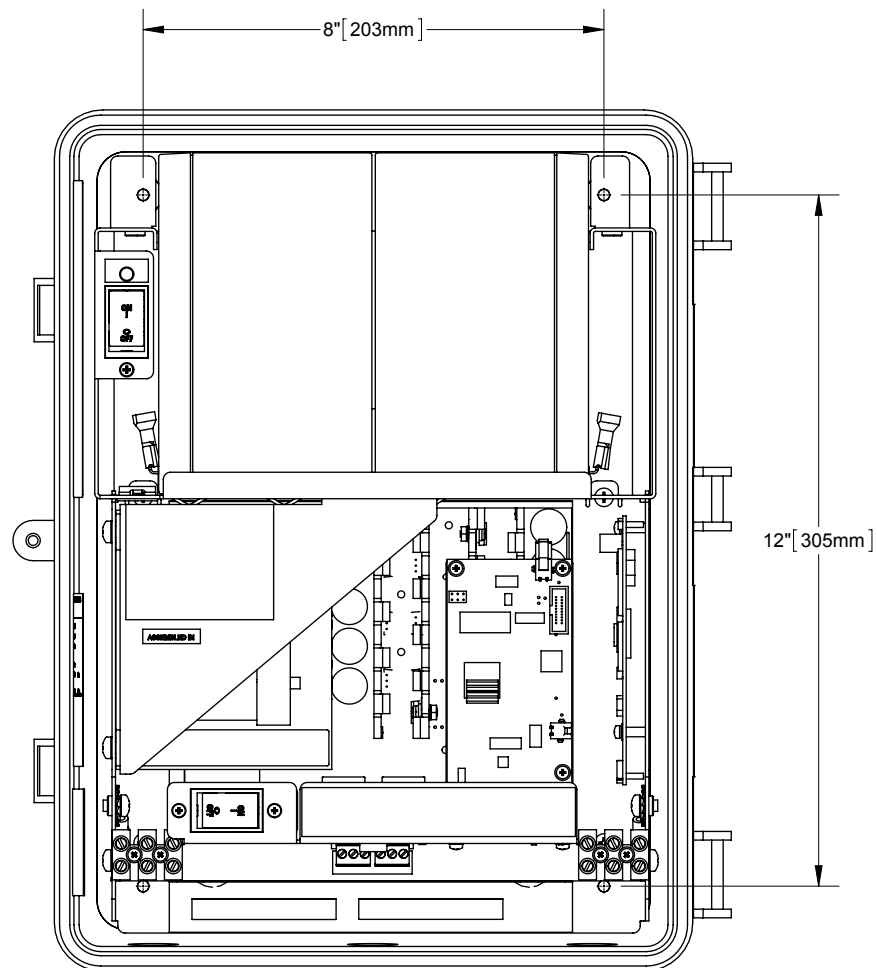

Figure 4 — Wall mounting template

## 7.2.2 Mounting to a Wooden Pole (optional)

The Alpha Micro 100 can be pole mounted with the mounting bracket (Alpha Kit# 740-751-21), which allows you to mount to a wooden pole.

### Procedure:

To bolt the UPS to the pole you need the optional mounting bracket as well as two, ½" bolts (not provided) to fit the pole.

1. Using the mounting bracket as a template, mark the positioning of the two holes on the pole.
2. Drill holes into the pole to fit the bolts.
3. Attach the bracket to the pole.
4. Secure the UPS enclosure to the mounting bracket with the two mounting screws and the two nuts provided with the pole mount kit.

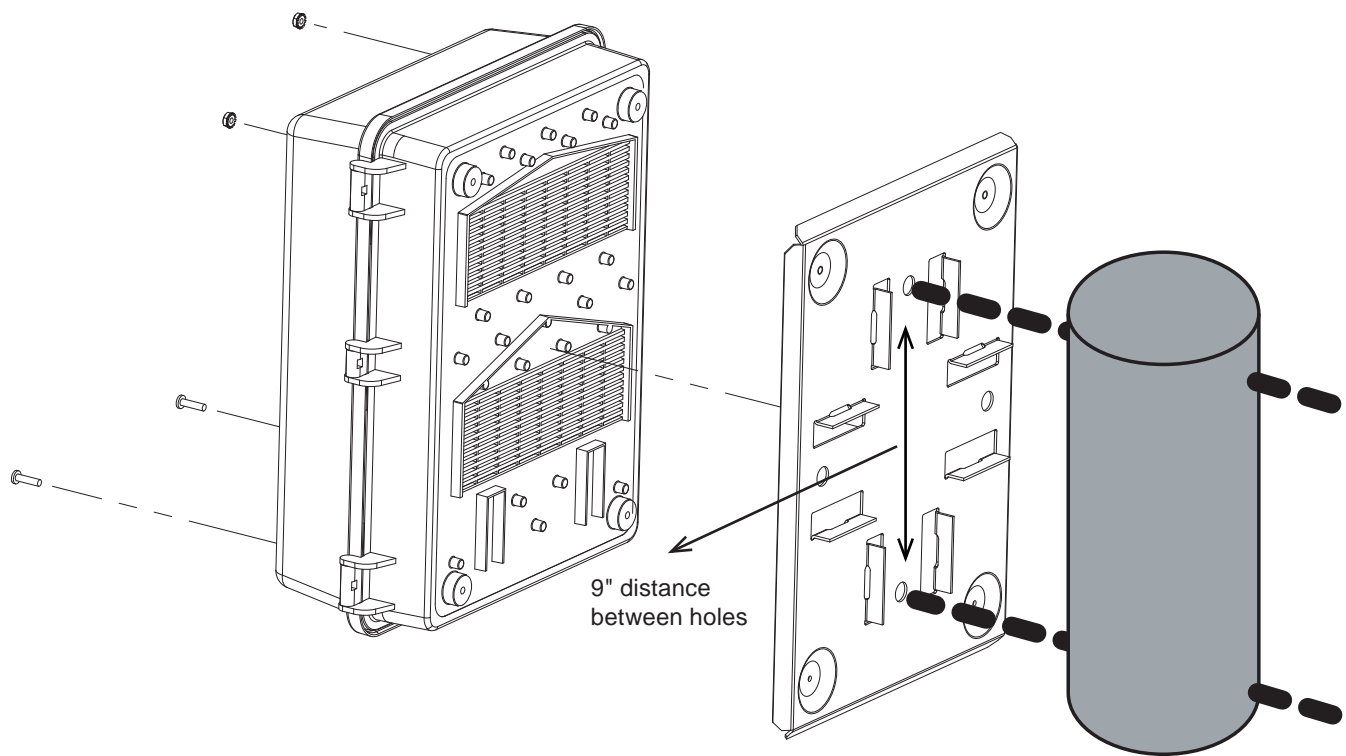

Figure 5 — Mounting to a wooden pole

### 7.2.3 Mounting to a Steel or Concrete Pole

Alpha Kit # 740-751-21

To strap mount the Alpha Micro 100 to the pole you need the optional mounting bracket (Alpha Kit# 740-751-21) and 2, ½" straps (Band-It #C20499 straps, #C00369 Tool and #C25499 Buckle or equivalent).

1. Attach the straps to the mounting bracket.
2. Attach the bracket to the pole. Tighten the strap as per manufacturer's recommendations.
3. Secure the UPS enclosure to the mounting bracket with the two mounting screws and two nuts provided with the pole mount kit.

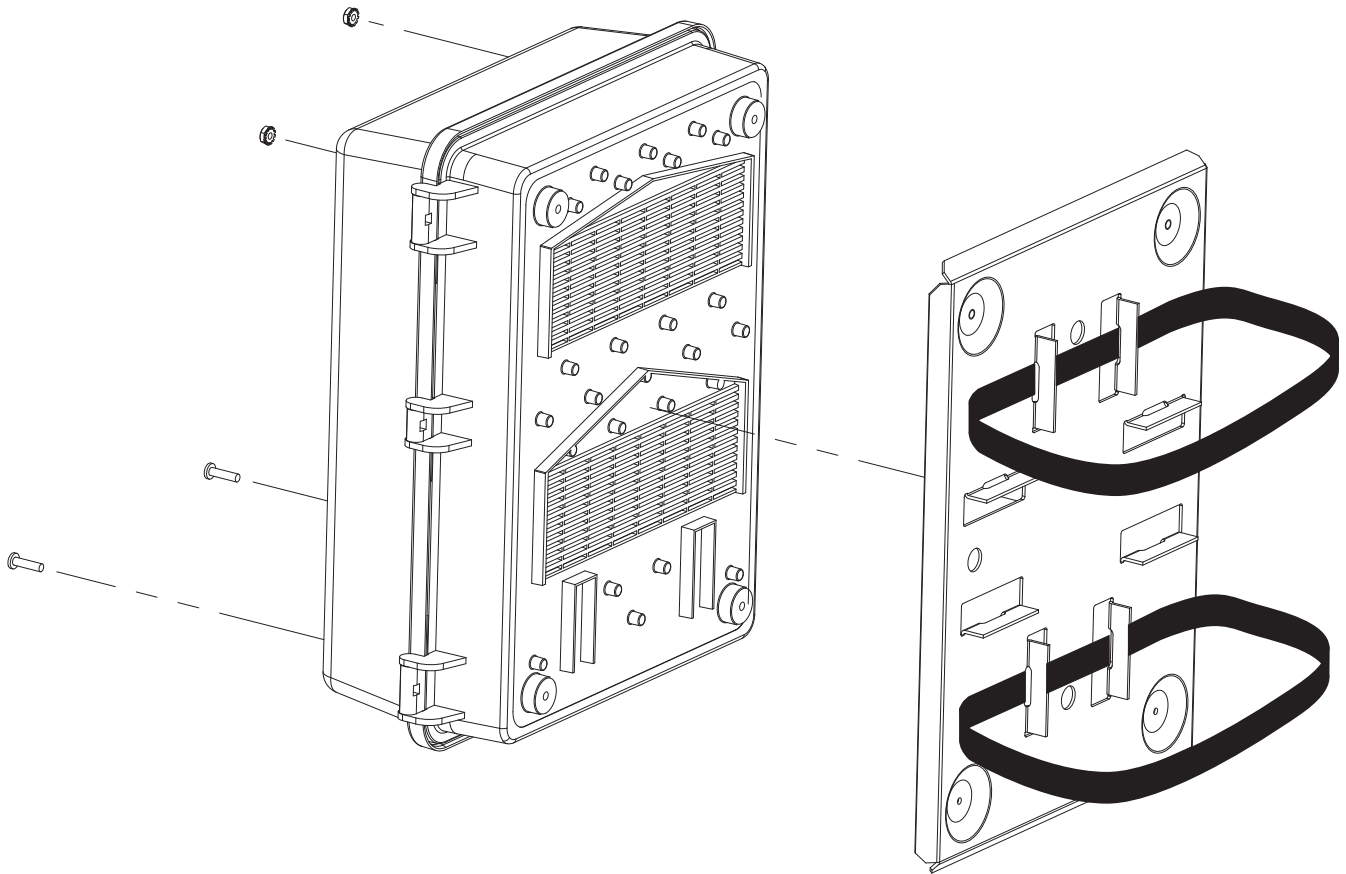

Figure 6 — Mounting to a steel or concrete pole

## 7.3 Wiring the Alpha® Micro 100



### WARNING!

**Before starting, make sure line power is turned off and the UPS Input breaker and the battery breakers are OFF.**

#### 7.3.1 Tools and Materials Required

- Slotted-tip screwdrivers for tightening screws on terminal blocks (1/8in or 5/32in (3.2mm or 4mm) wide)
- DC voltmeter
- Refer to local electrical code for wire sizing and routing. Maximum 12 AWG, 90°C wire for AC input and output connections.
- Liquid tight fitting for AC input/output is for cable with outside diameter range 6.6 - 13.8mm (0.26" - 0.545").
- Liquid tight fitting for network/dry contacts cable can accommodate maximum 3 cables, outside diameter range 4 -6.5mm (0.16" - 0.255").
- If used, maximum of 16 AWG wire for wiring the dry contact terminal blocks. Wire stripped length = ~7 mm (0.275 in)
- 22 AWG max CAT5e cable and crimp tool for RJ 45 connector
- Two open wrenches (size 27mm) for tightening the liquid tight fittings

#### Procedure:

1. Install liquid tight fittings on the three openings.
2. Hand tighten first, then use the open wrenches to tighten an additional 1/4 turn.
3. Route input wire through the liquid tight fitting on the left and wire according to its label (L-N-G). Torque to 7.0 lb-in(0.8 Nm) using the slot screwdriver.
4. If used, connect the dry contact terminal block and/or Ethernet wire through the liquid tight fitting. RJ 45 connector for the Ethernet connection has to be crimped after the wire is routed through the fitting.
5. Route output wire (max gauge 12 AWG) through the liquid tight fitting on the right and wire according to its label (L-N-G). Torque to 7.0 lb-in (0.8 Nm) using the slot screwdriver.

The Alpha Micro 100 has a USB port for configuring the unit on site after installation. If the USB connection is to be permanently installed, the overall length cannot exceed 25 feet. Special crimp tools may be needed to route the cable and connector through the liquid tight fitting.

## 7.4 Installing and Wiring the Batteries

### WARNING!

Before proceeding, verify the line wire is attached to the line terminal block, the ground wire is attached to the ground terminal block and the neutral wire is attached to the neutral terminal block to prevent accidental shock or electrocution. Check this for both the input 2, and the output terminal blocks. Ensure input breaker is off.

Make sure the battery breaker is OFF before wiring the batteries.

Use caution when handling batteries, ensure that the battery terminals do not touch any metal parts.

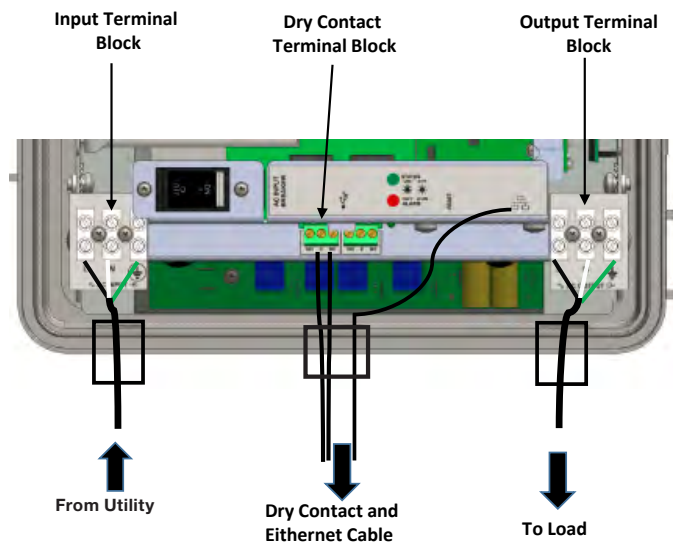

Figure 7 — Wiring the Alpha Micro 100

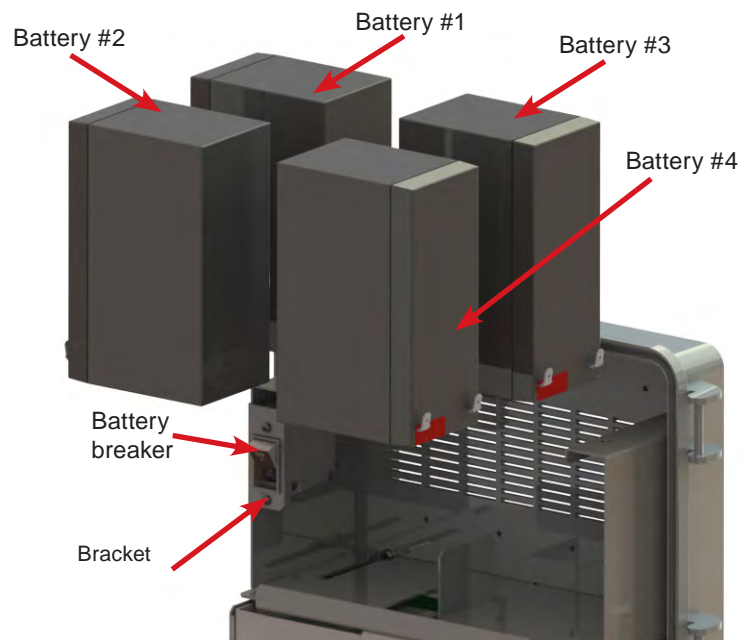
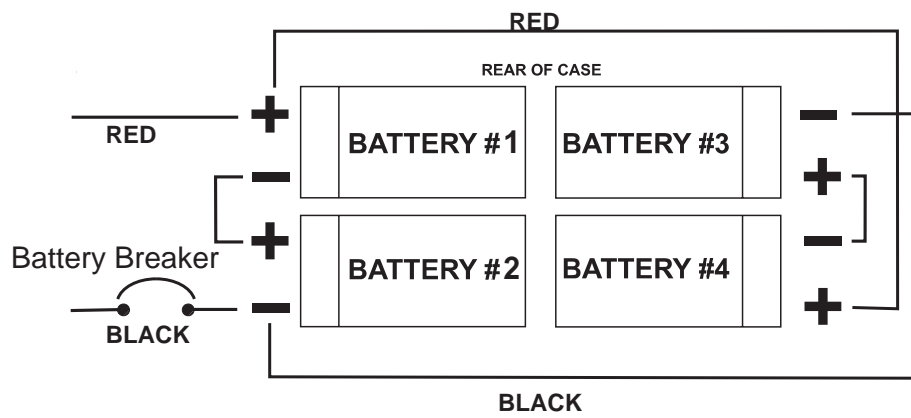

Figure 8 — Battery Locations and Wiring



1. Ensure battery breaker is turned OFF. Install small jumper wire supplied on the negative (-) terminal of battery #1.



2. Connect shorter red cable (with two wires) on the positive (+) terminal of battery #1. Push battery half way in slowly making sure wires are not pinched under the battery breaker bracket.



3. Connect jumper wire from the negative (-) of battery #1 to the positive (+) terminal of the battery #2. Push both batteries all the way into the rear of the battery compartment slowly making sure wires are not pinched.



4. Install 2nd small jumper wire supplied on the positive (+) terminal of battery #3 and connect longer black wire to the battery negative (-). Push battery half way in.

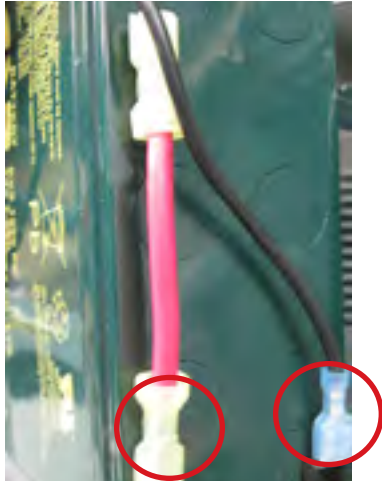

5. Connect jumper wire from the positive (+) terminal of battery #3 to negative (-) terminal of the 4th battery. Route wire in front of the batteries as shown, push both batteries all the way into the battery compartment.



6. Connect longer red cable on the positive (+) terminal of battery #4. Route the wire in the front of the batteries as shown.



7. Connect shorter black cable (with two wires) on the negative (-) terminal of battery #2.



8. With the multimeter in DC range (200V), measure the DC voltage between negative (-) terminal of battery #2 and positive (+) terminal of battery #4 should be between 24-27Vdc with good batteries. Ensure that the voltage polarity is correct.



# 8. Theory of Operation

## 8.1 Block Diagram

The following block diagram shows the interconnection between the four PCB assemblies, input, output and the transformer in the Alpha Micro 100.

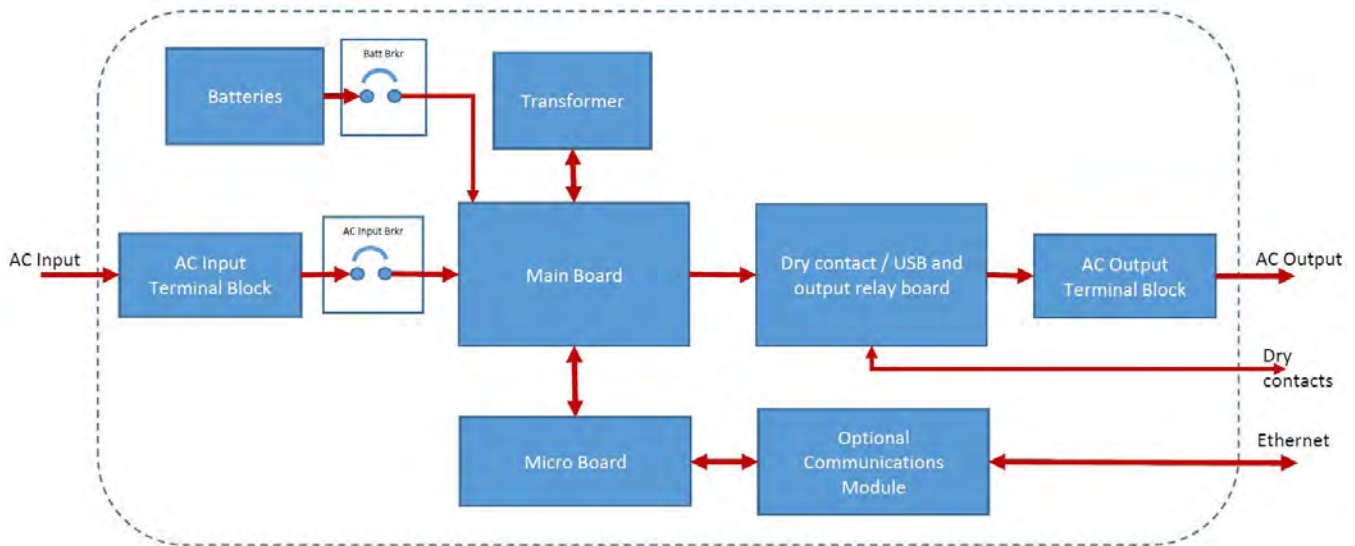

Figure 9 — Micro 100 block diagram

## 8.2 Modes of Operation

The following list of operation modes is explained in the following sections.

- Utility
- Backup (Inverter)
- Standby
- Shutdown
- Fault

### 8.2.1 Utility Mode

In this mode, the unit performs automatic voltage regulation (AVR). For variations in the utility voltage the unit will regulate the output within its 10% nominal value. This is achieved by changing taps on the line frequency transformer and stepping up or stepping down the voltage if needed.

### 8.2.2 Line Mode

If the utility voltage is within 10% of the nominal value, the utility is passed through to the output without any conditioning. This mode is called Line mode. The output is equal to the input.

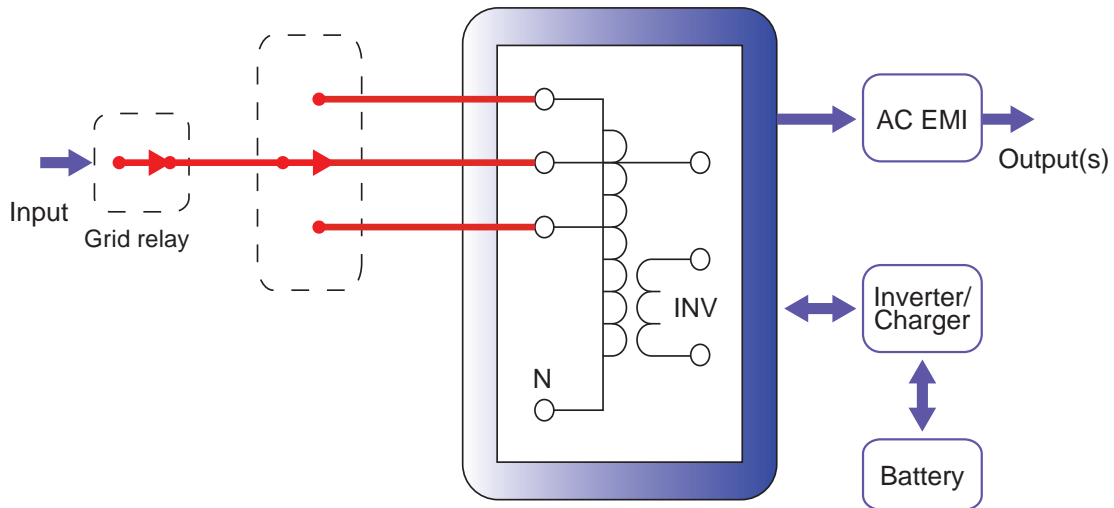

### 8.2.3 Boost Mode

When the input voltage reduces below 10% of the nominal value the microprocessor changes the tap in the transformer and steps the input up to keep the output voltage to within 10% of nominal. To provide a wide operating range, some models have two boost modes.

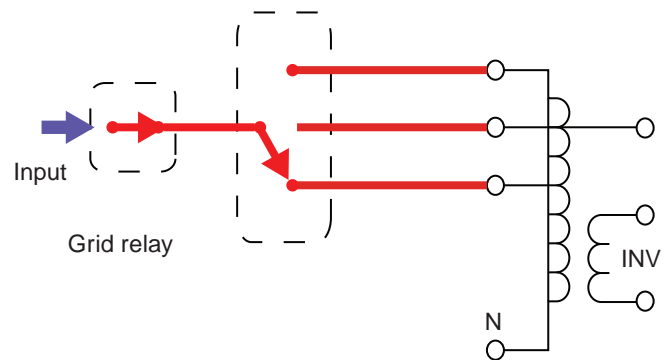

### 8.2.4 Buck Mode

When the input voltage increases above 10% of the nominal value the microprocessor changes the tap in the transformer and steps the input down to keep the output voltage to within 10% of nominal. To provide a wide operating range, some models have two buck modes.

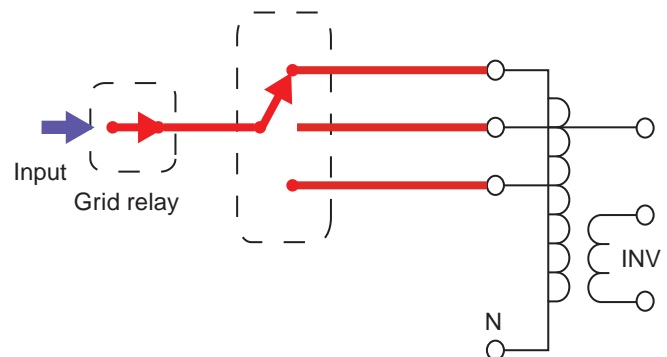

## Battery Charging in Utility Mode (Line)

The battery charging path is shown in the following figure.

The Alpha Micro 100 comes standard with 2 sets of 9AH batteries. The maximum charge current is limited to 3A. The charge current can be set to 0, 1, 2, or 3A.

The Alpha Micro 100 can deliver full power to the AC load and charge the batteries at full capacity, simultaneously.

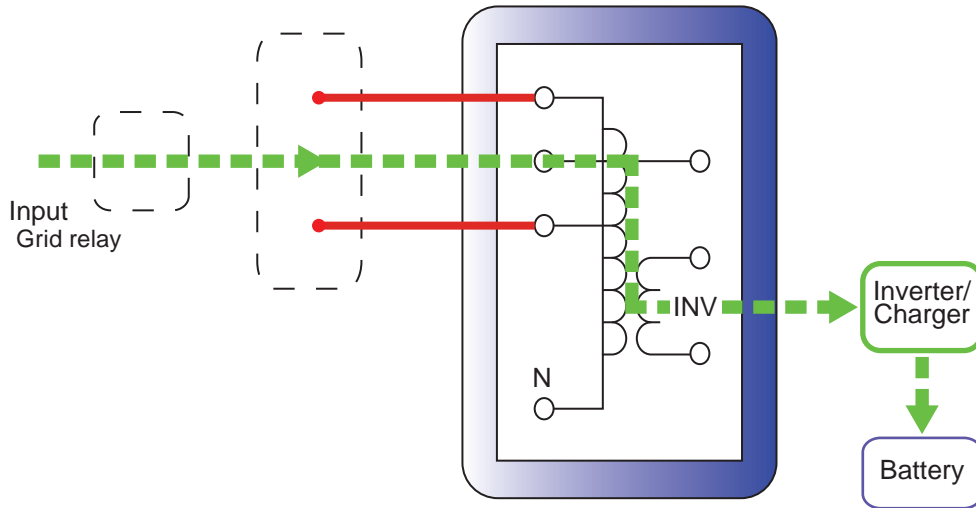

Figure 10 — Battery charging in utility mode

## 8.2.5 Back Up (Inverter) Mode

When the Alpha Micro 100 detects loss of utility, it opens the Grid Relay (preventing AC power back feed) and provides AC power from to the load (in 3 to 5 msec) by inverting DC voltage from the batteries.

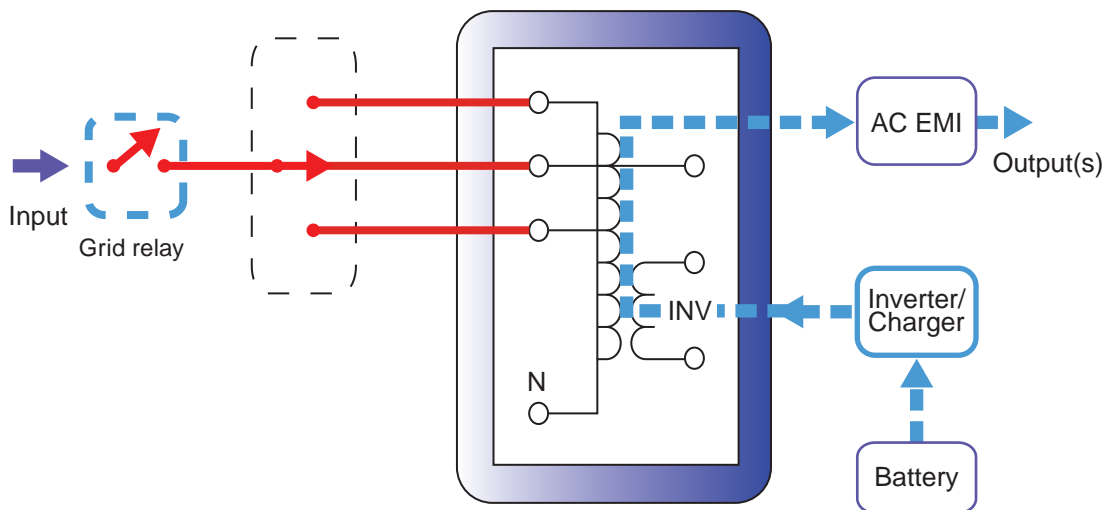

Figure 11 — Back up power from batteries

## 8.2.6 Standby Mode

The Micro 100 will be in standby mode when it is awaiting utility to return. In standby mode, no LEDs will be powered. It will remain in standby mode under the following conditions.

- When battery breaker is closed and AC is not present during initial start up
- Unit was previously running in back up mode after utility failure and has shutdown due to low battery
- A fault condition such as an overload has occurred and shut the unit down. Once the fault is cleared the unit will resume normal operation when utility returns.

## 8.2.7 Shutdown Mode

In Shutdown mode, the Micro 100 will have no AC output. The Alpha Micro 100 can be placed in Shutdown mode in the following ways

- Manually, by turning off the AC and DC breakers, where the internal microprocessor is completely turned Off.
- The Alpha Micro 100 can be placed in Shutdown mode and reset using the web interface or the graphic user interface.

## 8.2.8 Fault Mode

The Alpha Micro 100 enters the fault mode if it encounters a fault (see Table P for list of faults) and will remain in Shutdown mode. Once the fault is cleared, the unit will restart on reset.

## 8.2.9 LED indicators

The Alpha Micro 100 is equipped with 2 LEDs that indicate the status of the UPS. The table shown provides details. Refer to troubleshooting section for further information.

Table G — UPS Operating Modes		
Green	Red	Alpha Micro100 status
OFF	OFF	Unit may not be plugged in or System is off.
OFF	ON	Unit has shutdown due to a Fault. Clear fault and restart unit.
ON	OFF	Line has been qualified and unit is operating in Utility Mode. Normal Operation.
ON	ON-Flashing	Unit is in Line Mode and has an Alarm.
ON	ON	Not applicable.
OFF	ON Flashing	Not applicable.
ON Flashing	OFF	Utility is not qualified and unit is operating in backup mode.
ON Flashing	ON	Not applicable.
ON Flashing	ON Flashing	Unit has an Alarm. Utility is not qualified and unit is operating in backup mode.

Figure 12 — LED status Indicators

# 9. Operating the Alpha<sup>®</sup> Micro 100

---

## 9.1 Switching the Alpha Micro 100 On and Off

Under normal operation, the Micro 100 is always powered ON to supply uninterrupted power to the load. Switching off the Alpha Micro 100 will disconnect the power supply from the load. If for any reason you need to switch off the Alpha Micro 100 while maintaining power to your critical load, make sure that you have a plan that provides an alternate source of power.

### 9.1.1 Switch Off Procedure

1. Switch off the AC input circuit breaker.
2. Switch off the battery circuit breaker.

The status LED turns off. The Alpha Micro 100 is now switched off and no backup power is supplied to the load.

### 9.1.2 Switch On Procedure (Line mode)

Before you put the Alpha Micro 100 back into commission, make sure that the line is qualified and the batteries are fully charged.

1. Switch on the battery circuit breaker. Both LED's will be on for a brief moment and turn off. Unit is in standby mode.
2. Switch on the AC input circuit breaker. The Alpha Micro 100 qualifies the line power. Unit will be in Line, or Buck or Boost mode, depending on the line voltage. The green status LED will be illuminated.
3. If there is no line power, the Alpha Micro 100 remains in Standby mode until the line power is qualified. To provide backup battery power to the load, perform a manual start using the Inverter command via HyperTerminal or web interface. See "Figure 52 — Menu Tree" on page 63.

The Alpha Micro 100 uses auto-frequency detection. When it is first switched on, it senses the line frequency and adjusts its output frequency to match that of the input. The load should be receiving power, If not, refer to Chapter "12. Troubleshooting".

### 9.1.3 Switching from Line Mode Back to Inverter Mode

You can force the Alpha Micro 100 to operate in the Inverter mode by manually switching off the input circuit breaker when in Line mode. Doing so effectively disconnects any line power to the Alpha Micro 100 simulating a power outage which triggers the Alpha Micro 100 to switch to the inverter mode of operation.

#### Procedure:

1. Switch off the input circuit breaker. The green LED starts flashing to show that the Alpha Micro 100 is running on backup battery power. Confirm that the load is receiving power.
2. Turn back the Input breaker On. The unit will return to Line mode indicated by a solid green LED.

### 9.1.4 Switching from Standby mode to Inverter mode

When AC is not present and the loads need AC Power, the Alpha Micro 100 can be forced to output AC using energy from the batteries. To provide backup battery power to the load, perform a manual start by using the Inverter ON command via a USB connection or through the Ethernet connection. Refer section "Figure 51 — Main Menu Screen" on page 62 or the "Figure 26 — UPS Maintenance: Inverter Screen" on page 45.



## 9.2 Operating Modes

The Alpha Micro 100 operating mode automatically changes as a result of changes in the AC input voltage. Refer to Chapter "3. Specifications", for Boost/Buck/Line transfer thresholds.

Mode	Description
<b>SHUTDOWN</b>	The Alpha Micro 100 inverter is switched off. Line power is disconnected from the load.
<b>LINE</b>	The Alpha Micro 100 is switched on. Line power is provided to the load.
<b>BOOST1 or BOOST2</b>	When the input voltage is lower than the nominal voltage, the Alpha Micro 100 raises line voltage without using the batteries. Automatic voltage regulation (AVR) is enabled.
<b>BUCK1 or BUCK2</b>	The Alpha Micro 100 lowers line voltage without using the batteries. AVR is enabled.
<b>INVERTER</b>	The Alpha Micro 100 is providing backup battery power to the load.
<b>RETRAN</b>	The Alpha Micro 100 is transferring from Inverter mode to Line mode.
<b>TRAN</b>	The Alpha Micro 100 is transferring from the state it is now in into Inverter mode.
<b>STANDBY</b>	The Alpha Micro 100 is switched on and waiting for the line power to be qualified or the user to clear some faults. CAUTION: Do not touch the AC output terminals; they may become energized.
<b>BYPASS</b>	This locks the unit into line mode and turns off the battery charger so the unit can work with a manual break-before-make bypass switch. AVR will be disabled. This mode may be used to service the batteries.

## 9.3 Control Parameters

The Alpha Micro 100's parameters can be controlled, programmed and adjusted to suit a user's specific application needs. The following table lists the various parameters and their functions. These parameters can be accessed and modified using the web interface or the USB serial port.

Web Interface	Description
<b>AC Output Shutdown</b>	When this function is switched on, the Alpha Micro 100 inverter is shut off. Neither Line nor Inverter power is supplied to the load.
<b>DC Output Shutdown</b>	When this function is switched On, the LVD configured relay will be de-energized. Applies when ANY programmable dry contact is programmed to be the LVD indicator. When the function is switched from On to Off, a 10 second delay occurs before the LVD configured relay is re-energized.. See "9.7.4 Programming the Dry Contacts" on page 67.
<b>Bypass Mode</b>	This function can be enabled only when the Alpha Micro 100 is in Line mode. When enabled, the unit can work with a manual break-before-make bypass switch. AVR and battery charger will be disabled. This mode may be used to service the batteries.
<b>Power Quality or AVR</b>	This function toggles between: AUTOMATIC VOLTAGE REGULATION (AVR): The buck and boost modes are active. OR: QUALITY: The buck and boost modes are switched off, the input voltage is the Alpha Micro 100 output voltage.
<b>Sense Normal or Generator</b>	This function can only be used when the Alpha Micro 100 is in Standby or Shutdown mode—see Table H for operating mode descriptions.  This function toggles between: <b>NORMAL:</b> The Alpha Micro 100 can operate successfully with most line conditions. or, <b>GENERATOR:</b> The Alpha Micro 100 input voltage and frequency parameters are expanded so the Alpha Micro 100 can work with the fluctuations caused by a generator or noisy line.
<b>Rated Input Frequency</b>	The frequency can only be changed when the Alpha Micro 100 is in Standby mode. This lets you set the Alpha Micro 100's frequency setting to 50 Hz or 60 Hz. This should ONLY be done by a qualified technician acting under the instructions of Alpha Technologies Customer Service Department. See "Service and Technical Support". Failure to contact Alpha Technologies before doing this procedure could void your warranty.

**Table I – Control Parameters**

Web Interface	Description
<b>Rated Input Voltage</b>	Lets you set the Alpha Micro 100 input voltage setting to 120 Vac or 230 Vac. This should <b>ONLY</b> be done by a qualified technician acting under the instructions of Alpha Technologies Customer Service Department. Failure to contact Alpha Technologies before performing this procedure could void your warranty.
<b>Line qualify time</b>	Lets you set how long it takes for the Alpha Micro 100 to return to Line mode after the line has become requalified to make sure the line is stable. It can be set to 3, 10, 20, 30, 40 or 50 seconds. The factory default setting is 3 seconds.
<b>Battery Test</b>	Starts the battery test that uses depth-of-discharge setting that can be adjusted using Battery Test Depth of Discharge menu.
<b>Battery Test Depth of Discharge</b>	Lets you set the desired battery test depth-of-discharge to a value between 0 and 100%. Make sure that the set time duration is shorter than the max back up time of your battery bank. Otherwise, you will drain the battery and trigger a fault – <b>Batt Volt Low</b> . The default value is set to 20% DoD.
<b>Enable Auto Battery Test</b>	Enable/Disable the scheduled battery self test.
<b>Battery temperature compensation</b>	Lets you set the battery temperature compensation to match the batteries you are using. It can be set to -2.5, -4, -5 or -6 mV/°C/Cell. The factory default setting is -5 mV/°C/Cell.
<b>Max charge current</b>	Allows you to set the battery charger current. NOTE: Setting the battery charger to 0 A will turn the charger off. The default value is set to 3A.
<b>DC Output Connect Voltage</b>	One of the dry contacts of the Alpha Micro 100 can be programmed to operate as a control for external DC disconnect and reconnect. (See LVD setting under 9.7.4 on page 67). The dry contact is energized when the battery voltage is greater than the DC Connect set voltage and will de-energize if the battery voltage drops below 21V for 24V system.
<b>Inverter</b>	When inverter mode is set to ON, the Alpha Micro 100 provides backup battery power to the load. This mode of operation is normally activated automatically when line power becomes unavailable, or the line power is not qualified. You can also put the Alpha Micro 100 into this mode during initial startup in the absence of line power or because of unqualified line power.
<b>Clear Inverter Counter and Timer</b>	This clears the inverter counter and timer from the inverter section under UPS maintenance. This does not clear the 200-event log.
<b>24-hour Clock</b>	Lets you select which format to display time information: in 24 hour clock format or 12 hour clock (AM/PM) format.
<b>Enable daylight savings time</b>	Switch ON this option to activate daylight savings time.
<b>Date Format Selection</b>	This lets you toggle the Alpha Micro 100 date format between YY-MM-DD, MM-DD-YY, YYYY-MM-DD, MM-DD-YYYY, DD-MM-YYYY, YY-TXT-DD, TXT-DD-YY, DD-TXT-YY, YYYY-TXT-DD, TXT-DD-YYYY, DD-TXT-YYYY, YYYY-DD-TXT, YY-DD-TXT, YYYY-DD-MM, YY-DD-MM. The factory default setting is MM-DD-YY.

## 9.4 Battery Charging Options

The batteries for the Alpha Micro 100 are located internal to the unit. The default charging algorithm has been designed for optimum performance of the UPS and the batteries. Unless absolutely required it is recommended not to modify or adjust the charging method or other battery parameters.

This procedure may be performed using the Web Interface.



### CAUTION!

**Any changes and adjustments to the charge algorithm must be made only by qualified personnel, who understand the different charging modes and their suitability to the battery chemistry.**

### 9.4.1 Standard Charging Method

#### Standard Charger Mode

In this mode the UPS charges the battery with a constant target voltage and limiting the maximum charge current. However when the battery reaches the target voltage and the charge current drops to a small value, the charger can be set to two options:

**Auto:** When BATT FLOAT is set to AUTO, the float voltage is set to 0.9V below the max charge voltage. The default max charge voltage is 27.3V and default float is 26.4V, both at 25°C.

**Constant (default from factory):** When BATT FLOAT is set to Constant, the default max charge voltage is 27.3V and float is 27.1V, both at 25°C. Temperature compensation will be active.

### 9.4.2 Bulk Charging

The bulk charging method allows a voltage range for the maximum charge voltage to be set by the user. It also allows a voltage range for the float voltage to be set by the user, up to the maximum of the bulk voltage setting. Temperature compensation will be set to 0 mV/°C / cell as default. The user can choose to modify this with the available settings.

In both methods of charging the user can set the maximum charge current.

The following table includes the three parameters which are only available when the bulk battery charging method is selected:

Table J — UPS Operating Modes - 24V			
Parameter	Default	Minimum	Maximum
Max Charger Voltage (Vdc)	26.8	26	28
Float Charger Voltage (Vdc)	26.8	26	28
Low Voltage Warning* (Vdc)	22	22	23

\*Low voltage warning value has to be higher than **Low Voltage Disconnect** and lower than **Low Voltage Reconnect**.

Figure 13 — Bulk Charging Parameters

The following screen images provide a view of the navigation through the various screens of the Web Interface. The default password is 1111.



Alpha Technologies  
FPM Communication Module

UPS MODE: Bypass

Alarms: Faults

UPS Specification

- UPS Monitoring
  - Input & Output
  - Battery & Inverter
  - Relay & Load Shed
  - User Input
  - Power Outage
- UPS Maintenance
  - Unit Configuration
  - Battery
  - Inverter
  - Relay & Load Shed
  - Time & Date
  - Password
  - User Input
  - Power Outage
- Event Manager
- Upgrade Files
- Configure Site Information
- Communications
- Keep Alive

**Battery Primary Configuration**

	Current	New
Rated Battery Voltage	24 VDC	24
Battery Charging Method	Standard	Standard

Update Configuration

**Battery Test**

	Current	New	
Test	Off	On	Off
Test Depth-of-discharge	60 %	60	

Update Configuration

**Auto Battery Test Settings**

	Current	New	
Enable Auto Battery Test	Off	On	Off
Day	Monday	Monday	
Time (hh-mm-ss)	12:00:00 AM	12	00
		PM	AM
Test Interval In Week	4	4	

Update Configuration

**Battery Configuration**

	Current	New
Standard Charger Mode	Constant	Constant
Temperature Compensation	-5.0 mV/Cell/°C	-5.0
Max Charger Current	6 A	6
Low Battery Warning	40 %	40
Peukert Number	1.1000	1.1000
Capacity	7.20 Ah	7.20
Battery Open-Circuit Voltage	25.75 VDC	25.75
Low Voltage Disconnect	21 VDC	21
Low Voltage Reconnect	24 VDC	24

Update Configuration

Alpha Technologies  
FPM Communication Module

UPS MODE: Bypass

Alarms: Faults

UPS Specification

- UPS Monitoring
  - Input & Output
  - Battery & Inverter
  - Relay & Load Shed
  - User Input
  - Power Outage
- UPS Maintenance
  - Unit Configuration
  - Battery
  - Inverter
  - Relay & Load Shed
  - Time & Date
  - Password
  - User Input
  - Power Outage
- Event Manager
- Upgrade Files
- Configure Site Information
- Communications
- Keep Alive

**Battery Primary Configuration**

	Current	New
Rated Battery Voltage	24 VDC	24
Battery Charging Method	Standard	Standard

Update Configuration

**Battery Test**

	Current	New	
Test	Off	On	Off
Test Depth-of-discharge	60 %	60	

Update Configuration

**Auto Battery Test Settings**

	Current	New	
Enable Auto Battery Test	Off	On	Off
Day	Monday	Monday	
Time (hh-mm-ss)	12:00:00 AM	12	00
		PM	AM
Test Interval In Week	4	4	

Update Configuration

**Battery Configuration**

	Current	New
Standard Charger Mode	Auto	Auto
Temperature Compensation	-5.0 mV/Cell/°C	-5.0
Max Charger Current	6 A	6
Low Battery Warning	40 %	40
Peukert Number	1.1000	1.1000
Capacity	7.20 Ah	7.20
Battery Open-Circuit Voltage	25.75 VDC	25.75
Low Voltage Disconnect	21 VDC	21
Low Voltage Reconnect	24 VDC	24

Settings have been saved

Update Configuration

Figure 14 — Web Interface: Bulk Charging Menus



Alpha Technologies  
Power  
FXM Communication Module

UPS MODE: Bypass

Alarms: Faults

- UPS Specification
  - UPS Monitoring
    - Input & Output
    - Battery & Inverter
    - Relay & Load Shed
    - User Input
    - Power Outage
  - UPS Maintenance
    - Unit Configuration
      - Battery
      - Inverter
      - Relay & Load Shed
      - Time & Date
      - Password
      - User Input
      - Power Outage
    - Event Manager
    - Upgrade Files
  - Configure Site Information
  - Communications
  - Keep Alive

**Battery Primary Configuration**

	Current	New
Rated Battery Voltage	24 VDC	24
Battery Charging Method	Standard	Bulk

[Update Configuration]

**Battery Test**

	Current	New
Test	Off	On
Test Depth-of-discharge	60 %	60

[Update Configuration]

**Auto Battery Test Settings**

	Current	New
Enable Auto Battery Test	Off	On
Day	Monday	Monday
Time (hh-mm-ss)	12:00:00 AM	12:00:00 AM
Test Interval In Week	4	4

[Update Configuration]

**Battery Configuration**

	Current	New
Standard Charger Mode	Auto	Auto
Temperature Compensation	-5.0 mV/Cell/°C	-5.0
Max Charger Current	6 A	6
Low Battery Warning	40 %	40
Peukert Number	1.1000	1.1000
Capacity	7.20 Ah	7.20
Battery Open-Circuit Voltage	25.75 VDC	25.75
Low Voltage Disconnect	21 VDC	21
Low Voltage Reconnect	24 VDC	24

Settings have been saved

[Update Configuration]

**Select Charger**

Charger settings are for advanced users and may cause damage to batteries if improperly set. Select Proceed to acknowledge the risk and continue. The batteries should be disconnected to avoid potential damage.

[Proceed] [Revert]

Alpha Technologies  
Power  
FXM Communication Module

UPS MODE: Bypass

Alarms: Faults

- UPS Specification
  - UPS Monitoring
    - Input & Output
    - Battery & Inverter
    - Relay & Load Shed
    - User Input
    - Power Outage
  - UPS Maintenance
    - Unit Configuration
      - Battery
      - Inverter
      - Relay & Load Shed
      - Time & Date
      - Password
      - User Input
      - Power Outage
    - Event Manager
    - Upgrade Files
  - Configure Site Information
  - Communications
  - Keep Alive

**Battery Primary Configuration**

	Current	New
Rated Battery Voltage	24 VDC	24
Battery Charging Method	Bulk	Bulk

[Update Configuration]

**Battery Configuration**

	Current	New
Temperature Compensation	0.0 mV/Cell/°C	0.0
Max Charger Current	6 A	6
Max Charger Voltage	26.7 VDC	26.7
Float Charger Voltage	26.7 VDC	26.7
Low Voltage Warning	22 VDC	22
Low Voltage Disconnect	21 VDC	21
Low Voltage Reconnect	24 VDC	24

[Update Configuration]

Figure 15 — Web Interface: Bulk Charging Menus

## 9.5 Operating via the Communication Module (Intranet or Internet)

The internet or a company intranet can be used to communicate with the Alpha Micro 100 through the factory-installed communication module. In addition, it can be monitored and controlled via a web browser or with SNMP protocols.

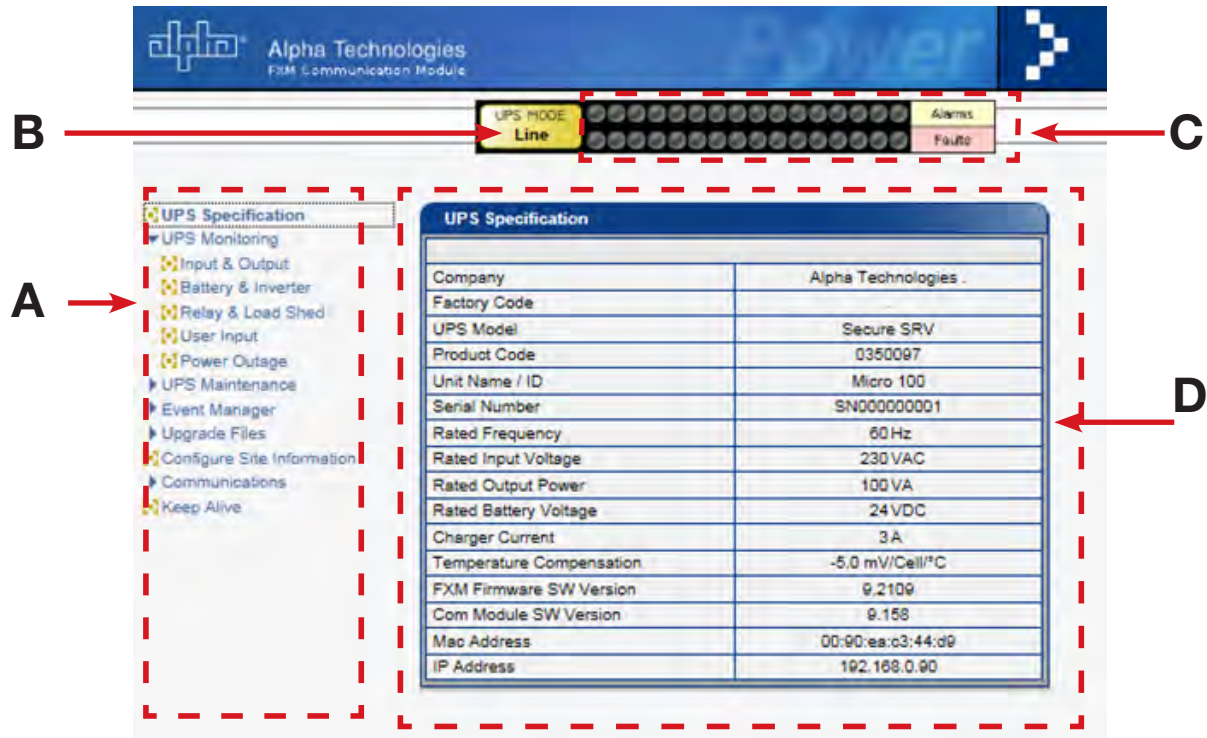

<b>A</b>	Screen selection menus
<b>B</b>	Current UPS operating mode. Updates automatically.
<b>C</b>	Fault and alarm indicators – when a light in this bar is illuminated, move the mouse cursor over the light to determine the detail of the fault alarm. Double-clicking the light takes you to the Alarms and Faults screen.
<b>D</b>	Current values.

Figure 16 — Web Interface: UPS Specification Screen shown

## 9.5.1 Installation and Set Up

The following tools and materials are needed:

- Computer with network card and web browser
- Ethernet cable (only required if SNMP card is installed)
- The UPS Final IP Address and Subnet Mask and if needed the Default Gateway and the DNS Server addresses



### CAUTION!

**To successfully complete this procedure, you should have a working knowledge of network protocols and how to configure them. Consult your network administrator for details.**

**If multiple UPS are installed on the same network, configure each unit's IP address before the installation. Each UPS on the network MUST have its own unique IP address.**

#### Procedure:

1. Connect the Alpha Micro 100 to a personal computer with either the Ethernet cable or hub.
2. Configure the computer network card to talk to the Alpha Micro 100 communication module. The module's default address is `http://192.168.0.90`.
3. Open the web browser on the computer.
4. In the browser window, type in the default IP address and press Enter.
5. From the home screen, select **Communications > Configure TCP/IP** (password required).
6. Configure the TCP/IP properties according to your network's requirements and note the IP address of the unit.
7. Click Apply Settings.



#### NOTE:

**To rest the IP address, press and hold down the IP Reset button (see Figure 2) for ten seconds. IP address will rest to factory default of 192.168.0.90**

Internet Protocol (TCP/IP) Properties	
Current IP Address	
<input type="checkbox"/> Obtain an IP address automatically	
IP Address	
Subnet mask	
Default gateway	
<input type="checkbox"/> Obtain DNS server address automatically	
Preferred DNS server	
Alternate DNS server	
<input type="button" value="Apply Settings"/>	

Figure 17 — Communications Screen

## 9.5.2 UPS Specifications

This screen displays factory default specification of Alpha Micro 100.

The screenshot shows the 'UPS Specification' screen. At the top, there is a blue header with the Alpha Technologies logo and the text 'Alpha Technologies FXM Communication Module'. Below the header is a status bar with 'UPS MODE Line' and 'Alarms Faults'. The main content area is divided into a left navigation menu and a right table.

**UPS Specification**

Company	Alpha Technologies .
Factory Code	
UPS Model	Secure SRV
Product Code	0350097
Unit Name / ID	Micro 100
Serial Number	SN000000001
Rated Frequency	60 Hz
Rated Input Voltage	230 VAC
Rated Output Power	100 VA
Rated Battery Voltage	24 VDC
Charger Current	3 A
Temperature Compensation	-5.0 mV/Cell/°C
FXM Firmware SW Version	9.2109
Com Module SW Version	9.158
Mac Address	00:90:ea:c3:44:d9
IP Address	192.168.0.90

Figure 18 — UPS Specification Screen



### 9.5.3 UPS Monitoring

These read-only screens show the Micro 100 current input and output values and other measurements.

#### UPS Monitoring > Input and Output

Shows the Alpha Micro 100 current input and output values and the present operating mode.

**NOTE:**  
**Voltage 2 and Current 2 are the output voltage and current of the 24Vac output. Based on individual unit configuration 24Vac output not available on Micro 100.**

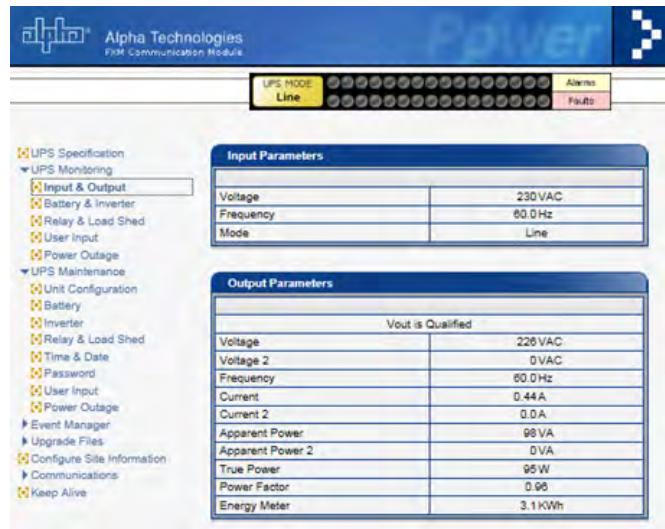

Figure 19 — UPS Monitoring: Input and Output Screen

#### UPS Monitoring > Battery and Inverter

Shows the battery string status and how many times and for how long the inverter has been active.

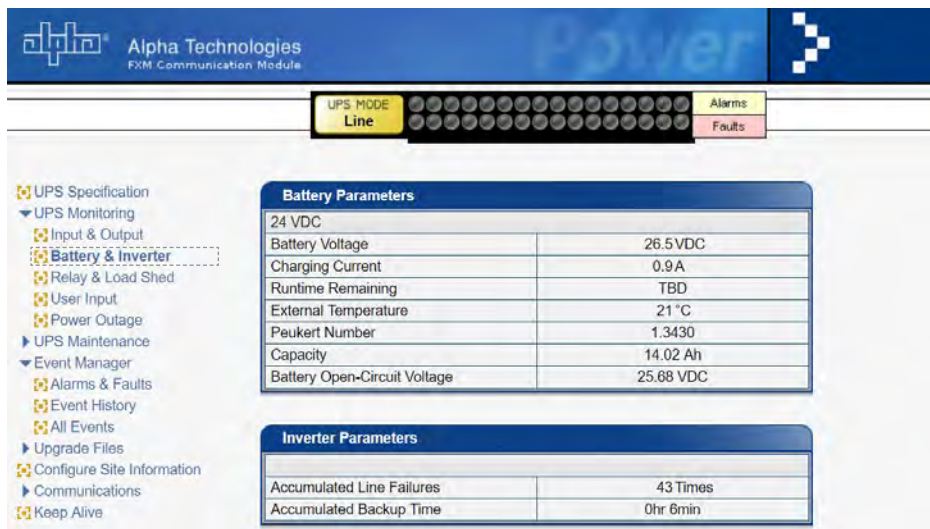
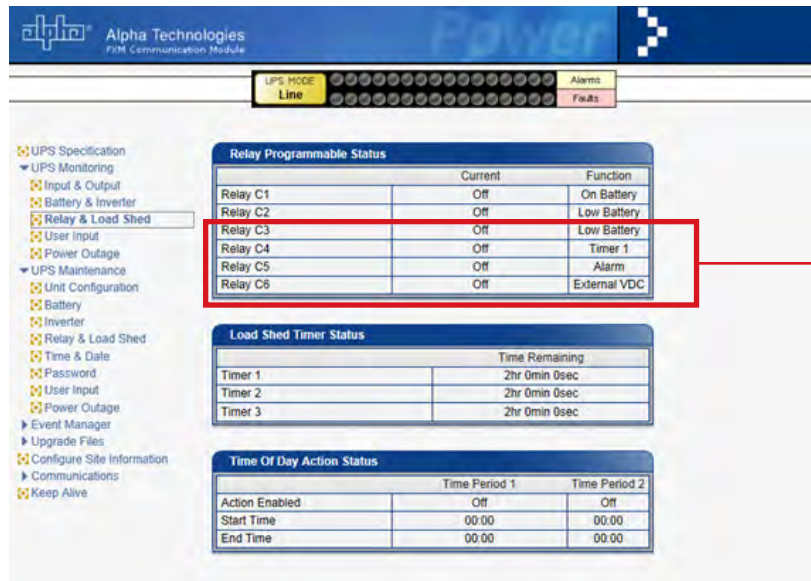

Figure 20 — UPS Monitoring: Battery and Inverter Screen—Standard Charging

## Monitoring > Relay and Load Shed

Shows how the front panel dry contacts are configured. If any relays are used for load shedding, the time setting is shown. The Alpha Micro 100 has only two dry contacts available.



C2 to C6 not available on the Micro 100.

Figure 21 — Web GUI: Relay and Load Shed screen

## Monitoring > User Input Status

User inputs are not available on Alpha Micro 100.

## Monitoring > Power Outage

Shows the last five power outages (Input Voltage = 0Vac) experienced by the Alpha Micro 100. It does not take into account duration unit ran on batteries if input voltage is not within the acceptable range. In the section USB Maintenance - power outage users can set up time in minutes for which unit will ignore any small power outages. This will avoid triggering nuisance alarms for any short duration power irregularities.

The unit also records time the duration of time that the unit ran on batteries to provide output power to the load, start time of power outage, end time of power outage, and the duration of the outage.

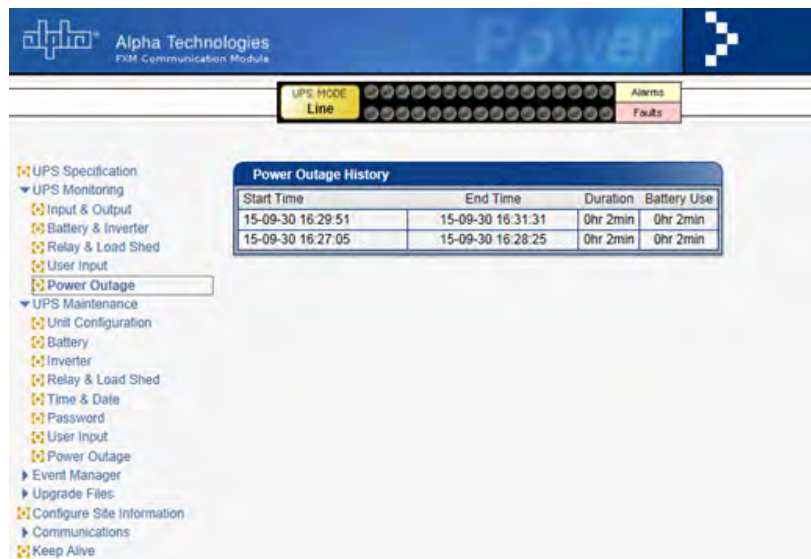

Figure 22 — UPS Monitoring: Power Outages

## 9.5.4 UPS Maintenance Menus

Use the UPS Maintenance screens to configure and adjust the Alpha Micro 100 to meet your operating needs.

To change parameters, either click the **On/Off** buttons or select an item from a drop down menu.

To execute the changes, click on the **Update Configuration** button.

### UPS Maintenance > Unit Configuration

Sets the name, input, output parameters and how often the webpage refreshes.

	Current	New
Unit Name / ID	Micro 100	Micro 100
AC Output Shutdown	Off	On Off
DC Output Shutdown (On=>Off: 10s delay)	Off	On Off
Bypass Mode	Off	On Off
Temperature in Fahrenheit	Off	On Off
Power Quality or AVR	AVR	Quality AVR
Sense - Normal or Generator	Normal	Gen Normal
Automatic Frequency Detection	Enabled	Enabled Disabled
Rated Frequency	60 Hz	60
Rated Input Voltage	230 VAC	230
Line Quality Time	3 Sec	3
Status Refresh Time	1 Sec	1

**Note:** A 120Vac unit cannot be configured as a 230Vac unit or vice versa.

Figure 23 — UPS Maintenance: Unit Configuration screen

## 9.5.5 Restoring All Parameters to Default Values

The purpose of this command is to reset the Alpha Micro 100 to the factory default parameters in Table K.



### CAUTION!

**This command resets all parameters that are user-configurable. This command is password protected. All previously programmed operation will be lost.**

	Current	New
Unit Name / ID	Micro 100	Micro 100
AC Output Shutdown	Off	On Off
DC Output Shutdown (On=>Off: 10s delay)	Off	On Off
Bypass Mode	Off	On Off
Temperature in Fahrenheit	Off	On Off
Power Quality or AVR	AVR	Quality AVR
Sense - Normal or Generator	Normal	Gen Normal
Automatic Frequency Detection	Enabled	Enabled Disabled
Rated Frequency	60 Hz	60
Rated Input Voltage	230 VAC	230
Line Quality Time	3 Sec	3
Status Refresh Time	1 Sec	1

Figure 24 — Restore all default commands

**Table K – List of Parameters**

Parameters	Default Settings
Battery charging current (Amps)	3
Temperature compensation of battery charging (mV/°C/Cell)	Standard charging method: -5.0 Bulk charging method: 0
Maximum charge voltage: Standard > Auto mode @25°C (V)	27.3
Maximum float voltage: Standard > Auto mode @25°C (V)	26.4
Maximum charge voltage: Standard > Constant mode @25°C (V)	27.3
Maximum float voltage: Standard > Constant mode @25°C (V)	27.1
Maximum charge voltage: Bulk mode (V)	26.7
Maximum float voltage: Bulk mode (V)	26.7
Default low battery warning Bulk mode (V)	22
Start hour of rush hour of time of day action period #1	0
Start minute of rush hour of time of day action period #1	0
End hour of rush hour of time of day action period #1	0
End minute of rush hour of time of day action period #1	0
Start hour of rush hour of time of day action period #2	0
Start minute of rush hour of time of day action period #2	0
End hour of rush hour of time of day action period #2	0
End minute of rush hour of time of day action period #2	0
Line qualify time (sec)	3
Time setting of periodical self-test (minute) (hh:mm)	00:00
Inverter off delay setting (sec)	0
Inverter cutoff	disabled
Enable auto battery test	disabled
Number of weeks setting of periodical self-test	4
Day of the week setting of periodical self-test	Monday
Time of the day setting of periodical self-test	0
Battery low warning threshold setting (%)	40
Low voltage disconnect	21
Low voltage reconnect	24
Self test depth-of-discharge setting (%)	20
Time Of Day Action Enabled	Disabled
Load shed timer1 duration	2 hours
Load shed timer2 duration	2 hours
Load shed timer3 duration	2 hours
Programmable dry contact #1 setting	On Battery
Programmable dry contact #2 setting	Low Battery
Password setting	1111



**UPS Maintenance > Battery:** Allows adjustments of battery string voltage, charging parameters, low battery warning setting, periodic self test time and starts the self test.

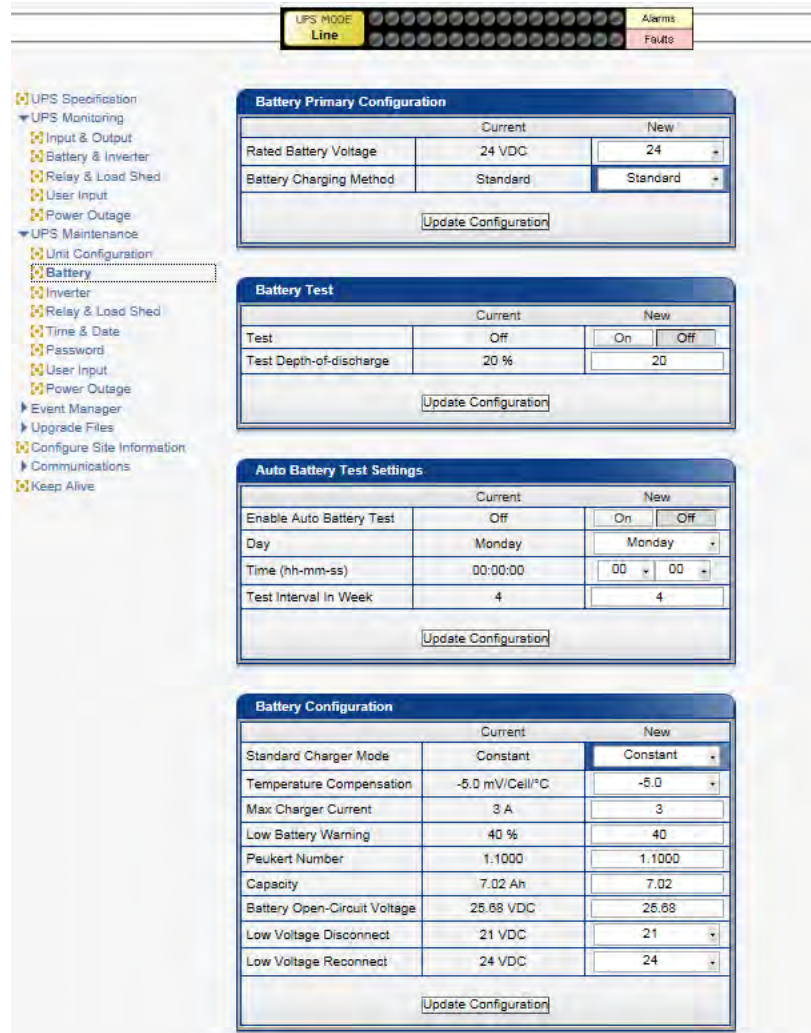

Figure 25 — UPS Maintenance: Battery Screen

An accurate battery runtime estimation requires adjustment of the following parameter:

- **Peukert Number:** Refer to "Peukert Number" on page 73 for calculation of the Peukert number to enter here.
- **Battery Capacity:** Rated capacity (Ah) of the battery shown on the battery data sheet at 20 hour rate. The battery data sheet shows the value for a single battery, so for a 24V system where two batteries are connected in series, this number must be multiplied by two.
- **Battery Open Circuit Voltage:** This number is obtained from the battery data sheet. The battery data sheet shows the value for a single battery, so for a 24V system where two batteries are connected in series, this number must be multiplied by two.

The Battery Runtime Remaining algorithm attempts to calculate the health of the battery to get a more accurate prediction of the remaining battery runtime. An accurate estimate of the battery health requires that at least one battery discharge cycle greater than 20% depth of discharge has taken place since the unit was switched on. When the unit is powered up from an off state, the algorithm assumes that a new battery is connected to the unit. Each discharge of greater than 20% will result in a new calculation for the relative battery health. This value is then used in the Battery Runtime Prediction algorithm to compensate for an aging battery. We recommend that the user set up a periodic (every 6 months) battery test with a depth of discharge of at least 20%.

The Battery Runtime Remaining algorithm relies heavily on the battery voltage to predict the remaining runtime. This results in a less accurate predicted runtime during periods when the battery voltage is changing rapidly. The battery voltage typically changes rapidly during the first few minutes of discharge when the unit switches from charging to discharging while the unit is in the Inverter mode. The battery voltage may also change rapidly during the last 20% of the discharge time when the battery is almost drained.



**CAUTION!**

**The Battery Runtime is only an estimation and must not be relied on for critical applications. The Battery Runtime remaining is applicable only in Inverter/Backup mode.**



**NOTE:**

**Battery runtime calculation are not performed if Bulk charging mode is selected.**

**UPS Maintenance > Inverter:** Turns the inverter on or off to start or stop backup battery power to the load.

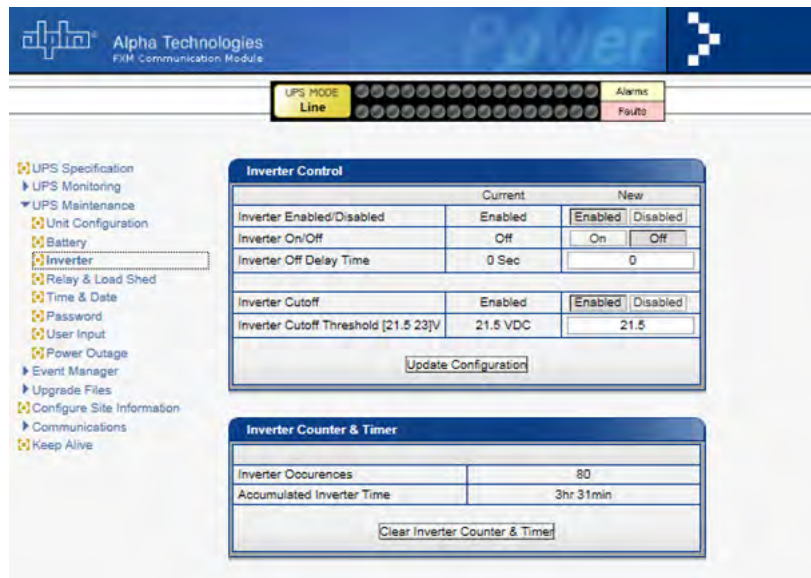

Figure 26 — UPS Maintenance: Inverter Screen

**Inverter Enabled/Disabled**

Enabled: the inverter can function depending on the setting of the Inverter On/Off field.  
 Disabled: the Alpha Micro 100 will not go into Inverter mode when it loses AC power.

**Inverter On/Off**

Selecting inverter On/Off will not turn on the inverter unless inverter is enabled first.

**Inverter Off Delay Time**

Used to set a delay before the inverter switches off to allow time for switching off critical loads. The set Inverter ON/OFF delay is only available when the Alpha Micro 100 is in the Battery or Standby modes.

The delay can be adjusted in 1 second steps with a default setting of 0 seconds to a maximum of 600 seconds (10 minutes). The delay is only available in the Standby or Inverter modes. Once the Alpha Micro 100 returns to the Line mode, the delay resets to 0 seconds.

**Inverter Cutoff Enable/Disable**

Enabled: the user configured inverter cutoff threshold is used.  
 Disabled: the default Alpha Micro 100 inverter cutoff threshold is used.

**Inverter Cutoff Threshold**

Defines the point where the unit will switch from Inverter to Standby when the battery is considered to be low or in order to preserve the battery.

The inverter cutoff threshold is configurable in 0.1Vdc increments according to the battery voltage as described in the following table.

Parameter	24Vdc Battery		
	Default	Minimum	Maximum
Inverter Cutoff (Vdc)	21.5	21.5	23
Battery Low Warning Threshold (Vdc)	Vset + 1		

**UPS Maintenance > Relay and Load Shed:** The Alpha Micro 100 has two dry contacts (C1 and C2) on the front panel which can be configured by the user to open or close based on the specific trigger conditions. See Table Q on page 67 for a description of all available dry contact functions.

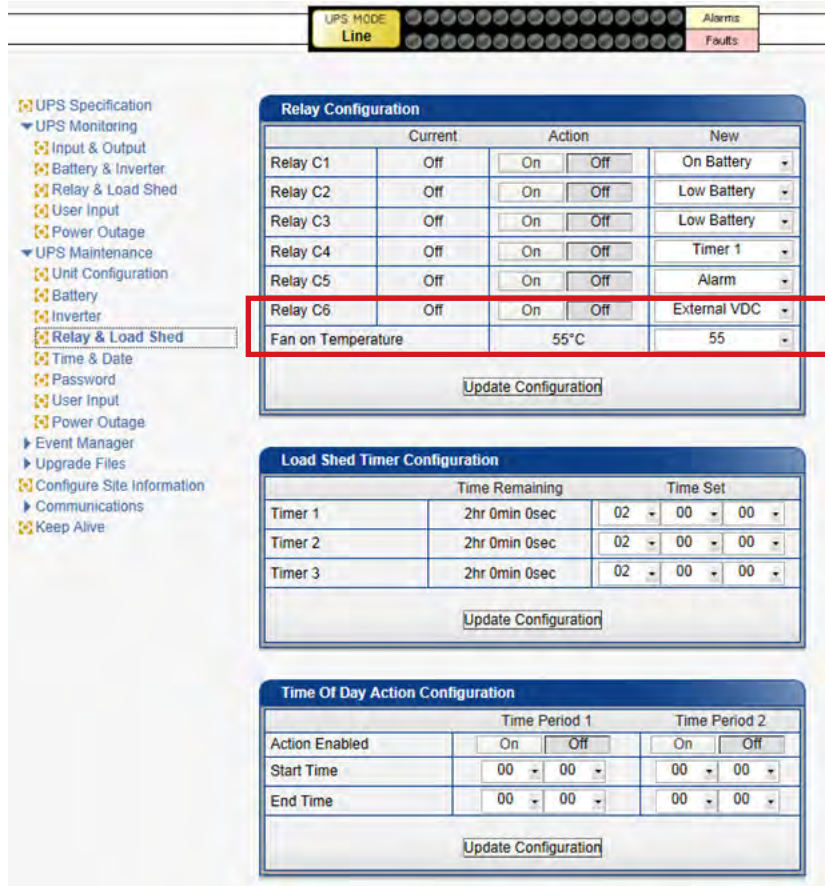

C3-C6 not available on the Alpha Micro 100.

Figure 27 — UPS Maintenance: Relay and Load Shed Screen

### Programmable Dry Contact Time of Day Action

You can assign a dedicated timer to a dry contact. Upon entering the Inverter operating mode, the timer is activated and begins to count down from a user defined value. When the timer reaches zero, the programmed dry contact relay is activated (Status = ON).

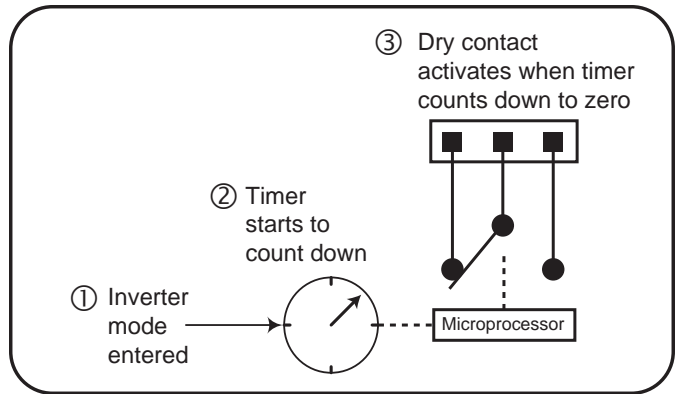

Figure 28 — Programmable Timer Operation

An example of a typical application of this timer-controlled dry contact function is control of a traffic light. When the grid power fails, the Alpha Micro 100 goes into the Inverter mode and continues supplying backup power to the traffic light. Since the batteries supplying the backup power have limited capacity, a timer controlled dry contact is usually configured to switch the traffic light into the flashing amber or flashing red mode after a user-defined period to conserve battery power.

This setup works for non-rush hour traffic, but during rush hour, it may be desirable to keep the traffic light running normally as long as backup power is available. To address this issue, a new feature called the **Time of Day Action** has been added to deactivate the timer during a user defined time period up to twice each day.

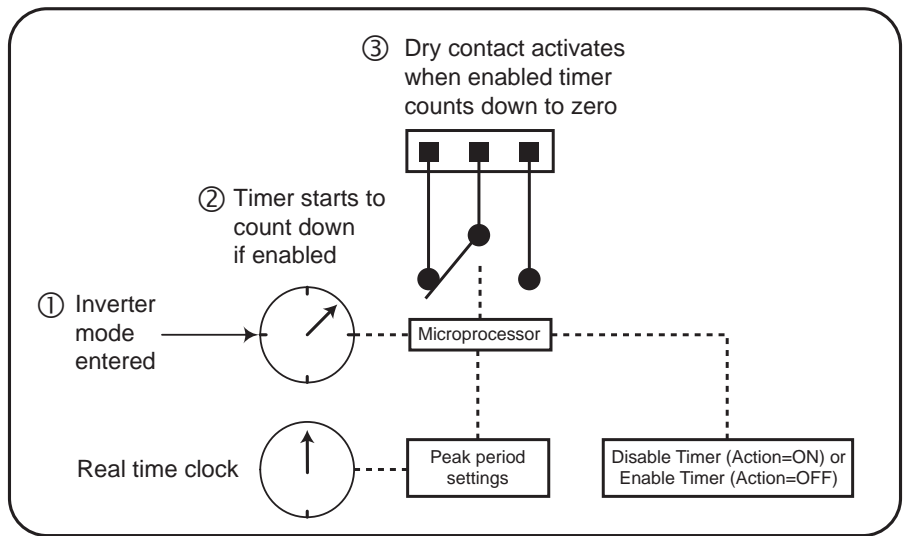

Figure 29 — Time Of Day Action Operation



You can define up to two peak time periods of the day in the **Maintenance > Relay and Load Shed** screen:

1. In the **Time of Day Action Configuration** dialogue box, set up the start and end time of the first rush hour under **Time Period 1** and the second rush hour under **Time Period 2**. In this example, during the first time period (7 AM to 9 AM), all 3 timers are disabled (they do not count down at all). Similarly, all timers are disabled during the second time period (3 PM to 6 PM).
2. Select **ON** under each time period. Click the **Update Configuration** button under the time periods to store the settings.

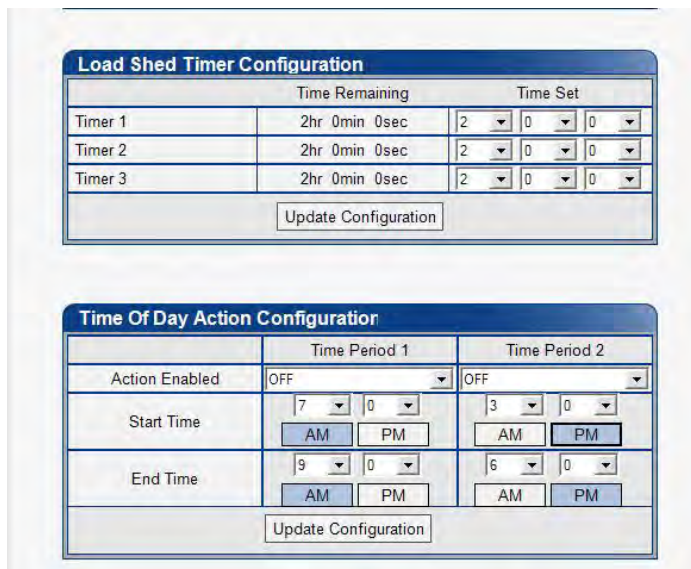

Figure 30 — Time Of Day Configuration

3. Confirm your settings in the **UPS Monitoring > Relay and Load Shed > Time of Day Action Status** screen. Once the **Time of Day Action** is configured, the Alpha Micro 100 will automatically disable the timers during the Inverter mode at the defined peak periods.

You can switch off the **Time of Day Action** by setting one or both time period(s) to **OFF** (Figure 46). The dry contact will be activated by the timer regardless of the peak period settings.



C3 to C6 are not available on the Alpha Micro 100.

Figure 31 — Time Of Day Action Status

**UPS Maintenance > Time and Date:** used to set the Alpha Micro 100 date and time.

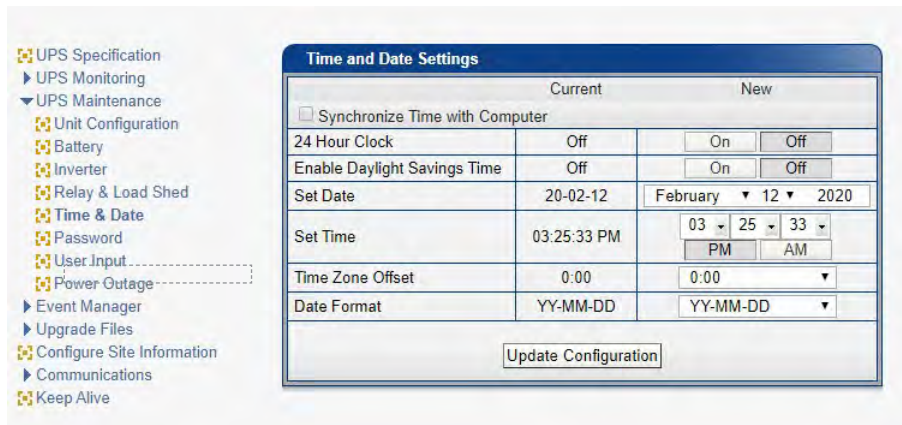

Figure 32 — UPS Maintenance: Time and Date Screen

**UPS Maintenance > Password:** used to reset the Alpha Micro 100 password, which is limited to 4 alphanumeric characters. The factory set password is 1111.



Figure 33 — UPS Maintenance: Password Screen

## UPS Maintenance > Power Outage

Users can set up a time-in-minutes, during which, the unit will ignore any power outages ( $V_{in} = 0V_{ac}$ ) of shorter durations to avoid logging nuisance alarms. The default time is set to 1-minute.

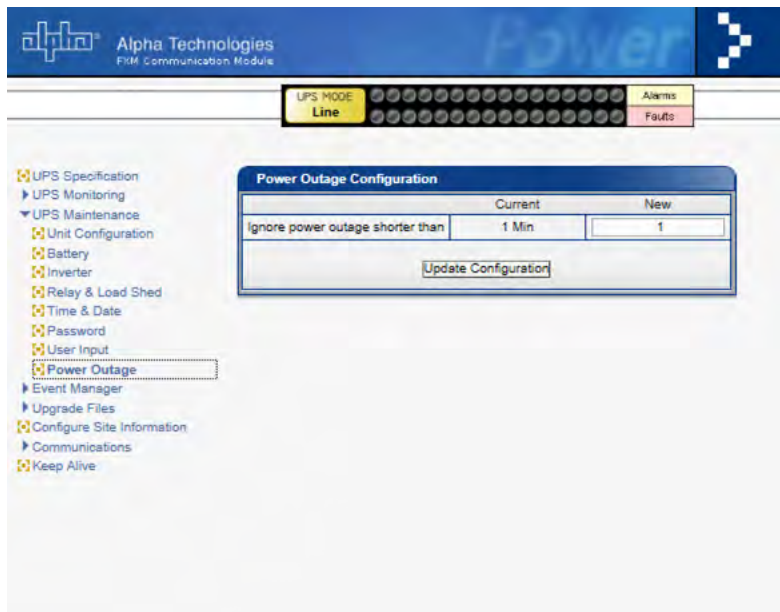

Figure 34 — Power Outage Configuration

## 9.5.6 Event Manager

### Alarms and Faults

This read-only screen shows the operating status of the Alpha Micro 100. When the fault or alarm indicators on the horizontal bar are illuminated, place the mouse cursor over the light to display the context sensitive message.

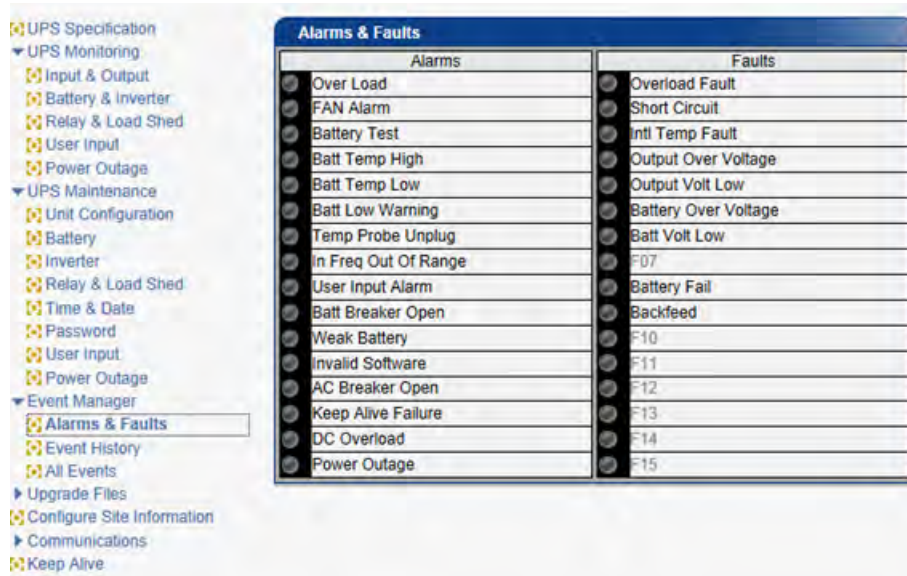

Figure 35 — Alarms and Faults Screen

### Event History

This screen shows the last 200 events recorded by the Alpha Micro 100. Choosing a number in the **Event Index** drop-down box and then clicking on the **View Selected** button displays the updated information about the selected event.



Figure 36 — Event History Screen



## All Events

1. To see the latest events, click **Get Events** and wait for the latest events to download from the FXM. It might take a couple of minutes to download all of the events to the web page (depending on the total number of events). If you leave the page before the download is finished, you will have to start over when you come back.

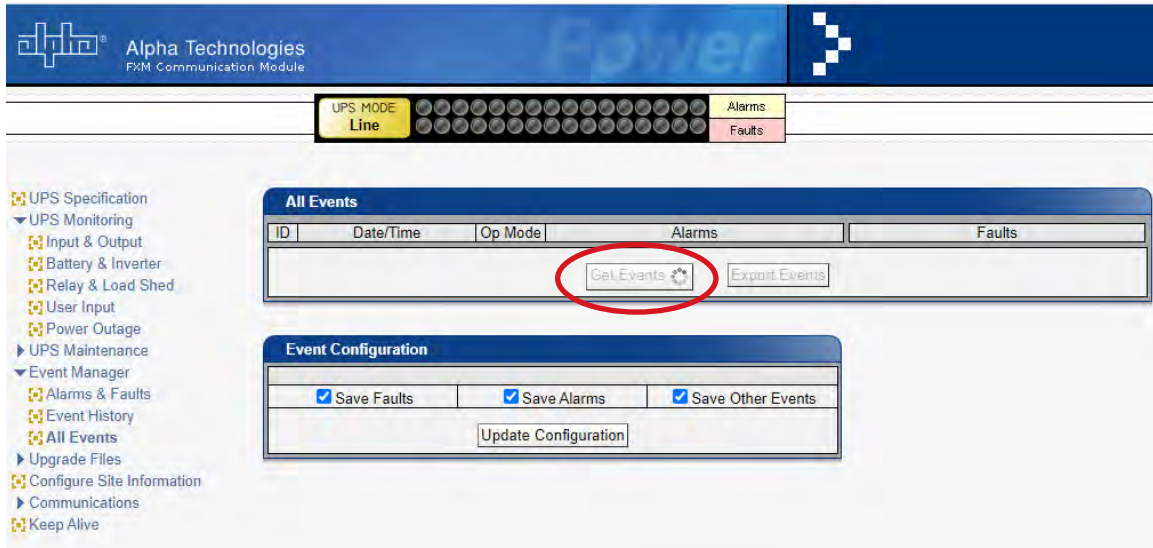

Figure 37 — Event Manager > All Events

2. To save the event log once all events are downloaded click on **Export Events** to save to .csv file.
3. To choose which events are logged, click the check boxes in the Event Configuration screen. Once an alarm is disabled, then no new alarms will appear in the event log. All alarms that were saved prior to disabling alarms are still in the event log. Email notifications will also cease for any of the disabled alarms/faults/other events – see "Figure 43 — Email Notification Screen" on page 54.

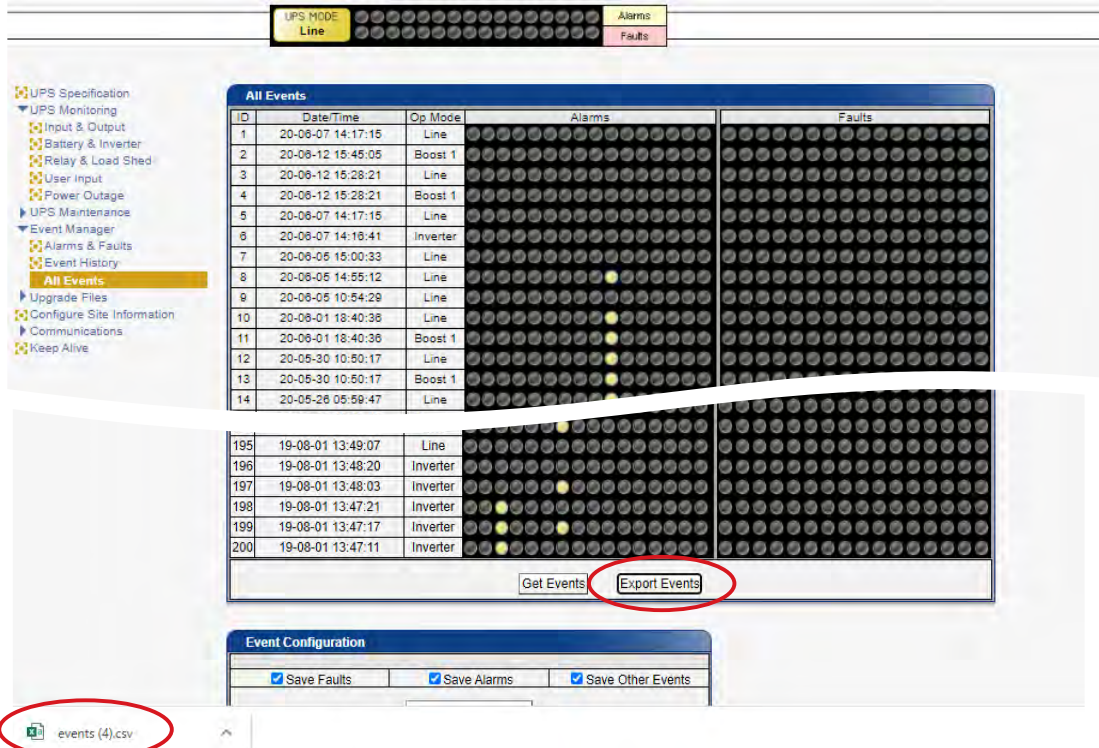

Figure 38 — Event Manager > Export Events

## 9.5.7 Upgrade Files

When upgrade files are available, either the microprocessor PCB that controls and monitors the Alpha Micro 100 or the Alpha Micro 100 communication module can be upgraded.

To upgrade the microprocessor, use Upgrade FXM Firmware and then browse to the appropriate .fbin file and press send file. The upgrade will not affect the operation of the UPS

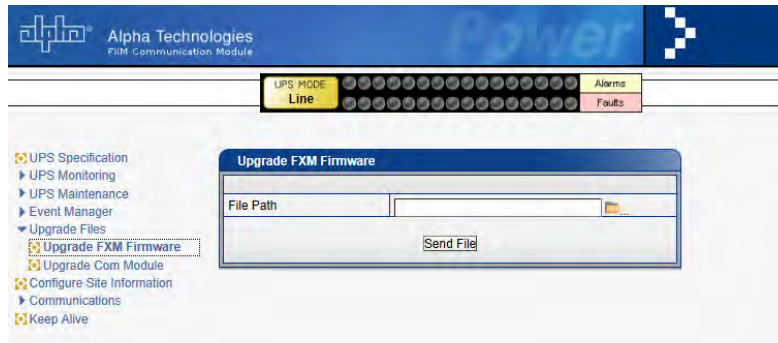

Figure 39 — Alpha Web Interface: Upgrade Firmware

To upgrade the Communication module, browse to the .ezip file and click OK to start the upload. This may take a few minutes to complete. Once complete the communication module may perform an auto restart. Communication may be lost temporarily.

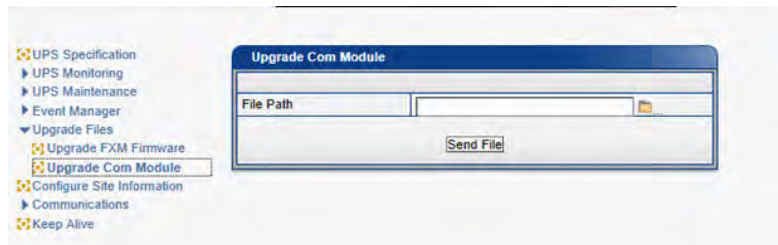

Figure 40 — Upgrade Communication Module

## 9.5.8 Configure Site Information

This screen is used to enter site location information into the UPS memory.

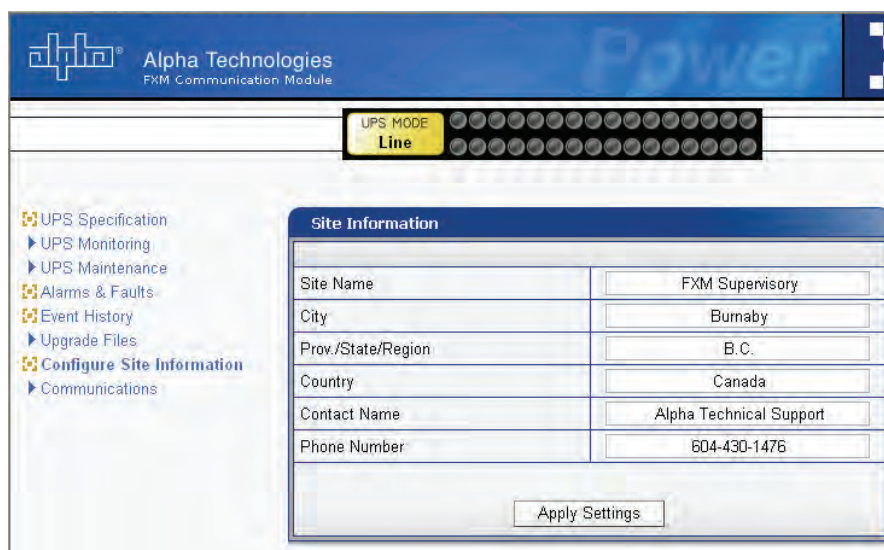

Figure 41 — Site Information

## 9.5.9 Communications

### Configure TCP/IP

See section "9.5.1 Installation and Set Up" on page 38.

### Configure SNMP

Configure SNMP is used to set the UPS for use with SNMP communications.

SNMP Settings	
SNMP Community	public
SNMP Trap Port	1162
Broadcast	<input checked="" type="checkbox"/>
SNMP Trap IP Address	255.255.255.255

Apply Settings

Figure 42 — Configure SNMP Screen

### Email Notification

#### NOTE:

The FXM communications module does not pass authentication details to the SMTP server. You must enable anonymous authentication in the SMTP server to allow the FXM to email anonymously.

Enabling Email Notification sends an email message whenever selected UPS events happen. (See page 52 to configure logged events.)

To create up to 4 different destinations, click **Add Destination** and then fill in the required fields:

- Enter a **To** address.
- Check off at least one of the **Notify** boxes.
- **CC** and **Subject** fields are optional.

#### NOTE:

Email destinations can only save up to 63 characters. More than 63 characters can be typed, but only the first 63 characters will be saved.

To edit an existing destination, select the destination by clicking on it.

To remove a destination, click on the destination and click **Remove Destination**.

Email Destinations	
Add Destination Remove Destination	

SMTP Server Settings	
Username	
Password	
SMTP Server Address	
SMTP Server Port	
From Address	

Apply Settings

Figure 43 — Email Notification Screen



## Test Email

The **Test Email** feature tests the operation of the email notification option. Mail server settings can be tested as well.

1. Select **Communications > Test Email**.
2. If settings have already been saved with the Email Notification option, they will appear under:
  - **Test Email Server Settings** (with a check mark next to **Same as Email Notification**) and
  - **Test Email Destinations**
3. If necessary, modify the mail server settings and press the **Update Configuration** button to save the settings.
4. In the **Test Email Destinations** box, use the default email address or add one if none is specified. Add a subject and test message.
5. Press the **Start Email Test** button.
6. When the test starts running, log messages are displayed in **Test Email Log** text area.
7. If after the test is finished, the test email does not arrive at its destination, copy the text from the **Test Email Log** and email it to Alpha's tech support: alpha@alpha.com.

The screenshot displays the Alpha Technologies FXM Communication Module web interface. At the top, there is a blue header with the Alpha Technologies logo and the text "Alpha Technologies FXM Communication Module". Below the header, there is a status bar showing "UPS MODE Buck 2" and "Alarms Faults". The main content area is divided into several sections:

- Test Email Server Settings:** This section contains a table with the following fields: "Same as Email Notification" (checked), "Username", "Password", "SMTP Server Address", "SMTP Server Port", and "From Address". Below the table is an "Update Configuration" button.
- Test Email Destinations:** This section contains a table with the following fields: "To:", "CC:", "Subject:", and "Message:". The "Message:" field contains the text "This is FXM test email.". Below the table is a "Start Email Test" button.
- Test Email Log:** This section contains a table with the text "No Test in Progress".

On the left side of the interface, there is a navigation menu with the following items:

- UPS Specification
- UPS Monitoring
- UPS Maintenance
- Event Manager
- Upgrade Files
- Configure Site Information
- Communications
  - Configure TCP/IP
  - Configure SNMP
  - Email Notification
  - Test Email
  - Keep Alive

Figure 44 — Test Email Feature



## 9.5.10 Keep Alive

Activation of the Keep Alive feature provides a method to restore communications when a communication failure is detected. A reset temporarily removes power and resets the local communications equipment powered by this unit.



### CAUTION!

**Enabling the Keep Alive feature will cycle power at the output. Equipment connected to the UPS will lose power momentarily.**

- UPS Specification
- UPS Monitoring
- UPS Maintenance
- Event Manager
- Upgrade Files
- Configure Site Information
- Communications
- Keep Alive

Keep Alive Status/Manual Control		
	Current	New
Status	Off	<input type="checkbox"/> On <input checked="" type="checkbox"/> Off
Delay To Startup	300 Sec	<input type="text" value="300"/>
<input type="button" value="Update Configuration"/>		

Keep Alive Method To Detect Communication Failure		
	Current	New
Protocol	Ping	<input type="text" value="Ping"/>
IP Address	0.0.0.0	<input type="text" value="0.0.0.0"/>
Delay Between Retry	15 Sec	<input type="text" value="15"/>
<input type="button" value="Update Configuration"/>		

How To Detect Communication Failure		
	Current	New
Timeout	10 Sec	<input type="text" value="10"/>
Retries Before Failure	3	<input type="text" value="3"/>
<input type="button" value="Update Configuration"/>		

Keep Alive Action To Attempt To Restore Communication		
	Current	New
Action	Reset All Power	<input type="text" value="Reset All Power"/>
Action Duration	30 Sec	<input type="text" value="30"/>
<input type="button" value="Update Configuration"/>		

When To Fail		
	Current	New
After X Consecutive Actions	3	<input type="text" value="3"/>
<input type="button" value="Update Configuration"/>		

Keep Alive Failure		
	Current	New
Send Trap	On	<input type="checkbox"/> On <input checked="" type="checkbox"/> Off
Delay To Re-Startup	300 Sec	<input type="text" value="300"/>
<input type="button" value="Update Configuration"/>		

## Keep Alive status/manual control:

- a. The **Status** field allows the user to enable or disable the Keep Alive function. (When disabled, the alarm is cleared.) When the function is **On**, the **Current** column displays the status:
  - Startup Delay
  - Pinging
  - Ping Echo Received
  - Timeout total\_number\_of\_retries/current\_retry\_number
  - Reset total\_number\_of\_retries/current\_retry\_number
  - Reset Complete
  - Failure
  - Failure: Startup Delay
  - Failure: Pinging
- b. The **Delay to Startup** field allows the user to set the time to the first ping from the enable ping or UPS restart after a ping failure. Minimum = 5 sec, Maximum = 3600 sec.

## Keep Alive Method to detect communication failure:

- a. Ping is the only option in the Protocol field.
- b. In the **IP Address** field, enter the IP address of this Alpha Micro 100.
- c. In the **Delay Between Retry** field, enter the delay between pings: minimum = 5 sec, maximum = 65535 sec.

## How to detect communication failure:

- a. In the **Timeout** field, enter the ping timeout. Minimum = 2 sec, Maximum = 65535 sec.
- b. In the **Retries Before Failure** field, enter the number of pings to repeat before power cycling. Minimum = 1, Maximum = 20.

## Keep Alive action to attempt to restore communication:

- a. The **Action** field has 3 options: reset all power (AC and DC), reset AC power, and reset DC power. This action resets the power for the duration set in Step b. DC reset occurs when one dry contact is set to **LVD**.
- b. The **Action Duration** field is how long the output will be shut off by the UPS, Minimum = 5 sec, Maximum = 3600 sec.

## When To Fail:

- a. The **After X Consecutive Actions** field determines the number of times the UPS will go through the ping and power down and back up cycle before registering an alarm for Keep Alive. Other alarms and events will occur regardless of this value. After the final power cycle, the UPS will issue another ping after the Delay between retry has elapsed. This ensures the destination IP is not alive. The UPS will then set the Keep Alive alarm. Minimum = 1, Maximum = 20.

## Keep Alive Failure:

- a. The Send Trap field allows the email and SNMP trap notification to be switched on and off for the Keep Alive only.
- b. The Delay to Re-Startup field configures the delay after the Keep Alive alarm is set and the next ping is sent in delay to restart. Minimum = 5 s, Maximum = 3600 s.

## 9.6 Alpha UPS Monitor Interface: Communication via USB

The Alpha UPS Monitor graphical user interface (GUI) provides web-like or Windows-like computer communications with the Alpha Micro 100. It can be connected to a computer with a USB cable (USB-A to USB-B). The screen and its features, shown in below, are used to monitor, control and set various parameters like the date and time, determine when to perform a weekly self test, change the relay configurations, etc. The on line indicator (F) shows if you are connected to the Alpha Micro 100

The Alpha UPS Monitor automatically polls the Alpha Micro 100 to obtain its status. If a light or lights are illuminated in the Fault or Alarm fields, the Alpha Micro 100 has a malfunction. Hover your mouse cursor over the light to learn the type of malfunction or double-click on it to go straight to the Alarms and Faults screen.

To control the unit or change settings or parameters, either click on the On/Off buttons, or choose an item from a drop down menu. Then click on the **Update Configuration** button. If you do not click on this button, the change will not happen.

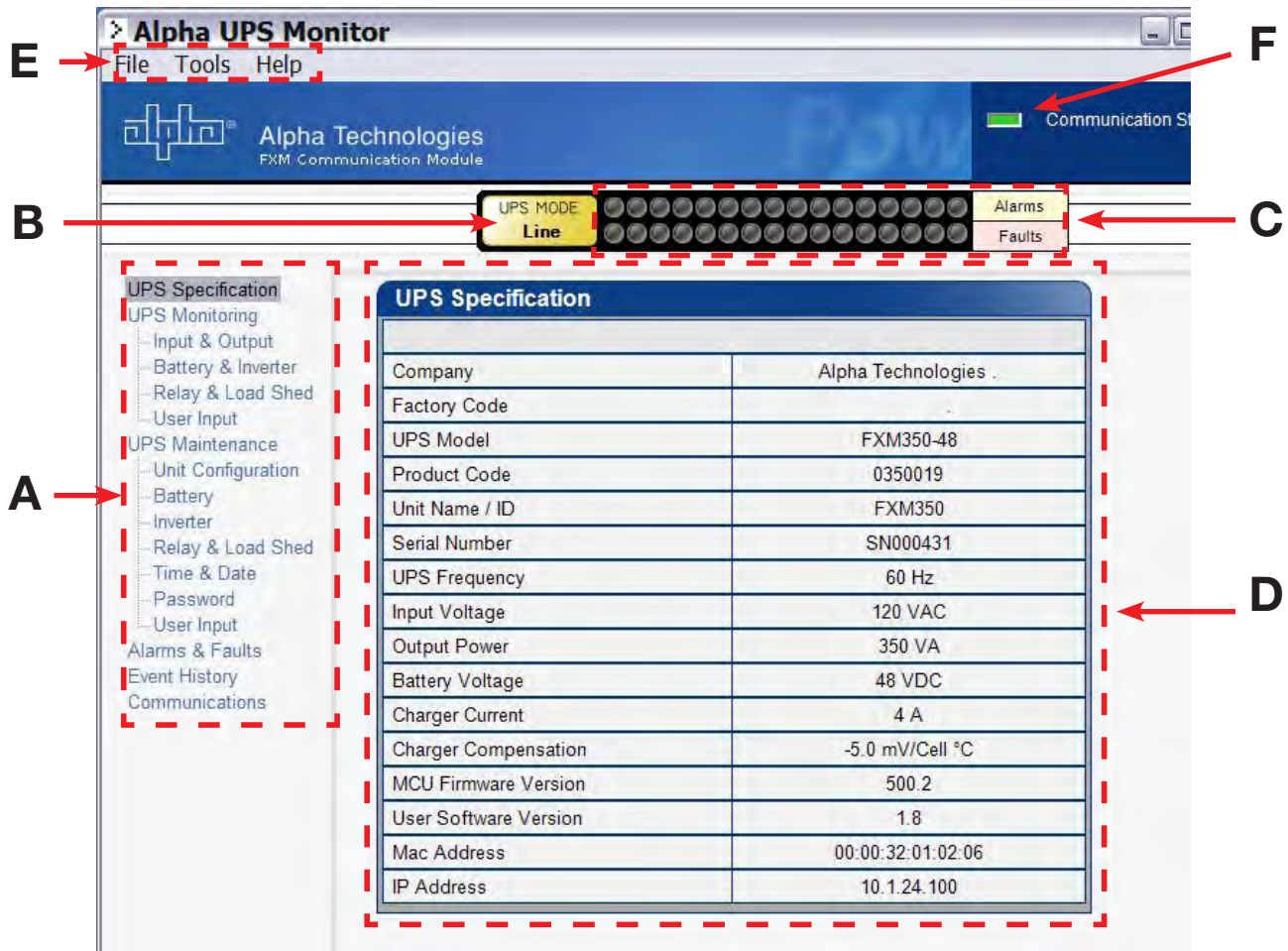

A	Screen selection menus
B	Current UPS operating mode. Updates automatically.
C	Fault and alarm indicators – when a light in this bar is illuminated, move the mouse cursor over the light to determine the malfunction. Double-clicking on the light will send you to the Alarms and Faults screen.
D	Readout screens
E	Drop-down menus
F	Online indicator

Figure 46 — Alpha UPS Monitor (UPS Specification Screen shown)

## 9.6.1 Installation and Set Up of the Alpha UPS Monitor

The following tools and materials are required:

- Alpha UPS Monitor, available for download from [www.alpha.ca.>serviceandsupport>](http://www.alpha.ca.>serviceandsupport>) software and firmware downloads
- Windows 2000 or later with Microsoft .NET framework installed
- USB computer cable (USB-A to USB-B)

### Checking Your Windows Computer for the .NET Framework

1. Click on the **Start** button.
2. Go to and click on **Settings**.
3. Click on **Control Panel**.
4. Double-click on the **Add or Remove Programs** icon.
5. Scroll through the list of applications. If Microsoft .NET Framework is already in the list, Framework is already installed and you can install the Alpha UPS Monitor. If you don't see it listed, you **MUST** install it from the Microsoft Windows update web site before installing the software.

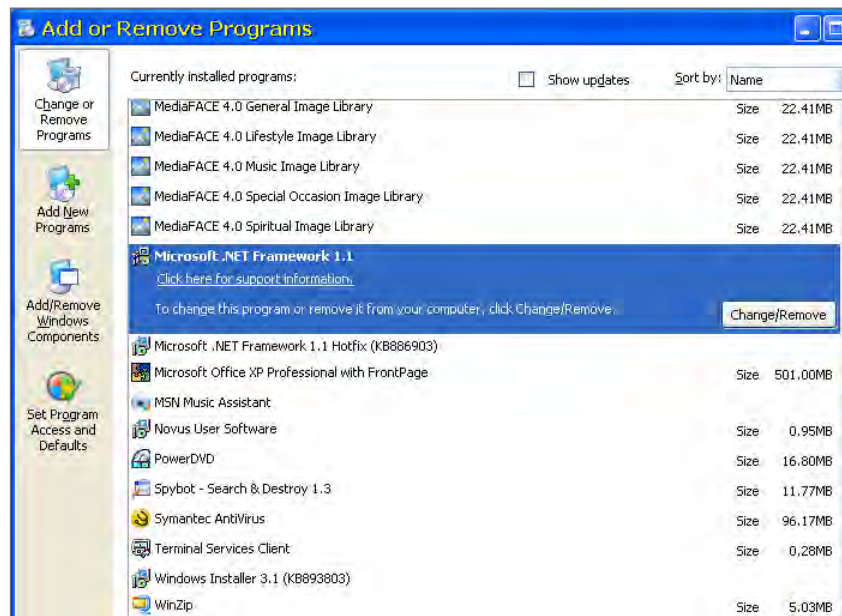

Figure 47 — Add or Remove Programs Window

### Alpha UPS Monitor Installation Procedure

1. Install the Alpha UPS Monitor onto your computer. Restart the computer.

If you install the Alpha UPS Monitor on a version of Windows without the .NET framework installed, an error message saying the framework is not installed will appear. Install the framework onto your computer, restart your computer, and then try again to install the Alpha UPS Monitor.

2. Connect the computer cable from any USB communications port on the computer to the USB port on the Alpha Micro 100 front panel.
3. To start communications between the computer and the Alpha Micro 100 do one of the following:
  - Click on the screen's Online Indicator,OR
  - In the **File** drop-down menu, click on **Connect to Micro 100**.

If the computer cannot connect to the Alpha Micro 100 a pop up screen appears asking you to check the wiring and your connection to the proper USB port.



## 9.6.2 Alpha UPS Monitor Functions

Alpha UPS monitor is similar to the web interface but not all new features are implemented on it. Some parameters can only be adjusted via web interface.

## 9.6.3 Saving Events

To build a complete history of events for an Alpha Micro 100 save all the downloaded events from the unit to the same event file. A maximum of 200 events can be stored on the Alpha Micro 100. The oldest events are replaced by the newest ones. However, saving to the same event file gives the option of appending to an existing event file when selecting **File > Save As**.

To view a previously saved event log without downloading any new events from the Alpha Micro 100 and overwriting the saved event file, select **File > Open** and navigate to the saved event log file.

When opening or saving event log files, only files with the extension “evt” can be opened or closed. This is the file type associated with event log files in the Alpha UPS Monitor.

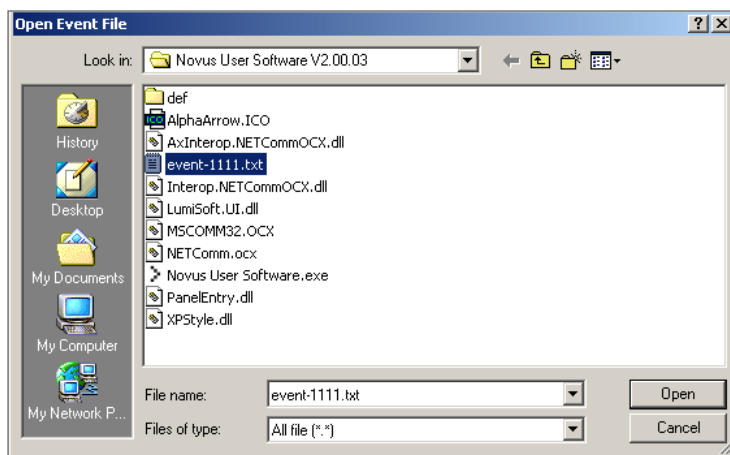

Figure 48 — Event Log Monitor, Open Event File window

There are two additional alarms displayed in newer versions of the firmware: DC Over load and Power Outage. An example from Alpha Micro 100 Event is shown in the following screen. A lighted, simulated LED graphic displays the details of the Alarm or Fault.

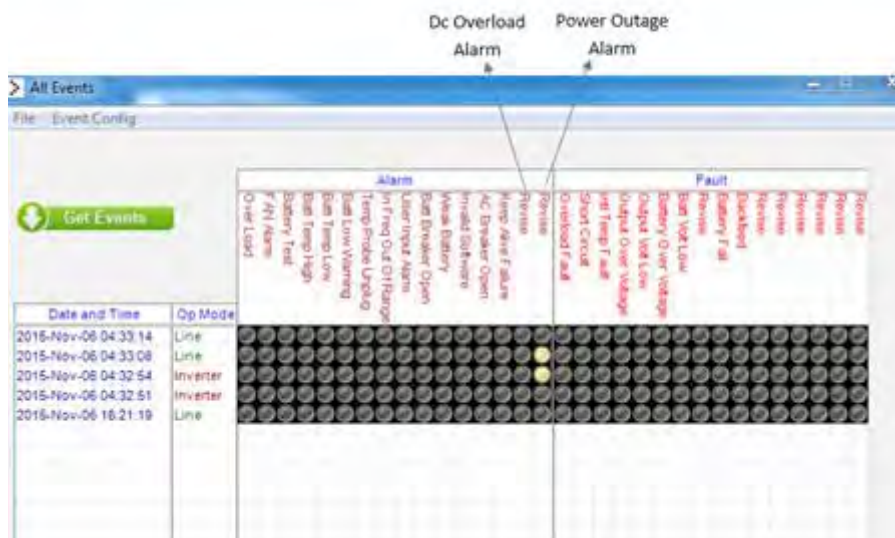

Figure 49 — Sample Event Log, Displayed in the UPS Monitor

## 9.7 HyperTerminal Interface

The Alpha Micro 100 front panel has a USB connector. When connected to a PC with Windows® HyperTerminal or other terminal emulation software, the Alpha Micro 100 can be monitored and controlled with the HyperTerminal command-line system.

HyperTerminal is a Windows application that helps to connect your computer to other remote computers using one of the USB com ports. The Micro 100 has a USB port, not an RS232 port. When the USB device's driver is implemented as a virtual com port it can be used as a normal com port

The HyperTerminal program is included in the Windows 2000 or Windows XP operating systems. Running HyperTerminal on any other operating system requires a 3rd party application designed for this purpose.

The following subsections describe the operation of the Alpha Micro 100 via the USB interface:

- Using the Main menu
- Adjusting and controlling the Alpha Micro 100
- Programming the dry contacts and the clock
- Viewing the 200-event log

### 9.7.1 Connecting to a PC with a USB Cable

1. Connect a USB-B, fully shielded, connector cable between the computer port and the Alpha Micro 100 port.
2. Configure the communications parameters as follows:
  - a. Windows 2000 or XP, go to **Control Panel > System** then select the **Hardware** tab.
  - b. Click **Device Manager**.
  - c. Find and right-click on the USB serial port.
  - d. Select **Properties** from the menu then select the **Port Settings** tab.
  - e. Set the fields as shown.

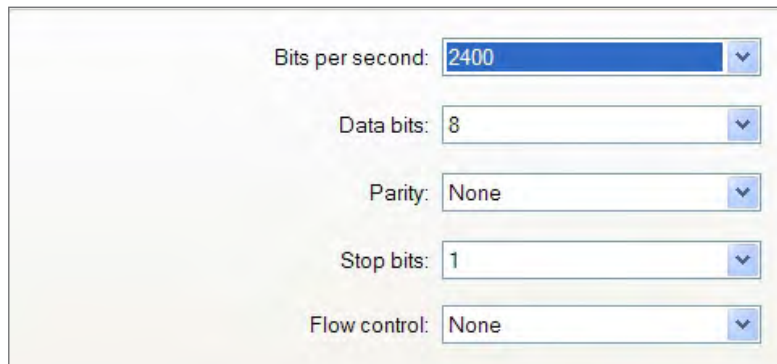

The image shows a screenshot of the HyperTerminal Communication Parameters dialog box. It contains five settings, each with a dropdown menu:

- Bits per second: 2400
- Data bits: 8
- Parity: None
- Stop bits: 1
- Flow control: None

Figure 50 — HyperTerminal Communication Parameters

## 9.7.2 Main Menu Screen

Once HyperTerminal is open, ensure that the Alpha Micro 100 has connected to the computer. See Figure 51 for connection indicators.

The main menu screen shows the Alpha Micro 100 current input and output values, displays any faults or alarms and gives access to the submenus. The Alpha Micro 100 is controlled by submenu 3.

To access a particular submenu, type in the submenu number and press **Enter**. To update the main menu screen, press **Enter**.

The complete menu tree is shown in Figure 52. There are also tables describing the Line Status (Table L), Output Status (Table M), Faults (Table N) and Alarms (Table O).

- a. The readings on the main menu screen do not automatically update to reflect changes in the Alpha Micro 100 status. Press **Enter** to update the screen.
- b. For many functions you need to enter a password. The factory setting is **1111**.

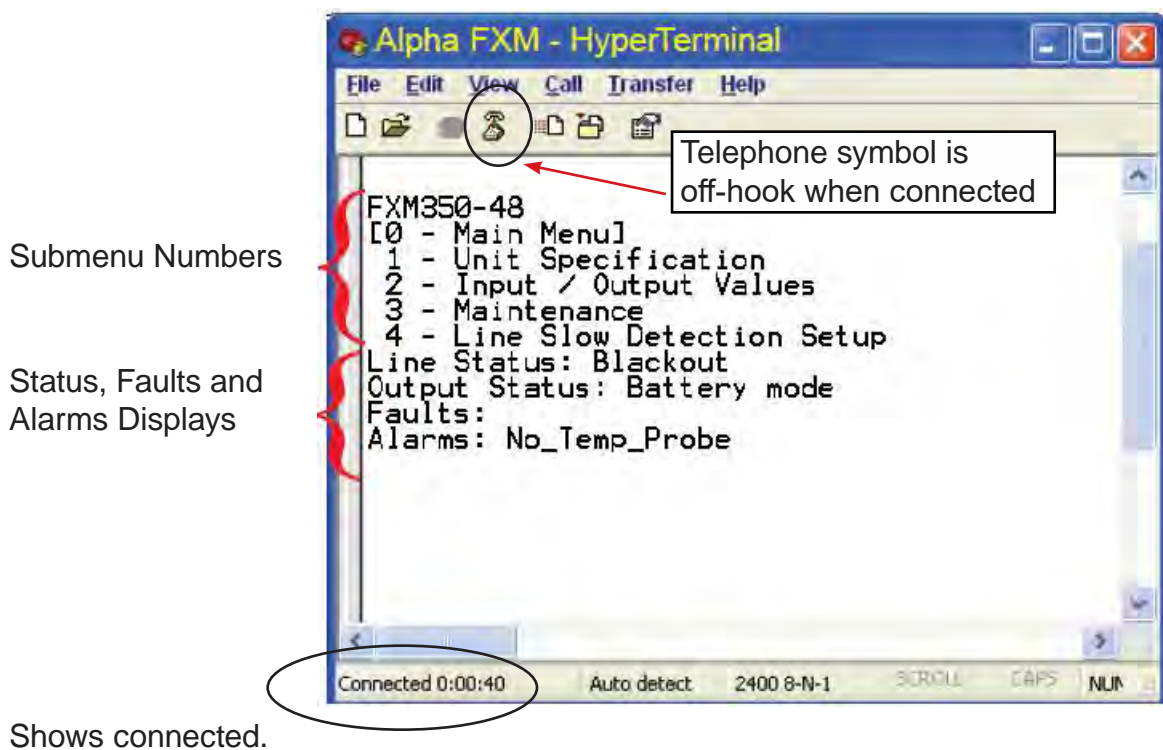

Figure 51 — Main Menu Screen

## Main Menu Screen — Submenus

Submenus #1, 2 and 4 are read-only screens for monitoring. To control the Alpha Micro 100 use submenu #3, the Maintenance submenu.

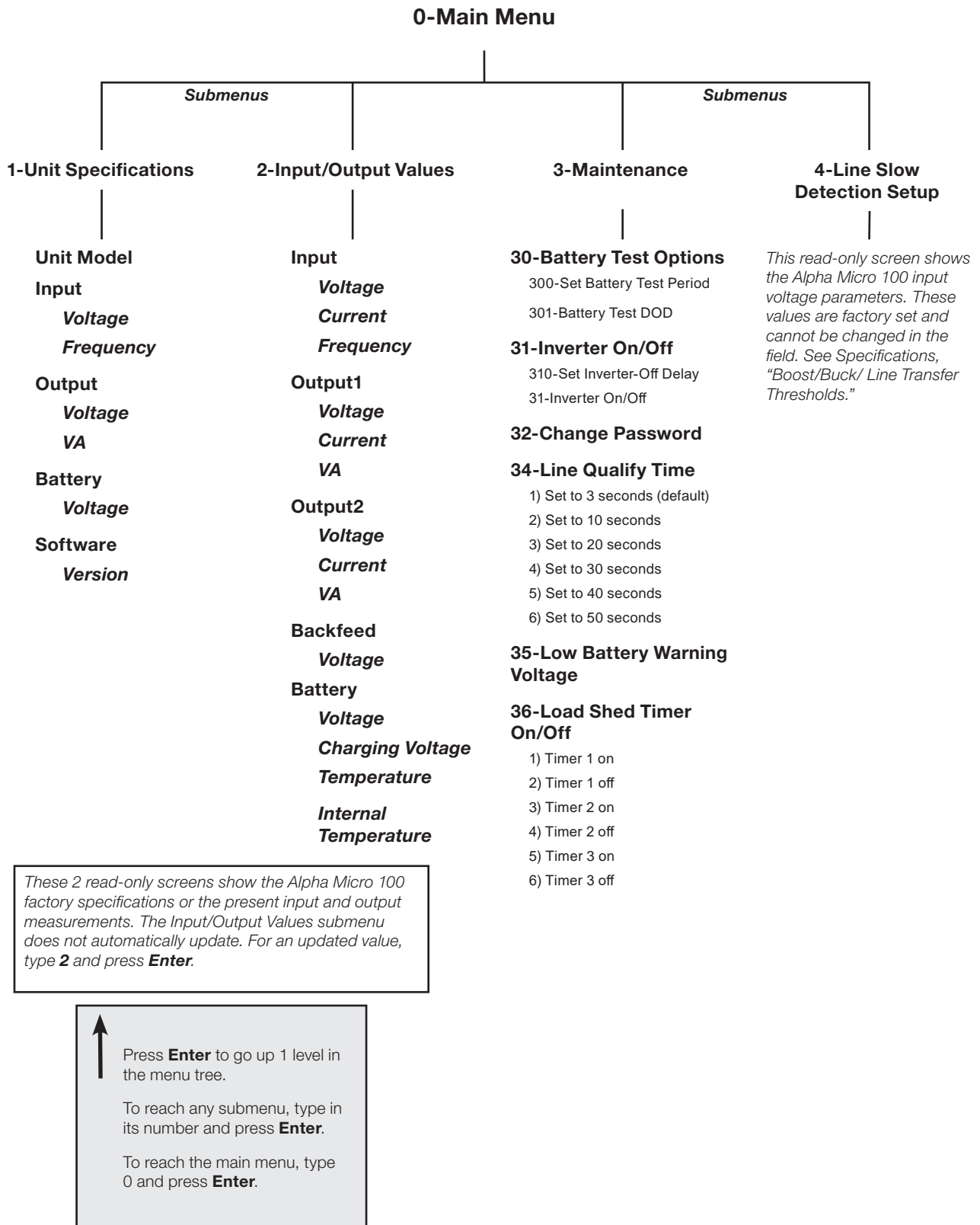

Figure 52 — Menu Tree



## Main Menu Screen — Line Status

Line status line reports the line condition. For an updated value, press **Enter**.

<b>Normal</b>	The line is within specifications. See specifications, “Boost/Buck/Line Transfer Thresholds”. The Alpha Micro 100 is operating in Line mode.
<b>Boost</b>	Line voltage is out of tolerance. The Alpha Micro 100 is operating in Boost mode.
<b>Buck</b>	Line voltage is out of tolerance. The Alpha Micro 100 is operating in Buck mode.
<b>Blackout</b>	The line is absent.
<b>Freq low</b>	Line frequency is too low.
<b>Freq high</b>	Line frequency is too high.

## Main Menu Screen — Output Status

Output status line reports how the Alpha Micro 100 is producing power. For an updated value, press **Enter**.

<b>Line mode</b>
<b>Battery mode</b>
<b>Battery mode, low bat. warning</b>
<b>Battery mode (testing battery)</b>
<b>Battery bypass mode</b>
<b>Boost mode</b>
<b>Boost 2 mode</b>
<b>Buck 2 mode</b>
<b>Hot swap mode</b>
<b>Inverter off due to fault</b>
<b>Inverter off due to low battery</b>
<b>Inverter off at start-up</b>
<b>Shutdown due to user request</b>

## Main Menu Screen — Fault and Alarm Displays

Faults and alarms display on the main menu screen. See Chapter "12. Troubleshooting".

**Table N — Faults (see Figure 51)**

<b>Table N — Faults (see Figure 51)</b>	
<b>Short_Circuit</b>	The load has a short.
<b>Vout_Hi</b>	The output voltage is above specifications.
<b>Batt_Hi</b>	The batteries cannot be charged.
<b>Batt_Lo</b>	The batteries are almost discharged.
<b>Vout_Lo</b>	The output voltage is below specifications.
<b>Overload</b>	The Alpha Micro 100 is overloaded. Remove excess loads.
<b>Backfeed</b>	A relay inside the Alpha Micro 100 has failed and it cannot be replaced in the field. Contact Alpha Technologies customer service department.
<b>Bad_Battery</b>	The battery voltage has dropped below a specified level. Inverter shuts down.
<b>Temp_Hi</b>	The Alpha Micro 100 is operating above temperature range.

**Table O — Alarms (see Figure 51)**

<b>Table O — Alarms (see Figure 51)</b>	
<b>Batt_Low</b>	The battery voltage is low.
<b>Keep_Alive</b>	The Alpha Micro 100 keep alive feature failed to restore communication.
<b>Line_Freq</b>	The line frequency is outside of the Alpha Micro 100 input specifications.
<b>Overload</b>	The Alpha Micro 100 is overloaded. Switch off excess loads.
<b>Self_test</b>	The Alpha Micro 100 is performing self test.
<b>Temp_Hi</b>	The ambient battery temperature is too high.
<b>Temp_Lo</b>	The ambient battery temperature is too low.
<b>Weak_Battery</b>	The battery has failed the background scan in Line mode.
<b>Power_Outage</b>	The input power to the UPS is not present. User can set up time in minutes during which unit will ignore any power outages of shorter durations to avoid nuisance alarm.
<b>DC_Overload</b>	When a battery string is charging, the status of the battery voltage is checked every three minutes. An alarm is generated if the voltage continues to drop while charging.

### 9.7.3 Adjusting and Controlling the Alpha Micro 100

Use sub menu #3, the Maintenance sub menu (Figure 51 and Figure 52) to control the Alpha Micro 100 and change selected items to meet your operational needs.

From the Main menu, type **3** and press **Enter**.

**Table P – Maintenance Submenu**

<b>Table P – Maintenance Submenu</b>	
<b>30 Battery Test Options</b>	Starts the battery test and sets how long the test will run. The default setting for the test depth-of-discharge is 20%, but this can be adjusted from 0 to 100%.
<b>31 Inverter On/Off</b>	Switches the inverter on or off to allow you to prevent a damaging deep battery discharge or to provide backup battery power to the load. You can set a delay before the inverter switches off to allow time for switching off critical loads. The Set Inverter ON/OFF delay is only available when the Alpha Micro 100 is in the Battery or Standby modes. The delay can be adjusted in 1 second steps with a default setting of 0 seconds to a maximum of 600 seconds (10 minutes). The delay is only available in the Standby or Battery modes. Once the Alpha Micro 100 returns to the Line mode, the delay resets itself to 0 seconds.
<b>32 Change Password</b>	Changes the Alpha Micro 100 password. The factory set password is 1111, which can only be changed when the Alpha Micro 100 is in Line mode. The password is limited to 4 alpha-numeric characters in length.
<b>34 Line Qualify Time</b>	Lets you set the delay when the Alpha Micro 100 goes from Battery mode to Line mode after the line becomes requalified. The purpose of this delay is to make sure the line is stable before the Alpha Micro 100 switches back to it. The default setting is 3 seconds, but you can set this to 3, 10, 20, 30, 40 or 50 seconds.
<b>35 Low Battery Warning Voltage</b>	Lets you set the Alpha Micro 100 low battery warning voltage by typing in the % battery voltage level where you want the warning to be triggered. Adjust the setting to match the batteries you are using and the actual operating conditions. 24V: Default 40% - 23.5 VDC Adjusted in 1% increment – 0.025 VDC Minimum 0% - 22.5 VDC Maximum 100% - 24.8 VDC
<b>36 Load Shed Timer On/Off</b>	Lets you switch the timer contacts on or off.

## 9.7.4 Programming the Dry Contacts

The Alpha Micro 100 front panel contacts (C1 and C2) can be programmed to meet your specifications. Each contact can only be programmed for one function at a time and cannot show multiple conditions.

The functions of dry contacts can be changed with HyperTerminal. For example, to change contact C2:

To see how it is currently programmed, type **c2** (all lower case) and press **Enter**.

The Alpha Micro 100 responds with **\*c2=2** where the \* shows the unit responded to your command.

For example: a **"2"** shows it is programmed to be the **Low Battery** indicator.

To change the contact, type **c2=X** where X is 1 to 14 and press **Enter**.

The Alpha Micro 100 responds with **\*c2=(1 to 14)**. For example, to change the C2 contact to be the Temperature indicator, type **c2=11**

<b>Table Q – Dry Contact Configuration Settings</b>	
<b>1= On Battery</b>	Used for remote indication of the On Battery condition.
<b>2= Low Battery</b>	Used for remote indication of the Low Battery condition.
<b>3= Timer 1</b>	See "Setting the Timer Contact" on page 68.
<b>4= Alarm</b>	Used for remote indication of an Alarm condition.
<b>5= Fault</b>	Used for remote indication of a Fault condition.
<b>6= Disabled</b>	Dry contact is disabled, i.e. never energizes.
<b>7= Timer 2</b>	See "Setting the Timer Contact" on page 68.
<b>8= Timer 3</b>	See "Setting the Timer Contact" on page 68.
<b>9= External Vdc</b>	Not available on Micro 100.
<b>10= Generator</b>	Reserved for future use.
<b>11= Temperature</b>	Not available on Micro 100.
<b>12= Low Battery, Shutdown</b>	Contact will activate when battery is low (factory-defined level) and the unit is running in Inverter mode. Contact is deactivated when battery level returns to an acceptable value.
<b>13= Low Battery and Line</b>	Used for remote indication that the battery is low in Line mode. This condition can be used to interpret the health of the battery.
<b>14= LVD (Low Voltage Disconnect)</b>	The dry contact is energized when the battery voltage is greater than the LVD CONNECT set voltage (see "Control Parameters" on page 32) and will de-energize if the battery voltage drops below 21V.
<b>15= Output Relay</b>	The dry contact is used for energizing external output relay. The external AC contactor can be controlled for disconnect/reconnect by configuring one of the dry contacts as Output Relay. Output relay option is built-in for Micro 100.  <b>Caution:</b> On 230Vac models, any relay when configured to "Output relay" is wrongly triggered during transitions to and from Boost 1 and Boost 2 modes while in AVR Reduced mode.

## Setting the Timer Contact Interval

If you configure one of the dry contacts to act as a timer, the next step is to set the value of the timer.

Time can be entered in units of 0.5 second; e.g. 120 units of 0.5 seconds = 60 seconds. However, it is more intuitive to enter time in the hh:mm:ss format, such as 00:01:00 for 1 minute or 60 seconds. Both methods are shown in the following example.

<b>Table R — Setting the Timer Contact</b>			
	<b>Enter command</b>	<b>UPS display</b>	<b>Description</b>
Displaying the Timer	<b>timer1</b> and press <b>Enter</b>	*timer1=02:00:00	Returns the value of Timer 1
	<b>timer2</b> and press <b>Enter</b>	*timer2=02:00:00	Returns the value of Timer 2
	<b>timer3</b> and press <b>Enter</b>	*timer3=02:00:00	Returns the value of Timer 3
Setting the Timer	<b>timer1=00:01:00</b> and press <b>Enter</b>	*timer1=00:01:00	Sets the value of Timer 1 to 60 seconds.
	<b>timer1=120</b> <sup>†</sup> and press <b>Enter</b>	*timer1=120	
	<b>timer2=00:01:00</b> and press <b>Enter</b>	*timer2=00:01:00	Sets the value of Timer 2 to 60 seconds.
	<b>timer2=120</b> <sup>†</sup> and press <b>Enter</b>	*timer2=120	
	<b>timer3=00:01:00</b> and press <b>Enter</b>	*timer3=00:01:00	Sets the value of Timer 3 to 60 seconds.
	<b>timer3=120</b> <sup>†</sup> and press <b>Enter</b>	*timer3=120	
	<b>default</b> and press <b>Enter</b>	*default	Resets the timer to the factory default of 02:00:00 (2 hours); and resets contacts C1 to C5 to the factory default settings.
<p>Note: In the above example, the default timer setting of 2 hours is used.</p> <p>* Indicates that the Alpha Micro 100 has responded to the command you entered.</p> <p>† Time can be entered in units of 0.5 second; e.g. 120 units of 0.5 seconds = 60 seconds. However, it is more intuitive to enter time in the hh:mm:ss format, such as 00:01:00 for 1 minute or 60 seconds in the above example.</p>			

## 9.7.5 Setting the Date and Time

Table S — Setting the Date and Time		
Enter command	UPS display	Description
<b>clock</b> and press <b>Enter</b>	*clock=12/31/07 22:00:00	Returns the current date and time.
<b>clock=010111 _ 120000</b> and press <b>Enter</b>	*clock=01/01/11 12:00:00 <sup>†</sup>	Sets the date and time to Jan 01, 2011, 12:00 pm
<p>Notes:</p> <ol style="list-style-type: none"> <li>1. Time is displayed in the 24 hours clock format.</li> <li>2. Changing the mm/dd/yy format with DATE SEL on the Control menu does not change the USB mm/dd/yy format.</li> <li>3. If the Alpha Micro 100 has been in storage or switched off for a prolonged period, the backup Lithium coin battery could be drained and may not correctly keep a backup of the date and time you entered. After switching on the Alpha Micro 100 check the date and time settings. The Alpha Micro 100 should display the current date and time. If it displays the date as "00:01:00", then the battery is spent and you need to ask a qualified service personnel to replace the lithium coin battery. See Chapter "12. Troubleshooting".</li> </ol> <p>* Indicates that the Alpha Micro 100 has responded to the command you entered.  <sup>†</sup> If the date or time change is invalid, the Alpha Micro 100 will return the time and date it was set to before you tried making the change. The date and time must be entered as one complete line command. You cannot change only the time or the date alone. Both must be set at the same time. If you make a mistake, press <b>Enter</b> and try again.</p>		

## 9.7.6 Viewing the Serial Number

To display the serial number of the Alpha Micro 100 UPS, type "\*QY0" at the command line and press "Enter".



## 9.7.7 Setting the Peukert Number

You can set the Peukert Number using the USB interface or the web interface. To display the current Peukert Number, type "\*QY6" at the command line and press "Enter".

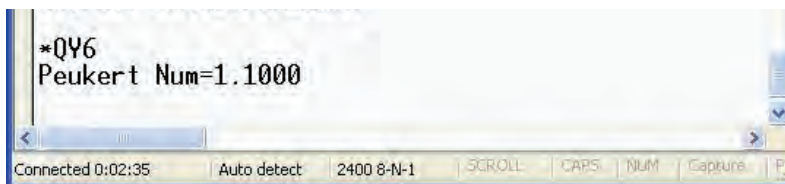

To change the Peukert Number to 1.1345, type "\*ST6:1.1345" at the command line and press "Enter".

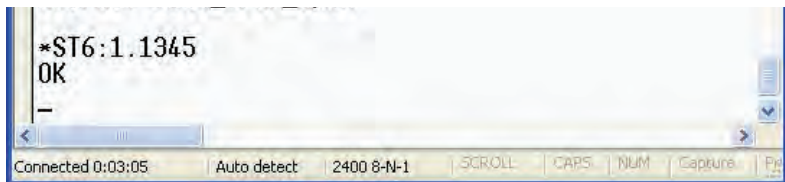

To determine the Peukert number of your battery, refer to "Peukert Number" on page 73.



## 9.7.8 200-event Log

Up to 200 events are stored in the Alpha Micro 100 log. If more than 200 events occur, the oldest is over-written.

### Procedure:

- To see the log, type **event** (all lower case) and press **Enter**. The events are listed starting with the most recent and appear as:

```
eventX=12/25/99 01:45:59 0000000000000000, 0000000000000000, 000
Event   Date   Time   Alarm   Fault   Mode
```

Date and Time formats depend on selected display format      See below for details on these readouts.

Alarm: When the following bits show a 1, the following alarms are displayed.

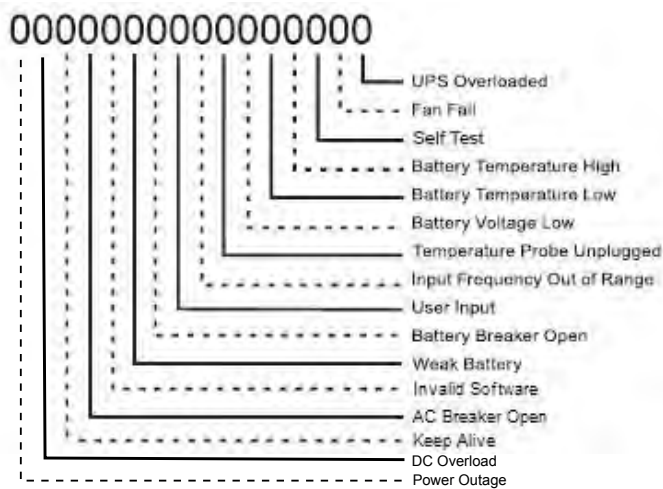

Fault: When the following bits show a 1, the following faults are displayed..

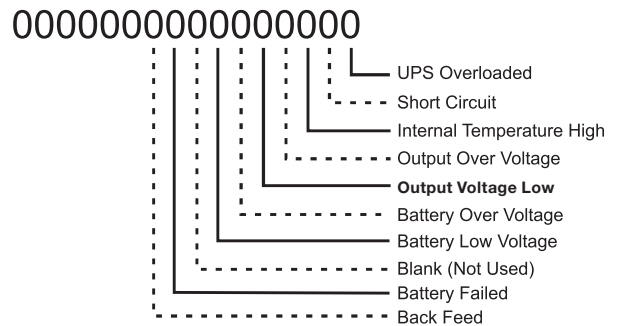

**Table T — Event Codes**

Code	Mode	Code	Mode	Code	Mode
000	Standby	003	Boost 1	006	Inverter
001	Line	004	Buck 1	009	Shutdown
002	Boost 2	005	Buck 2	010	Bypass

- If less than 200 events occurred, the last entry will appear as:

```
eventX=00/00/00 00:00:00 0000000000000000, 0000000000000000, 000
```

- To clear the log, type **eventclr** and press **Enter**. It takes the Alpha Micro 100 30 seconds to clear the log. Do not enter any other commands during this time.
- To see a specific event, type **eventX** where X is from 1 to 200 and press **Enter**. To see a range of events (for example, events 20 to 30), type **eventX-X** where X are events from 1 to 200 and press **Enter**. To clear the log, type **eventclr** and press **Enter**. It takes the Alpha Micro 100 30 seconds to clear the log. Do not enter any other commands during this time.
- To see a specific event, type **eventX** where X is from 1 to 200 and press **Enter**. To see a range of events (for example, events 20 to 30), type **eventX-X** where X are events from 1 to 200 and press **Enter**.

### 9.7.9 Restoring All Parameters to Default Values

The purpose of this command is to reset the Alpha Micro 100 to the factory default state. See Table K for a list of parameters that will be restored to their default values.



#### CAUTION!

**This command resets all parameters that are user-configurable. All previously programmed operation will be lost. Implement a backup plan for mission critical operations. This command is password protected.**

#### Procedure:

1. Type **default: all** and **press Enter**.
2. **Enter the password and the** Alpha Micro 100 returns **\*default** as confirmation.

# 10. Peukert Number

---

## 10.1 Introduction

The Alpha Micro 100 UPS units run on batteries when the AC utility power fails. In this mode, the user may want to estimate the remaining time that UPS batteries can supply power to the loads.

The battery run time remaining is calculated based on the Peukert equation.

The Peukert number depends on the battery characteristics. This document describes the procedure to determine the Peukert number for the selected battery.

Once the Peukert number is determined, enter these values in the GUI or web interface. The Alpha Micro 100 will report the remaining battery run time.

The Peukert equation and the remaining battery run time are estimates only. The actual run time may vary based on various parameters like the age and status of the batteries etc.

## 10.2 Determining the Peukert Number

1. Obtain the data sheet of the selected battery.
2. Calculate the nominal load current for the application.

Example: If the load is 85 W and the battery string is 24Vdc, the load current is calculated as  $85W / 24V = 3.54A$ .

3. Find the current discharge ratings table in the data sheet. From the table, pick two current discharge values ( $I_1$  and  $I_2$ ) that are closest to the calculated load current and look up the two discharge hours ( $R_1$  and  $R_2$ ).
4. Use the following formula to calculate the Peukert number:

$$\text{Peukert's number} = n = \frac{\text{Log}(R_2/R_1)}{(\text{Log}(I_1) - \text{Log}(I_2))}$$

### 10.3 Using the Equation

The following example shows how to calculate Peukert number and capacity from a configured battery string.

Consider four CSB EVX1272 batteries connected and configured as shown in the figure below. Two of the four batteries are connected in series, and the two series strings are connected in parallel to the 24Vdc output. The load of the inverter is 85W. For a 24Vdc string the calculated discharge current is 3.54A.

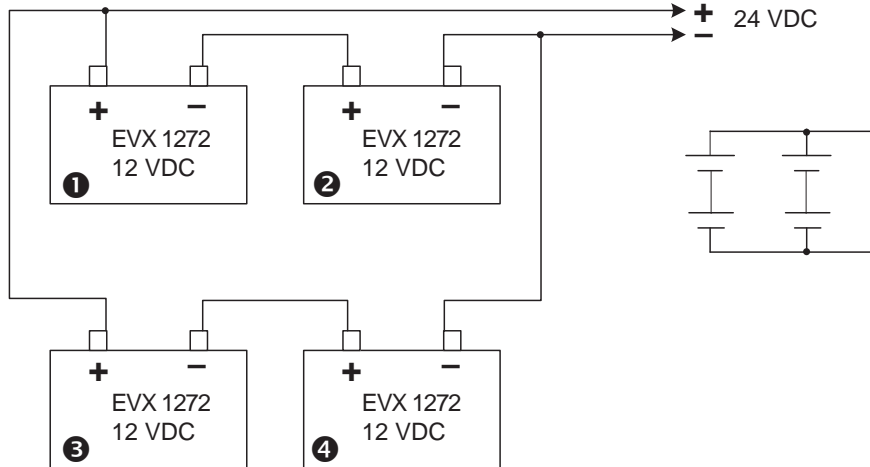

Figure 53 — Battery String Example

The Peukert number and capacity for the above configuration can be determined as follows:

1. Obtain the data sheet of the selected battery. See table below.
2. Find the current discharge ratings table in the data sheet, use 1.75V. From the table, pick two current discharge values ( $I_1$  and  $I_2$ ) that are closest to the calculated load current value. Look up the two discharge hours ( $R_1$  and  $R_2$ ).

Constant Current Nominal Ratings in Amps (@ 25° / 77° F)																
Discharge Time	2min	4min	5min	6min	8min	10min	15min	20min	30min	45min	60min	90min	2hr	3hr	4hr	5hr
<b>1.60V:</b>	74	50	42.2	36.8	29.6	24.9	18	14.2	10.3	7.36	5.84	4.21	3.31	2.37	1.84	1.51
<b>1.67V:</b>	67.3	47.5	40.7	35.8	29	24.5	17.8	14.1	10.2	7.34	5.82	4.2	3.31	2.36	1.83	1.5
<b>1.70V:</b>	64.1	45.9	39.7	35.2	28.6	24.2	17.7	14.1	10.1	7.33	5.81	4.2	3.3	2.36	1.83	1.5
<b>1.75V:</b>	58.3	42.8	37.5	33.6	27.6	23.5	17.4	13.9	10	7.27	5.77	4.17	3.28	2.34	1.82	1.49

3. From the table,  $I_1 = 2.34A$ ,  $I_2 = 1.82A$ ,  $R_1 = 3hrs$ ,  $R_2 = 4hrs$ .

From equation earlier:

$$\text{Peukert's number} = n = \frac{\text{Log}(R_2/R_1)}{(\text{Log}(I_1) - \text{Log}(I_2))}$$

$$n = \frac{\text{Log}(4/3)}{\text{Log}(2.34) - \text{Log}(1.82)} = 1.145$$

## 10.4 Using the Spreadsheet

Download the spreadsheet "Peukert's Parameters Calculator.xls" from [www.alpha.ca](http://www.alpha.ca) website.



### To determine Battery Peukert's Number and Battery Capacity

This spreadsheet assists in determining the Peukert's parameter for a battery string and load. This data will be used by the FXM firmware to estimate the battery run time remaining in back up mode (Inverter mode).

Enter battery string voltage	24	VDC
Enter nominal load on inverter	80	Watts
Enter number of parallel battery strings	2	
Enter battery capacity at 20 hour rate	8.26	AH
Calculated nominal current per battery string	2.19	ADC

From the current discharge table (see table below) enter the two current discharge values ( $I_1$  and  $I_2$ ) closest to the calculated battery string current value and look up the two discharge hours ( $R_1$  and  $R_2$ ).

Discharge Current ( $I_1$ )	2.34	A
Rating 1 ( $R_1$ )	3	Hrs
Discharge Current ( $I_2$ )	1.82	A
Rating 2 ( $R_2$ )	4	Hrs

Peukert's Number = n	1.145
----------------------	-------

Battery Bank Capacity (battery strings in parallel) =	16.520
---	--------

Constant Current Nominal Ratings in Amps (@ 25° / 77° F)																
Discharge Time	2min	4min	5min	6min	8min	10min	15min	20min	30min	45min	60min	90min	2hr	3hr	4hr	5hr
<b>1.60V:</b>	74	50	42.2	36.8	29.6	24.9	18	14.2	10.3	7.36	5.84	4.21	3.31	2.37	1.84	1.51
<b>1.67V:</b>	67.3	47.5	40.7	35.8	29	24.5	17.8	14.1	10.2	7.34	5.82	4.2	3.31	2.36	1.83	1.5
<b>1.70V:</b>	64.1	45.9	39.7	35.2	28.6	24.2	17.7	14.1	10.1	7.33	5.81	4.2	3.3	2.36	1.83	1.5
<b>1.75V:</b>	58.3	42.8	37.5	33.6	27.6	23.5	17.4	13.9	10	7.27	5.77	4.17	3.28	2.34	1.82	1.49

# 11. Maintenance

## 11.1 Updating the Micro 100 Firmware (no Communication Module)

### Material Required

- Laptop with a USB Port and USB cable.

### Before Upgrading

Serial Ports -> Refresh Ports refreshes COM ports in the drop down box top right)



View available serial ports with Serial Ports -> List Ports

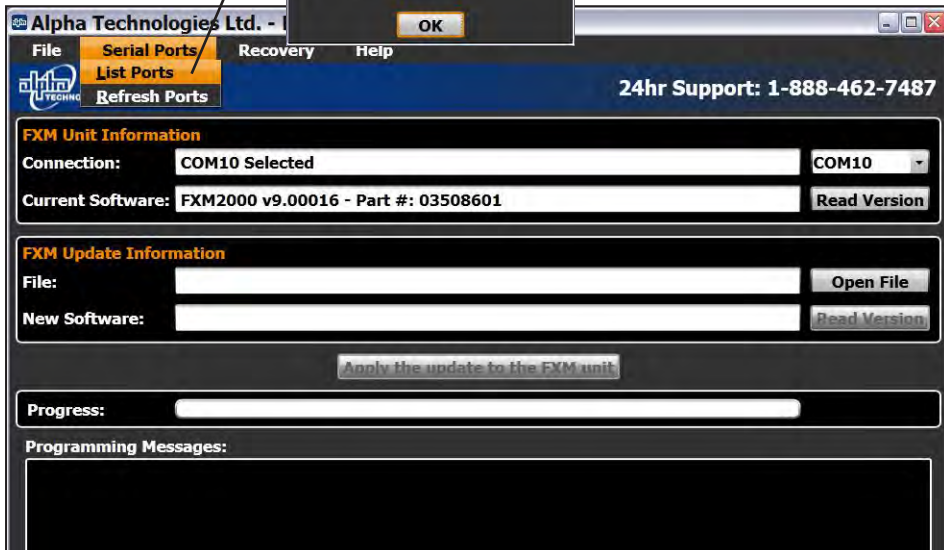

Displays the software version currently installed

Displays the software version about to be installed

- Install the **FXMProgrammer** software onto the laptop.

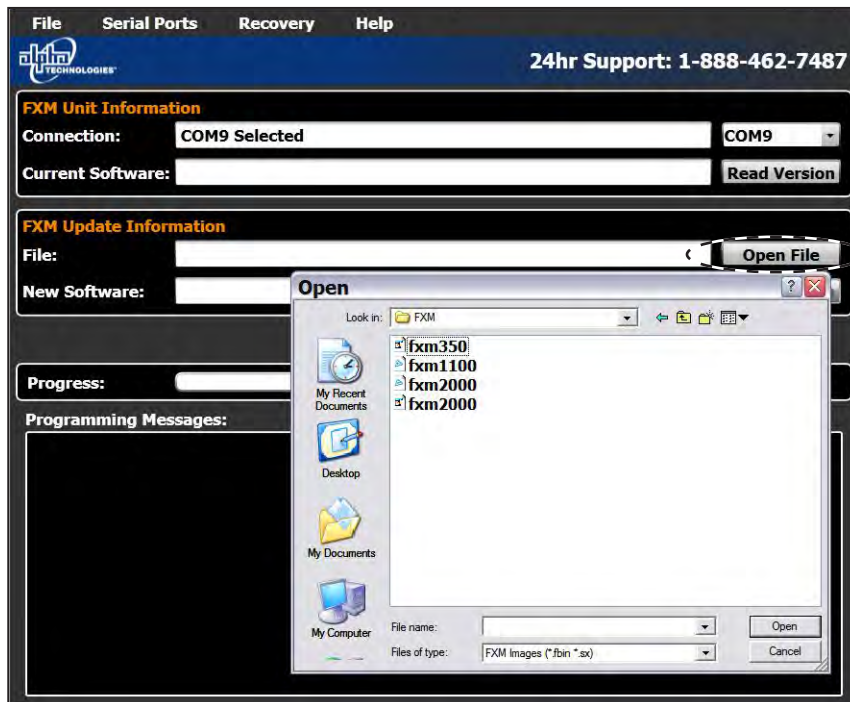

- Copy the upgrade firmware file (only .sx or .fbin files NOT .ezip) to a folder on the laptop.

**Procedure:**

1. On the Alpha Micro 100, put the battery breaker in the OFF position.

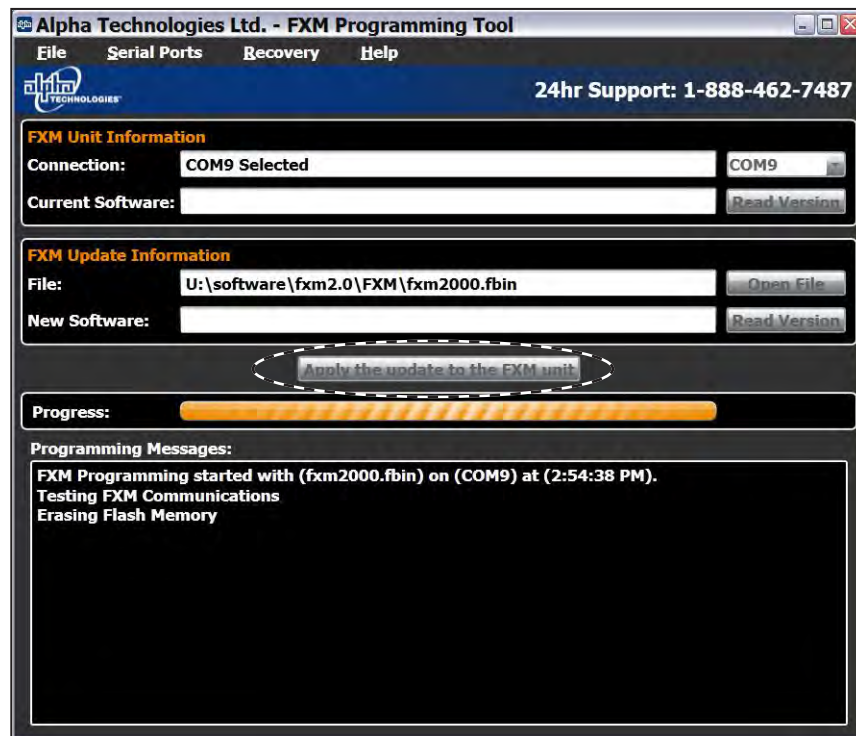

2. Turn off the AC input to the Alpha Micro 100.
3. Short the jumper JP1 on the board.
4. Connect the USB cable between the Alpha Micro 100 and the laptop.
5. Put the battery breaker in the ON position.
6. Start the **FXMProgrammer** software.
7. Select a COM port from the drop-down list of available ports.
8. Click **Open File** to browse to the software file location (only .sx or .fbin files are supported).
9. Click the **Apply the update to the FXM unit** button.
10. Watch the progress bar and the **Programming Messages** window. (If there is a connection or any other kind of error, click **Apply the update again**).

The unit will reset automatically once the upgrade is finished.

11. Close the **FXMProgrammer** software.
12. Put the battery breaker in the OFF position.
13. Remove the jumper on JP1.
14. Put the battery breaker in the ON position.
15. Connect the AC input to the Alpha Micro 100.

Contact Alpha Technologies' Technical Support at 1-800-667-8743 if you have any questions about this procedure.



## 11.2 Testing and Replacing the Batteries

### 11.2.1 Battery life

Batteries lose their ability to store power as they age. Test the batteries regularly to ensure that they can continue to provide reliable service. Battery life is reduced by three major factors:

- Temperature – higher ambient temperatures, especially above 25°C, reduce battery life. For example, an average operating temperature of 27°C will likely reduce the life of the battery by 25%. Ensure that the Alpha Micro 100 and the batteries, are situated in a well ventilated area with adequate temperature control. A cool environment is preferable.
- Number of discharge cycles – the more frequent the batteries are discharged, the shorter the battery life. Frequent power outages increase the need for more frequent battery replacement.
- Depth of discharge – the longer the batteries are required to provide back up power, the shorter the battery life. Frequent full discharging and the associated recharging, reduces battery life. Shut down the electrical load or return to primary power as soon as possible to extend the battery life.

### 11.2.2 Battery Run Time

The chart below shows typical run times (time to full discharge) for the standard batteries supplied with this unit. These runtimes are for batteries in new and good condition. The run time performance will deteriorate over time in a progressively decreasing curve.

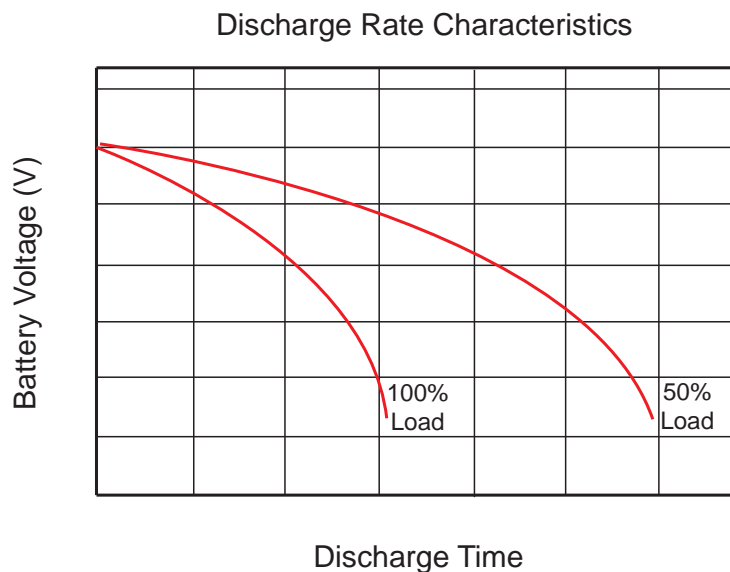

Figure 54 — Typical Discharge Characteristics for Lead Acid Batteries

### 11.2.3 Battery Maintenance

The batteries supplied with this unit are sealed and maintenance free. Regularly ensure that all connections are tight and free of corrosion. The presence of corrosion, swelling of the battery case, or distortion in the shape of the case suggests that the batteries need to be replaced.

### 11.2.4 Replacing the Batteries

Replace the batteries according to the results of the self test or the presence of terminal corrosion, swelling of the battery case, or distortion in the shape of the case. New batteries will normally provide longer run times than older ones. Larger capacity batteries may be available. Contact Alpha Technical Support (1 888 462 7487) to order replacement batteries or to obtain assistance. On-site service may be available in your area.

#### Tools and Materials Required

- AC/DC voltmeter or multimeter.
- Labels or masking tape and marker.
- Slot head screwdriver to fit the terminal blocks.



#### WARNING!

**Read and understand the battery safety instructions in “Safety”.**



#### CAUTION!

**Make sure all the replacement batteries are of the same type and rating. Failure to do so could result in improper charging and damage to the batteries.**

The Alpha Micro 100 cannot provide backup battery power while the batteries are being replaced. If the line becomes unqualified while the batteries are being replaced, the Alpha Micro 100 shuts down and no power is provided to the load.

#### Procedure

1. The Alpha Micro 100 must be in the Line mode (including Buck/Boost). If it isn't, wait until the line is qualified before proceeding.
2. Switch the Alpha Micro 100 into the Bypass State by doing one of the following:
  - From the Alpha UPS Monitor main screen or via the web interface, go to the **UPS Maintenance > Unit Configuration** screen. Switch on the **Bypass Mode** by clicking the **ON** button and then the **Update Configuration** button. The Alpha Micro 100 responds by displaying a “Bypass State” alarm. This is normal and does not indicate a problem. It will clear itself when the Bypass state is subsequently disabled.
3. Switch off the battery circuit breaker.
4. Replace the batteries.
5. Switch on the battery circuit breaker.
6. Switch the Alpha Micro 100 out of the Bypass state by switching the **Bypass Mode OFF**.
7. If USB is not available or an optional communications module is not installed, the power to the loads may have to be turned off while the maintenance is carried out. Turn off the AC circuit breaker and the battery breaker.
8. Replace the batteries.
9. Turn the AC breaker and the battery breaker on.

## 11.3 Preventative Maintenance

Perform preventative maintenance on the Alpha Micro 100 every six to 12 months. For mission critical applications more frequent maintenance should be completed. Proper implementation of the following procedure will ensure that your system continues to provide reliable backup power in the event of a utility power failure.

### 11.3.1 Tools and Materials Required

- Labels and marker to number batteries.
- Conductance meter for optional conductance test.

### 11.3.2 Procedure

1. Inspect the Alpha Micro 100 and wiring for any physical damage. Repair or replace as required.
2. Verify that all connections are securely fastened. Tighten if necessary.
3. Inspect the batteries for cracks or swelling. Replace all four batteries if any of the batteries are cracked or swollen.

### 11.3.3 Operational Test

1. Activate the Alpha Micro 100 self-test function.
2. After passing the self-test, disconnect the AC input to the Alpha Micro 100 to trigger the unit into the backup (Inverter) mode.
3. Let the Alpha Micro 100 operate in the backup mode for approximately 10 minutes and then stop self test.
4. Verify that there is no Low Battery Alarm.
5. Turn the AC breaker on.

For more information refer to section, "7.4 Installing and Wiring the Batteries" on page 22.



### CAUTION!

**A battery that measures 2V lower than the other three batteries in the string probably has a shorted cell. Replace all four batteries.**

**Three batteries in the string measuring the same voltage and one battery measuring several volts higher indicates an open cell in the battery with the higher reading. Replace all four batteries.**

# 12. Troubleshooting

The Alpha Micro 100 is designed for trouble free remote, reliable operation and to operate under wide operating temperature conditions. When connected remotely through the Optional Ethernet communication card, the UPS can provide enough information to troubleshoot the unit remotely.

Alternately, information can be obtained through the USB port, on unit status LEDs when troubleshooting locally at the unit.

**Table U – Troubleshooting Guide**

Symptom	Problem Description	Potential Cause	Troubleshooting
<b>No Output</b>	UPS has no output, loads are not powered.	Utility input is not qualified and batteries have been depleted	Check if utility is out of range. Unit will automatically restart once utility is qualified.
	Overload during backup mode	Utility was lost, unit transferred to back up mode, and over load shut the unit down	Clear the over load. The unit will automatically restart when utility returns. A manual start may be performed in backup mode, through the Web Interface.
	Over temperature has shut the unit down	Utility was lost, unit transferred to backup mode and shutdown due to over temperature.	Allow the unit to cool down and perform a manual start in backup mode, through the Web Interface.
<b>Battery Run Times</b>	Unit does not provide backup power when utility is lost or run time is too short	Breaker(s) tripped	AC and / or DC breaker(s) may have tripped
		Batteries may need to be recharged	Allow batteries to recharge
		Batteries may need replacement	Test and Replace batteries if required
		Ambient temperature is too low	Check if the ambient temperature is too low. The UPS may need battery heater mats.
<b>Alarms</b>	Unit does not qualify AC	The voltage may be out of range or frequency is out of range	Apply Voltage and Frequency with in Specifications
	Low Battery	Battery has discharged and is providing a warning	UPS will shut down once battery is completely discharged.
<b>Faults</b>	Overload	See “No Output Section” above	
	Internal Temperature fault	See “Over Temperature” above	
	Battery Fail	If the battery voltage drops too quickly in back up mode, it may be an indication that one of the cells in the batteries may have shorted internally	Check and Replace battery (batteries).
	Back feed	An internal relay that disconnects the UPS from utility and prevents energy feedback to the grid, has failed.	Cannot be serviced in the field. Contact Alpha Technical Support.
Many of these diagnostics can be performed remotely via the web interface if the communications card is installed and either utility or DC power is available to power the internal electronics of the UPS.			
<b>Communication through USB</b>	USB not communicating with the computer	UPS may have lost utility and the batteries have depleted	UPS will resume normal and communication re-established once utility returns and is qualified.
		Computer may have changed the Com Port number.	Check the newly assigned COM port # and reconnect
<b>Communicating through the Web Interface</b>	Ethernet card has lost communication	UPS may have lost utility and the batteries have depleted	UPS will resume normal and communication re-established once utility returns and is qualified.

## 13. Warranty and Service Information

---

### 13.1 Technical Support

In Canada and the USA, call toll free 1-888-462-7487

Customers outside Canada and the USA, call +1-604-436-5547.

### 13.2 Warranty Statement

For full information details review Alpha's online Warranty Statement at <http://www.alpha.ca/warranty>.

### 13.3 Limited Hardware Warranty

Alpha warrants that for a period of two (2) years from the date of shipment its products shall be free from defects under normal authorized use consistent with the product specifications and Alpha's instructions, unless otherwise specified in the product manual, in which case, the terms of the manual will take precedence

The warranty provides for repairing, replacing or issuing credit (at Alpha's discretion) for any equipment manufactured by it and returned by the customer to the factory or other authorized location during the warranty period.

There are limitations to this warranty coverage. The warranty does not provide to the customer or other parties any remedies other than the above. It does not provide coverage for any loss of profits, loss of use, costs for removal or installation of defective equipment, damages or consequential damages based upon equipment failure during or after the warranty period. No other obligations are expressed or implied. Warranty also does not cover damage or equipment failure due to cause(s) external to the unit including, but not limited to, environmental conditions, water damage, power surges or any other external influence.

The customer is responsible for all shipping and handling charges. Where products are covered under warranty Alpha will pay the cost of shipping the repaired or replacement unit back to the customer.

### 13.4 Battery Warranty

Note that battery warranty terms and conditions vary by battery and by intended use. Contact your Alpha sales representative or the Technical Support team at the above number to understand your entitlements under Battery Warranty.

### 13.5 Warranty Claims

Any claim under this Limited Warranty must be made in writing to Alpha BEFORE sending material back. Alpha will provide Product return instructions upon approval of return request. A Service Repair Order (SRO) and / or Return Authorization (RA) number will be issued ensuring that your service needs are handled promptly and efficiently. Claims must be made online at: <http://www.alpha.ca/web2/service-and-support>.

### 13.6 Service Centers

For a list of international service centers, refer to the Alpha website:

<http://www.alpha.ca/web2/services-and-support>

# 14. Emergency Shutdown Procedure

---

The Alpha Micro 100 UPS contains more than one live circuit. In an emergency, line power may be disconnected at the UPS's input, but AC power can still be present at the output.

1. Switch OFF the input circuit breaker.
2. Switch OFF the battery circuit breaker.
3. Disconnect the AC input power.
4. Disconnect the internal battery string.

### Complete the following for your records:

Serial # \_\_\_\_\_

Options \_\_\_\_\_

Purchase Date \_\_\_\_\_

### This unit was purchased from:

Dealer \_\_\_\_\_

City \_\_\_\_\_

State/Province \_\_\_\_\_

Zip/Postal Code \_\_\_\_\_

Country \_\_\_\_\_

Telephone # \_\_\_\_\_

Fax # \_\_\_\_\_

E Mail Address \_\_\_\_\_











Alpha Technologies Ltd. | 7700 Riverfront Gate, Burnaby, BC V5J 5M4 CANADA

Tel.: Toll Free North America: +1 800 667 8743 | Outside North America +1 604 436 5547 | Technical Support +1 888 462 7487

For more information visit our website at: [www.alpha.com](http://www.alpha.com)

© 2020 Alpha Technologies Ltd. All Rights Reserved. Trademarks and logos are the property of Alpha Technologies Ltd. and its affiliates unless otherwise noted. Subject to revisions without prior notice. E. & O.E.

[www.alpha.com](http://www.alpha.com)

#017-220-J0 Rev C (09/2020)